



Programming Software  
User Manual

---

PC-DSOFT6-M

## ~ WARNING ~

Thank you for purchasing automation equipment from **AutomationDirect.com**<sup>®</sup>, doing business as, **AutomationDirect**. We want your new automation equipment to operate safely. Anyone who installs or uses this equipment should read this publication (and any other relevant publications) before installing or operating the equipment.

To minimize the risk of potential safety problems, you should follow all applicable local and national codes that regulate the installation and operation of your equipment. These codes vary from area to area and usually change with time. It is your responsibility to determine which codes should be followed, and to verify that the equipment, installation, and operation is in compliance with the latest revision of these codes.

At a minimum, you should follow all applicable sections of the National Fire Code, National Electrical Code, and the codes of the National Electrical Manufacturer's Association (NEMA). There may be local regulatory or government offices that can also help determine which codes and standards are necessary for safe installation and operation.

Equipment damage or serious injury to personnel can result from the failure to follow all applicable codes and standards. We do not guarantee the products described in this publication are suitable for your particular application, nor do we assume any responsibility for your product design, installation, or operation.

Our products are not fault-tolerant and are not designed, manufactured or intended for use or resale as on-line control equipment in hazardous environments requiring fail-safe performance, such as in the operation of nuclear facilities, aircraft navigation or communication systems, air traffic control, direct life support machines, or weapons systems, in which the failure of the product could lead directly to death, personal injury, or severe physical or environmental damage ("High Risk Activities"). **AutomationDirect** specifically disclaims any expressed or implied warranty of fitness for High Risk Activities.

For additional warranty and safety information, see the Terms and Conditions section of our catalog. If you have any questions concerning the installation or operation of this equipment, or if you need additional information, please call us at 770-844-4200.

This publication is based on information that was available at the time it was printed. At **AutomationDirect** we constantly strive to improve our products and services, so we reserve the right to make changes to the products and/or publications at any time without notice and without any obligation. This publication may also discuss features that may not be available in certain revisions of the product.

## Trademarks

This publication may contain references to products produced and/or offered by other companies. The product and company names may be trademarked and are the sole property of their respective owners. **AutomationDirect** disclaims any proprietary interest in the marks and names of others.

Copyright 2019, **AutomationDirect.com**<sup>®</sup> Incorporated  
All Rights Reserved

No part of this manual shall be copied, reproduced, or transmitted in any way without the prior, written consent of **AutomationDirect.com**<sup>®</sup> Incorporated. **AutomationDirect** retains the exclusive rights to all information included in this document.

## ~ ADVERTENCIA ~

Gracias por comprar equipo de automatización de **Automationdirect.com**<sup>®</sup>. Deseamos que su nuevo equipo de automatización opere de manera segura. Cualquier persona que instale o use este equipo debe leer esta publicación (y cualquier otra publicación pertinente) antes de instalar u operar el equipo.

Para reducir al mínimo el riesgo debido a problemas de seguridad, debe seguir todos los códigos de seguridad locales o nacionales aplicables que regulan la instalación y operación de su equipo. Estos códigos varían de área en área y usualmente cambian con el tiempo. Es su responsabilidad determinar cuales códigos deben ser seguidos y verificar que el equipo, instalación y operación estén en cumplimiento con la revisión más reciente de estos códigos.

Como mínimo, debe seguir las secciones aplicables del Código Nacional de Incendio, Código Nacional Eléctrico, y los códigos de (NEMA) la Asociación Nacional de Fabricantes Eléctricos de USA. Puede haber oficinas de normas locales o del gobierno que pueden ayudar a determinar cuales códigos y normas son necesarios para una instalación y operación segura.

Si no se siguen todos los códigos y normas aplicables, puede resultar en daños al equipo o lesiones serias a personas. No garantizamos los productos descritos en esta publicación para ser adecuados para su aplicación en particular, ni asumimos ninguna responsabilidad por el diseño de su producto, la instalación u operación.

Nuestros productos no son tolerantes a fallas y no han sido diseñados, fabricados o intencionados para uso o reventa como equipo de control en línea en ambientes peligrosos que requieren una ejecución sin fallas, tales como operación en instalaciones nucleares, sistemas de navegación aérea, o de comunicación, control de tráfico aéreo, máquinas de soporte de vida o sistemas de armamentos en las cuales la falla del producto puede resultar directamente en muerte, heridas personales, o daños físicos o ambientales severos ("Actividades de Alto Riesgo"). **Automationdirect.com** específicamente rechaza cualquier garantía ya sea expresada o implicada para actividades de alto riesgo.

Para información adicional acerca de garantía e información de seguridad, vea la sección de Términos y Condiciones de nuestro catálogo. Si tiene alguna pregunta sobre instalación u operación de este equipo, o si necesita información adicional, por favor llámenos al número 770-844-4200 en Estados Unidos.

Esta publicación está basada en la información disponible al momento de impresión. En **Automationdirect.com** nos esforzamos constantemente para mejorar nuestros productos y servicios, así que nos reservamos el derecho de hacer cambios al producto y/o a las publicaciones en cualquier momento sin notificación y sin ninguna obligación. Esta publicación también puede discutir características que no estén disponibles en ciertas revisiones del producto.

## Marcas Registradas

Esta publicación puede contener referencias a productos producidos y/u ofrecidos por otras compañías. Los nombres de las compañías y productos pueden tener marcas registradas y son propiedad única de sus respectivos dueños. **Automationdirect.com**, renuncia cualquier interés propietario en las marcas y nombres de otros.

**PROPIEDAD LITERARIA 2019, AUTOMATIONDIRECT.COM<sup>®</sup> INCORPORATED**

**Todos los derechos reservados**

No se permite copiar, reproducir, o transmitir de ninguna forma ninguna parte de este manual sin previo consentimiento por escrito de **Automationdirect.com<sup>®</sup> Incorporated**. **Automationdirect.com** retiene los derechos exclusivos a toda la información incluida en este documento. Los usuarios de este equipo pueden copiar este documento solamente para instalar, configurar y mantener el equipo correspondiente. También las instituciones de enseñanza pueden usar este manual para propósitos educativos.

## ~ AVERTISSEMENT ~

Nous vous remercions d'avoir acheté l'équipement d'automatisation de **Automationdirect.com**<sup>®</sup>, en faisant des affaires comme, **AutomationDirect**. Nous tenons à ce que votre nouvel équipement d'automatisation fonctionne en toute sécurité. Toute personne qui installe ou utilise cet équipement doit lire la présente publication (et toutes les autres publications pertinentes) avant de l'installer ou de l'utiliser.

Afin de réduire au minimum le risque d'éventuels problèmes de sécurité, vous devez respecter tous les codes locaux et nationaux applicables régissant l'installation et le fonctionnement de votre équipement. Ces codes diffèrent d'une région à l'autre et, habituellement, évoluent au fil du temps. Il vous incombe de déterminer les codes à respecter et de vous assurer que l'équipement, l'installation et le fonctionnement sont conformes aux exigences de la version la plus récente de ces codes.

Vous devez, à tout le moins, respecter toutes les sections applicables du Code national de prévention des incendies, du Code national de l'électricité et des codes de la National Electrical Manufacturer's Association (NEMA). Des organismes de réglementation ou des services gouvernementaux locaux peuvent également vous aider à déterminer les codes ainsi que les normes à respecter pour assurer une installation et un fonctionnement sûrs.

L'omission de respecter la totalité des codes et des normes applicables peut entraîner des dommages à l'équipement ou causer de graves blessures au personnel. Nous ne garantissons pas que les produits décrits dans cette publication conviennent à votre application particulière et nous n'assumons aucune responsabilité à l'égard de la conception, de l'installation ou du fonctionnement de votre produit.

Nos produits ne sont pas insensibles aux défaillances et ne sont ni conçus ni fabriqués pour l'utilisation ou la revente en tant qu'équipement de commande en ligne dans des environnements dangereux nécessitant une sécurité absolue, par exemple, l'exploitation d'installations nucléaires, les systèmes de navigation aérienne ou de communication, le contrôle de la circulation aérienne, les équipements de survie ou les systèmes d'armes, pour lesquels la défaillance du produit peut provoquer la mort, des blessures corporelles ou de graves dommages matériels ou environnementaux («activités à risque élevé»). La société **AutomationDirect** nie toute garantie expresse ou implicite d'aptitude à l'emploi en ce qui a trait aux activités à risque élevé.

Pour des renseignements additionnels concernant la garantie et la sécurité, veuillez consulter la section Modalités et conditions de notre documentation. Si vous avez des questions au sujet de l'installation ou du fonctionnement de cet équipement, ou encore si vous avez besoin de renseignements supplémentaires, n'hésitez pas à nous téléphoner au 770-844-4200.

Cette publication s'appuie sur l'information qui était disponible au moment de l'impression. À la société **AutomationDirect**, nous nous efforçons constamment d'améliorer nos produits et services. C'est pourquoi nous nous réservons le droit d'apporter des modifications aux produits ou aux publications en tout temps, sans préavis ni quelque obligation que ce soit. La présente publication peut aussi porter sur des caractéristiques susceptibles de ne pas être offertes dans certaines versions révisées du produit.

## Marques de commerce

La présente publication peut contenir des références à des produits fabriqués ou offerts par d'autres entreprises. Les désignations des produits et des entreprises peuvent être des marques de commerce et appartiennent exclusivement à leurs propriétaires respectifs. **AutomationDirect** nie tout intérêt dans les autres marques et désignations.

Copyright 2019, **Automationdirect.com**<sup>®</sup> Incorporated

**Tous droits réservés**

Nulle partie de ce manuel ne doit être copiée, reproduite ou transmise de quelque façon que ce soit sans le consentement préalable écrit de la société **Automationdirect.com**<sup>®</sup> Incorporated. **AutomationDirect** conserve les droits exclusifs à l'égard de tous les renseignements contenus dans le présent document.

# MANUAL REVISIONS

---

Please include the Manual Number and the Manual Issue, both shown below, when communicating with Technical Support regarding this publication.

Title: *DirectSOFT 6 Programming Software User Manual*

Manual Number: PC-DSOFT6-M

Issue: 2nd Edition Rev. B

Issue Date: 8/19

Publication History		
Issue	Date	Description of Changes
1st Edition	10/14	Original issue
2nd Edition	9/17	Added D4-454 and minor changes
2nd Ed. Rev. A	12/18	Added D2-262 and minor changes
2nd Ed. Rev. B	8/19	Added Appendix C and misc. changes



# **TABLE OF CONTENTS**

---

## **Chapter 1 - Introduction**

<b>Introduction</b> .....	<b>1-2</b>
The Purpose of this Manual.....	1-2
Who Can and Should Use <b>DirectSOFT6</b> .....	1-2
Only One <b>DirectSOFT6</b> Version.....	1-3
Supplemental Manuals.....	1-4
Technical Support .....	1-4
<b>Conventions Used</b> .....	<b>1-5</b>
Menu Selections and Keystrokes.....	1-5
Key Topics for Each Chapter.....	1-5

## **Chapter 2 - Quick Start**

<b>Getting to Know Windows</b> .....	<b>2-2</b>
System Requirements .....	2-2
Power Supply .....	2-2
<b>DirectSOFT6</b> Package Contents.....	2-2
<b>Installation of DirectSOFT6</b> .....	<b>2-3</b>
Step 1: Load the CD .....	2-3
Step 2: Exit all other Windows Applications.....	2-3
Step 3: Enter the Product Key Code.....	2-4
Step 4: Installing an Upgrade.....	2-4
Step 5: License Agreement.....	2-5
Step 6: Enter the Customer Information.....	2-5
Step 7: Select the Type of Installation .....	2-6
Step 8: Ready to Install.....	2-6

## Table of Contents

---

Step 9: Installation is Complete.....	2-7
If an Upgrade.....	2-7
<b>Getting Started.....</b>	<b>2-8</b>
<b>Welcome to <i>DirectSOFT100</i> .....</b>	<b>2-11</b>
What is <i>DirectSOFT100</i> ? .....	2-11
Using <i>DirectSOFT100</i> ?.....	2-12
<b>Begin Editing a Program .....</b>	<b>2-13</b>
Step 1: Start a New Project .....	2-13
Step 2: Select Edit Mode .....	2-16
Step 3: Enter an Input Element .....	2-18
Step 4: Enter an Output Element .....	2-19
Step 5: Enter the End Rung .....	2-20
<b>Establish the Communication Link.....</b>	<b>2-23</b>
Connect the PC to the PLC .....	2-23
Step 1: Select the Port.....	2-23
Step 2: Select the PLC.....	2-24
Step 3: Choose the Protocol and Node Address.....	2-24
Step 4: Name the Link .....	2-25
<b>Monitor the Program .....</b>	<b>2-29</b>
 <b>Chapter 3 - Managing Projects</b>	
<b>Get Started Using <i>DirectSOFT6</i>.....</b>	<b>3-2</b>
Understanding the Launch Window .....	3-2
<b>Create a New Project.....</b>	<b>3-4</b>
New Program.....	3-4
Enter the New Project Information .....	3-4
<b>Importing Projects.....</b>	<b>3-5</b>
Program Documentation Mapping from TISOFT and Logicmaster .....	3-6
<b>Copy or Save Existing <i>DirectSOFT</i> Files .....</b>	<b>3-7</b>
 <b>Chapter 4 - Programming Environment</b>	
<b>Offline Toolbar Components .....</b>	<b>4-2</b>
Offline Toolbar .....	4-2

**Online Toolbar Components..... 4-5**  
    Online Toolbar ..... 4-5

**Additional Toolbars ..... 4-6**  
    The File Toolbar ..... 4-7  
    The Edit Toolbar..... 4-8  
    The Search Toolbar ..... 4-9  
    The View Toolbar ..... 4-10  
    The Tools Toolbar ..... 4-11  
    The PLC Toolbar..... 4-12  
    The PLC Diagnostics Toolbar..... 4-13  
    The PLC Setup Toolbar..... 4-13  
    The Debug Toolbar ..... 4-15  
    The Window Toolbar..... 4-16  
    The Help Toolbar ..... 4-17  
    The Custom Toolbar ..... 4-17  
    PLC System Information ..... 4-19  
    Communication/Link Information..... 4-20  
    PLC Mode ..... 4-20  
    Program Memory Usage ..... 4-20  
    PLC Type..... 4-20  
    Program Cursor Location..... 4-20

**The Options Dialog ..... 4-21**  
    Ladder Options ..... 4-22  
    Global Options..... 4-23

**Colors in *DirectSOFT6* ..... 4-24**  
    Select New Colors ..... 4-24  
    Color Selections ..... 4-25  
    The Default Settings..... 4-25  
    Monochrome ..... 4-25  
    Colors Conveying Information..... 4-26  
    Select a Theme..... 4-27

**The Ladder Palette ..... 4-28**  
    Be Familiar with the Ladder Palette ..... 4-28

**The Split Screen Feature ..... 4-30**



Split Screen Bar .....	4-30
<b>The New Window Feature.....</b>	<b>4-31</b>

## Chapter 5 - Edit a Program

<b>I/O Configuration .....</b>	<b>5-2</b>
<b>Referencing Program Elements.....</b>	<b>5-4</b>
Data Types .....	5-4
Aliases .....	5-5
Timer/Counter Current Values.....	5-5
Accessing I/O Points as Memory Locations.....	5-5
<b>Entering Program Instructions.....</b>	<b>5-6</b>
The Instruction Editor.....	5-6
Using the Ladder Palette .....	5-8
Opening the Instruction Browser.....	5-8
<b>Shortcuts for Entering Instructions.....</b>	<b>5-11</b>
Entering NO and NC Contacts .....	5-12
Entering Instructions in Parallel.....	5-13
Entering Power Flow Instructions .....	5-14
Entering Special Case Elements .....	5-16
End Coil .....	5-17
Setting and Resetting a Bit .....	5-18
Using Floating Point Math.....	5-18
<b>Drawing/Deleting Connecting Lines .....</b>	<b>5-19</b>
Drawing the Lines .....	5-19
Create Midline Outputs.....	5-20
Deleting Connecting Lines .....	5-20
<b>Selecting Rungs for Deleting, Cutting or Copying.....</b>	<b>5-21</b>
<b>Deleting Rungs .....</b>	<b>5-22</b>
<b>Copying Rungs.....</b>	<b>5-23</b>
<b>Cut and Paste Rungs .....</b>	<b>5-25</b>
<b>Merge (Combine) Rungs.....</b>	<b>5-26</b>
<b>Inserting Columns, Rows and Rungs .....</b>	<b>5-27</b>
Insert a Column to Add an Instruction .....	5-27

Insert a Row or Rung..... 5-28

**Using Search and Replace ..... 5-29**

    Using the Object Section..... 5-29

    The Search Range Section ..... 5-30

    The Document Section..... 5-30

    The Object Table Section ..... 5-30

**Common Mistakes ..... 5-31**

    Failure to Enter the Edit Mode..... 5-31

    AND above a Join..... 5-31

    Forgetting to Select Rungs ..... 5-31

## Chapter 6 - Documentation

**Turn Documentation On and Off..... 6-2**

    The Options Dialog ..... 6-2

    Documentation Selections..... 6-3

    General Documentation ..... 6-3

**Using the Documentation Editor ..... 6-4**

    Using the Scroll Buttons ..... 6-4

    Copying Documentation Between Elements..... 6-5

**Documenting and Assigning Nicknames ..... 6-6**

    Create an Unassigned Nickname ..... 6-6

    Assign the Nickname to an Element ..... 6-6

**Entering Rung Comments ..... 6-9**

    Comments are Free-form ..... 6-9

    Selecting Rungs for Comments ..... 6-9

    Using the Scroll Buttons ..... 6-10

    Use the Editing Keys..... 6-10

    Move Rung Comments ..... 6-11

**Entering Stage Comments ..... 6-12**

    Use Stage View..... 6-12

    Comments are Free-form ..... 6-13

    Selecting Stages to Comment ..... 6-13

    Editing the Comments ..... 6-13

## Table of Contents

---

<b>Importing and Exporting .....</b>	<b>6-14</b>
Exporting Program Documentation.....	6-14
Export Element Documentation .....	6-16
Export Rung Comments.....	6-18
Importing a Program.....	6-19
Importing Element Documentation.....	6-22
Importing Program Comments .....	6-24
Insert Instructions.....	6-24
Restore.....	6-27
<b>Prevent Documentation Loss .....</b>	<b>6-28</b>
Save Project.....	6-28
Backup Project .....	6-29

## Chapter 7 - Other Views

<b>Tabbed Views .....</b>	<b>7-2</b>
The Primary Views.....	7-2
<b>Stage (RLL<sup>PLUS</sup>) View.....</b>	<b>7-4</b>
Troubleshooting RLLplus vs. RLL.....	7-4
Stage Components.....	7-4
<b>Mnemonic View.....</b>	<b>7-5</b>
Handheld Programmer Aid.....	7-5
<b>Cross Reference (XRef) View.....</b>	<b>7-6</b>
XRef Mode .....	7-6
Change the XRef Query .....	7-7
XRef Toolbar .....	7-8
Usage Mode.....	7-9
Usage Mode Toolbar.....	7-9
XRef DB.....	7-10
<b>PID View.....</b>	<b>7-11</b>
PID Setup.....	7-11
<b>Trend View.....</b>	<b>7-13</b>
Creating a new Trend View.....	7-13
Output Window .....	7-15

**Bookmark..... 7-17**

**View Terminology..... 7-18**

**Chapter 8 - Printing**

**Print the Current View ..... 8-2**

    Print the Ladder View..... 8-2

    Other Print Views ..... 8-3

**Print Multiple Views ..... 8-5**

**Print View Common Setup..... 8-7**

**Using Print Preview ..... 8-8**

    Print Preview Setup ..... 8-8

    Print Preview ..... 8-9

**Print Troubleshooting ..... 8-10**

    Parts of Program not Printed ..... 8-10

    Program Prints "Garbage" ..... 8-10

    DirectSOFT6 Crashes..... 8-10

    Print Setup Dialog ..... 8-11

**Chapter 9 - Setup and Manage Communication Links**

**Establish the Communications Link ..... 9-2**

**Setup a Serial Link ..... 9-2**

    Link Status..... 9-6

**Setup an Ethernet Link..... 9-7**

    NetEdit3 Troubleshooting Tips ..... 9-12

**Setup a Modem Link ..... 9-14**

    Modem Setup ..... 9-14

    Configuring the Link ..... 9-18

**Comm Link Options..... 9-22**

**Going Online ..... 9-24**

    Connect the PLC ..... 9-24

    Use the Project Folder ..... 9-24

    Use the Link ..... 9-24

## Chapter 10 - Debugging and Monitoring

<b>Monitor with Data View</b> .....	<b>10-2</b>
Using Data View.....	10-2
Open a New Data View Window.....	10-2
A Closer Look.....	10-3
Data View Options.....	10-4
Select Bits for Display.....	10-5
Data View Documentation Options.....	10-7
Apply Options.....	10-7
Data View Mode Options.....	10-8
Make Data View Entries.....	10-8
Data Format and Size.....	10-10
Write the Edits.....	10-11
Auto-increment.....	10-12
Editing Entries.....	10-12
Save the Data View Window.....	10-13
Using Pause Bits.....	10-14
Use Override Bits to Control I/O (DL05, DL06, D2-240, D2-250-1, D2-260, D2-262, D3-350, D4-450, D4-454) ...	10-15
<b>Change Value Dialog</b> .....	<b>10-16</b>
Use the Change Value Dialog.....	10-16
Specify an Element Reference or Nickname.....	10-17
Enter a New Value.....	10-18
<b>Using the Memory Editor</b> .....	<b>10-20</b>
Select the Locations to View.....	10-20
<b>Test Mode Operations for Debugging</b> .....	<b>10-22</b>
Select Test Mode.....	10-22
Test Program Operations.....	10-23
The Test Operations Window.....	10-24
<b>Trap Monitor</b> .....	<b>10-25</b>
Access the Trap Monitor.....	10-25
Use with Data View.....	10-27
<b>Stack Monitor (D4-440 Only)</b> .....	<b>10-28</b>
Access the Stack Monitor.....	10-28

# Table of Contents

---

<b>Trend View</b> .....	<b>10-29</b>
Using the Trend View .....	10-29
The Crosshair Cursor .....	10-30
<b>Check <i>Direct</i>SOFT6 File Revision</b> .....	<b>10-33</b>

## Appendix A - Protocols and Cable Diagrams

<b>Protocols and Cables</b> .....	<b>A-2</b>
<b>Programming Cable Diagrams</b> .....	<b>A-6</b>

## Appendix B - Communications Troubleshooting

<b>Communications Resources</b> .....	<b>B-2</b>
Startup .....	B-2
USB-TO-SERIAL Devices .....	B-9
DUMP (used to troubleshoot SERIAL and MODEM links).....	B-10
<b>Editing the DSxxx.ini file</b> .....	<b>B-10</b>
Windows XP and Windows 7/8/10 .....	B-10
Windows Vista .....	B-11
UAC = ON .....	B-11
UAC = OFF. ....	B-12
Other Editable Parameters .....	B-12
<b>Other Possible Issues</b> .....	<b>B-15</b>
How to Change USB-Serial Port Assignment .....	B-15
“PORT UNAVAILABLE OR IN USE” .....	B-15
Laptop AC Adapter Issue .....	B-15

## Appendix C - Hardware - Software Compatibility Table

<b>Hardware – Software Compatibility Table</b> .....	<b>C-2</b>
--	------------



# CHAPTER

# 1

# INTRODUCTION

---

**In This Chapter...**

Introduction..... 1-2

Conventions Used..... 1-5

# Introduction

## The Purpose of this Manual

This manual describes how to use the *DirectSOFT6* software for programming and monitoring any of the *DirectLogic* and compatible CPUs. *This manual will not teach you how to develop a relay ladder logic (RLL) program or attempt to familiarize you with the instruction sets of the CPUs.* Please refer to the applicable PLC user manual for the RLL instructions. The Quick Start chapter will show the first time user how to get started using *DirectSOFT6*. The balance of the manual will detail all of the programming tools made available to the user.

## Who Can and Should Use *DirectSOFT6*

If you have a PLC belonging to the *DirectLOGIC* CPU family, you can use *DirectSOFT6* to manage your existing ladder logic programs and to create new ones. The families of PLCs that currently exist under this description are shown below.

### DirectLOGIC PLC Family



**DL05 CPUs**  
Two built-in ports  
Max. baud = 38.4 K

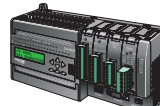

**DL06 CPUs**  
Two built-in ports  
Max. baud = 38.4 K



**DL105 CPUs**  
One built-in port  
Fixed baud = 9.6 K

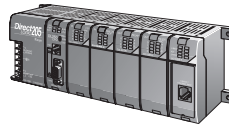

**DL205 CPUs**  
One built-in port D2-230; fixed baud = 9.6 K  
Two built-in ports D2-240; max. baud = 19.2 K  
Two built-in ports D2-250(-1)/D2-260/D2-262 max baud =38.4 K



**DL305 CPUs**  
D3-330 requires D3-232-DCU; max. baud = 19.2 K Two built-in ports D3-340/D3-350; max. baud = 38.4 K



**DL405 CPUs**  
Two built-in ports D4-430/D4-440; max. baud = 19.2 K  
Four built-in ports D4-450/D4-454; max. baud = 38.4 K



Besides being easy to use, *DirectSOFT6* includes the following new features:

Crisp new graphics-based displays in Ladder View and Stage View with alpha-blended Block Cursors.

Color Setup dialog now offers selection of over 16 million colors -- along with the ability to configure Block Cursor and Ladder View Box colors.

Now ZOOM IN / ZOOM OUT to eleven (11) levels via new drop-down Zoom control on the main offline toolbar.

New Trend View tool which is a new debugging tool for tracking multiple elements values over time.

New graphical indicator denotes edge-triggered (vs. level-triggered) Boxes and IBoxes in Ladder View.

*DirectSOFT* now automatically Checks for Updates on startup. Also added ability to manually “Check for Updates...” under the Help menu.

Over 40 new IBoxes including: MOVER - Move Real, FILTERD - Filter Over Time - BCD Double and DECBYBCD - Decrement by BCD

Secure installation of program to meet safety needs.

See the chart below for the PLCs and the supporting firmware revisions required for the new IBox instructions.

### Only One *DirectSOFT6* Version

There is only one *DirectSOFT* version for the *DirectLOGIC* PLC family. All licensed versions of *DirectSOFT* programming software (v1.0 - v5.0) can be upgraded to version 6. Also, all programs created with older versions of *DirectSOFT* are compatible with *DirectSOFT6*.

PLC	Firmware
DL05	5.10
DL06	2.10
D2-250-1	4.60
D2-260	2.40
D2-262	1.00
D4-450	3.30
D4-454	1.01

### Supplemental Manuals

Depending on the products you have purchased, there may be other manuals that are necessary to use for your application.

#### User Manuals

DL05 User Manual – D0-USER-M  
DL06 User Manual – D0-06USER-M  
DL105 User Manual – D1-USER-M  
DL205 User Manual – D2-USER-M  
DL305 User Manual – D3-USER-M  
DL350 User Manual – D3-350-M  
DL405 User Manual – D4-USER-M  
DL454 User Manual – D4-454-M



*NOTE: AutomationDirect also has many associated product user manuals, such as analog system manuals, which will assist you with your application.*

---

### Technical Support

We realize that even though we strive to do our best, we may have arranged our information in such a way that you cannot find what you are looking for. First, check these resources for help in locating the information:

Table of Contents – chapter and section listing of contents, in the front of this manual  
Appendices – reference material for key topics, near the end of this manual  
Index – reference for key items

You can also check our online resources for the latest product support information:

Our website is: <http://www.automationdirect.com>

If you still need assistance, please call us at 770-844-4200 or visit our technical support page at: <http://support.automationdirect.com>. Our technical support team will be available to work with you to answer your questions. They are available Monday through Friday from 9:00 A.M. to 6:00 P.M. Eastern Standard Time.

## Conventions Used



When the “notepad” symbol is shown in the left-hand margin, the paragraph to its immediate right will be a special note. The word **NOTE**: in boldface will mark the beginning of the text.



When the “exclamation mark” symbol is shown in the left-hand margin, the paragraph to its immediate right will be a warning. This information could prevent injury, loss of property, or even death (in extreme cases).

The word **WARNING**: in boldface will mark the beginning of the text.



Whenever the “lightbulb” is shown in the left-hand margin, the paragraph to its immediate right will provide a **special tip**. The word **TIP**: in boldface will mark the beginning of the text.

### Menu Selections and Keystrokes

When the software requires you to use a particular keystroke or menu selection, the written instructions will be in boldface type. Combination keystrokes will be separated with a plus (+) sign. For example, **Ctrl + C** means: Hold down the **Ctrl** key and press the **C** key. Menu selections can also be combinations and separated by a greater-than sign. For example, **File > Write Program > to Disk** is a menu selection combination.

### Key Topics for Each Chapter

The beginning of each chapter will list the key topics that can be found in that chapter.

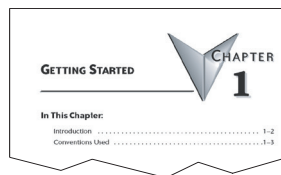

# QUICK START

---



# CHAPTER 2

## In This Chapter...

Getting to Know Windows.....	2-2
Installation of <i>DirectSOFT6</i> .....	2-3
Getting Started.....	2-8
Welcome to <i>DirectSOFT100</i> .....	2-11
Begin Editing a Program .....	2-13
Establish the Communication Link.....	2-23
Monitor the Program .....	2-29

## Getting to Know Windows

### System Requirements

*DirectSOFT* Programming Software runs under 32-bit or 64-bit Windows operating systems. It's a good idea to understand the operating system for your computer.

Please check the system requirements when choosing your PC configuration on our web site: <https://support.automationdirect.com/downloads.html>.

### Power Supply

It is recommended that the computer which *DirectSOFT* operates on has some form of power surge protection. A quality surge protector will protect your computer from most surges and spikes; however, an uninterruptible power supply (UPS) will provide the best protection. A UPS provides isolation between the AC power source and the computer. It also has a battery backup for blackout and brownout conditions.

### *DirectSOFT6* Package Contents

Now is the time to review the contents of your *DirectSOFT6* software package you should have the following items:

- CD ROM

- Programming User Manual

## Installation of *DirectSOFT6*

### Step 1: Load the CD

*DirectSOFT* Programming Software for *DirectLOGIC* PLCs is available on the AutomationDirect CD. To install *DirectSOFT6*, insert the AutomationDirect CD into your PC's CD drive. Select "Open folder when autoplay dialog appears, or navigate to the CD drive, and select the SetupDS6 executable.

### Step 2: Exit all other Windows Applications

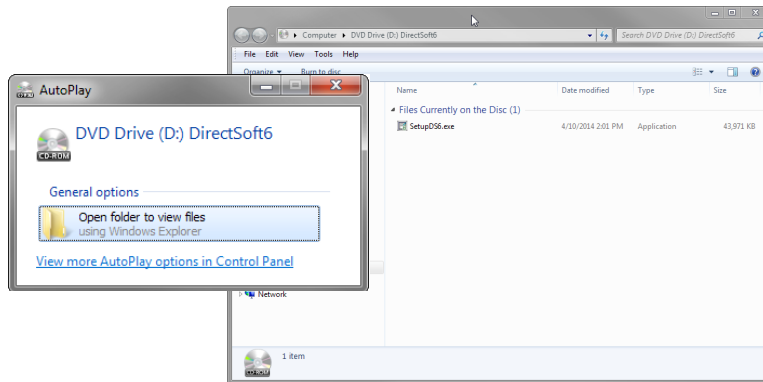

The dialog below issues a reminder to exit all other Window applications. If you are unsure of the programs that may be running, open the Task Manager by pressing the Ctrl-ALT-Delete keys at the same time. Close any opened applications by selecting them and clicking on the **Close** button of the Task Manager. Click on the **OK** button to proceed with the installation.

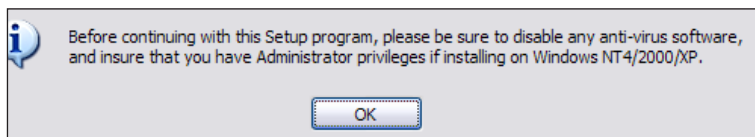

### Step 3: Enter the Product Key Code

From this window, enter the **Product Key** that was e-mailed to you (or the one who purchased the software), or phone 1-800-633-0405 and get the Product Key from either sales or technical support if you did not receive it. This software package is protected by this Product Key code. Only licensed users that have a Product Key code may install the software. Enter the Product Key using all caps and any dashes shown then click the **Next** button.

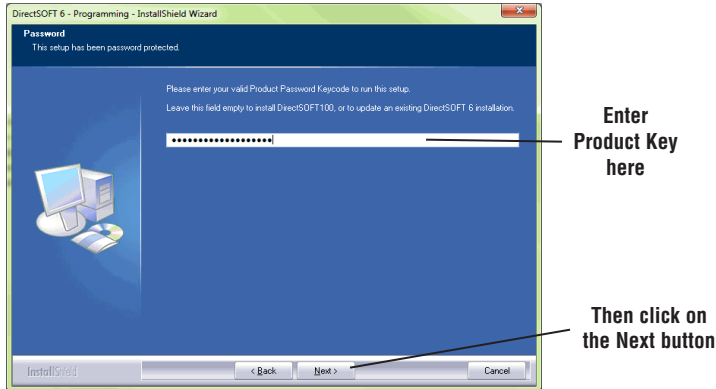

### Step 4: Installing an Upgrade

If you are installing the *DirectSOFT* upgrade version, setup will search your PC to look for a previous version of *DirectSOFT*. If a previous *DirectSOFT* version is not found, you will be prompted to enter a valid product key code from a previous version of *DirectSOFT*.

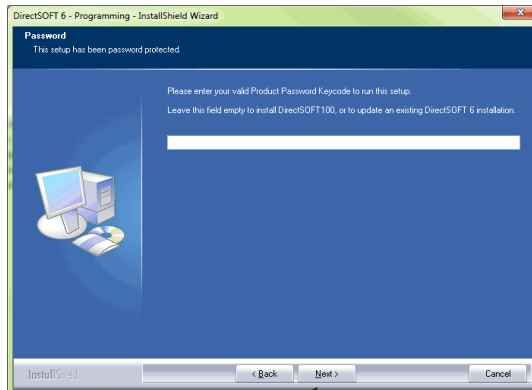

Click here to proceed with the *DirectSOFT6* installation

## Step 5: License Agreement

The wizard displays the “Software License Agreement” shown below. Read the agreement and select **I accept the terms of the license agreement**. Click **Next** to continue with the installation. If you do not accept the license agreement, cancel the installation.

## Step 6: Enter the Customer Information

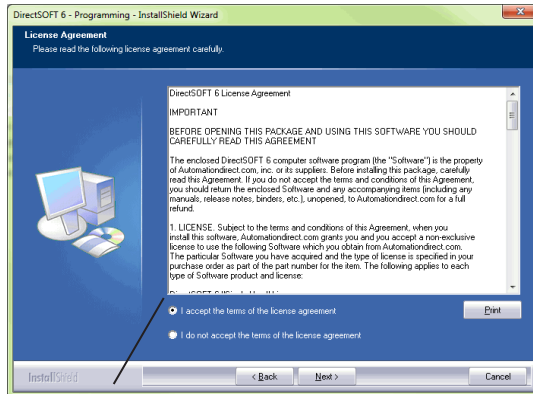

Click here if you agree with the License Agreement’s terms.

The “Customer Info” window requests the user name and company. Enter the name of the person assigned to the *DirectSOFT* Programming Software and the name of your company. Click the **Next** button to continue with the *DirectSOFT* installation.

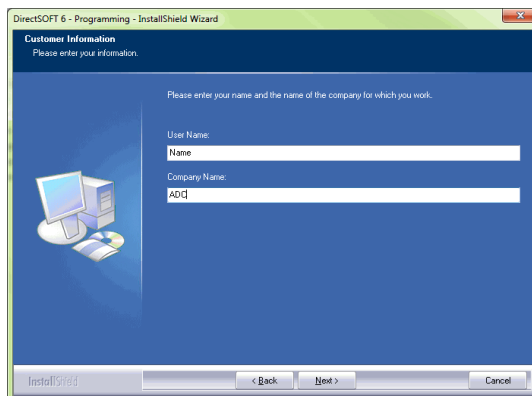



### Step 7: Select the Type of Installation

The wizard now displays the “Setup Type” window. This window allows you to select either the “Complete” or the “Custom” type of installation. Complete is the most common selection. Custom allows you to select the optional components you want. It is recommended that you select Complete for your *DirectSOFT* installation. Click on the **Next** button to proceed with installation.

### Step 8: Ready to Install

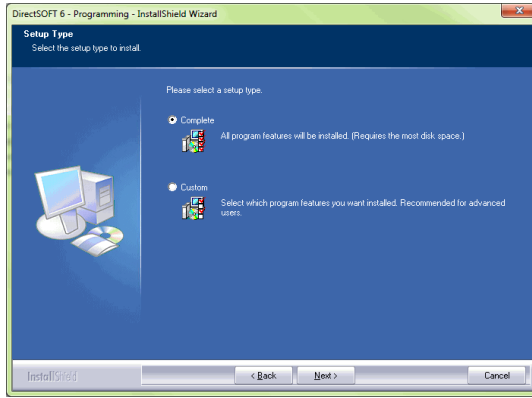

The wizard continues with the “Ready to Install the Program” window appears. Verify the folder name where the *DirectSOFT* files are to be stored. If this is the desired folder, click on the **Next** button to continue with the installation.

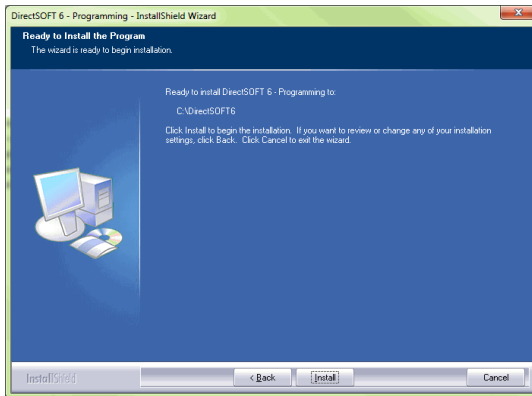

The following window lets you know that the *DirectSOFT6* Programming Software is being installed onto your computer.

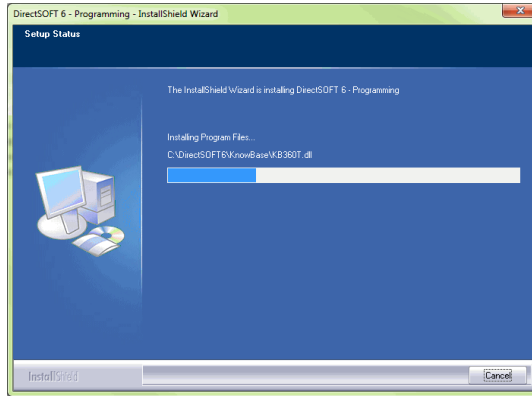

### Step 9: Installation is Complete

The wizard now displays the “InstallShield Wizard Complete” window shown below. Click on the **Finish** button.

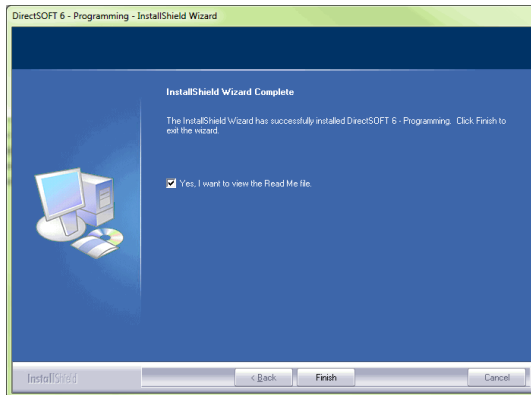

### If an Upgrade

If an older *DirectSOFT* version is found during the installation, you will be prompted to make *DirectSOFT6* the default projects folder. You will then be asked if you want the existing projects copied to the *DirectSOFT6* projects folder.

# Getting Started



Before beginning to edit a program, you need to open **DirectSOFT**. Click on the **DirectSOFT6** icon located on your desktop screen to open the DSLaunch window. You can also click on **Start** located in the left-hand corner of the computer monitor. Now select **Programs**, find **DirectSOFT6**, then select **DSLUNCH6** in the drop-down window. If your computer is connected to the Internet, the following **DSLaunch** window will appear with **What's New**. What's New will have useful information for the user from the **AutomationDirect** website.

DirectSOFT on the Web

The screenshot shows the DSLaunch application window. The left sidebar contains a tree view of the system's file structure, including folders for Applications, Utilities, and Projects. The main window area is titled 'DSLaunch' and features a blue header with the text 'DirectSOFT on the Web' and a 'Help' button. Below the header, there is a section titled 'DirectSOFT version 6.1 is now available!' which includes a small image of the software box and text stating: 'The latest version of the DirectSOFT Programming Software is now available for purchase on the AutomationDirect web store. Existing users of DirectSOFT v6.x can use Help-> Check for Updates to download the latest version. Customers with DirectSOFT v5.3 or earlier can purchase an upgrade that can be applied to any previous version of DirectSOFT.' Below this, there are several bullet points listing new features: 'NEW! support for the new D4-454 CPU with 32K of Ladder Memory, Port 2 supports MODBUS Protocol, and 38400 baud rate for all protocols on all 3 ports', 'NEW! Updated CTRIO Workbench and ERM Workbench with D4-454 support', 'NEW! Trend Views', 'NEW! 40+ New I-Boxes', 'NEW! Box Instruction Leg Labels', 'NEW! Automatic Check for Updates', and 'NEW! Faster Status Updates'. A 'Do-more' logo is displayed, followed by text about the 'Migrate DirectSOFT Project' utility. The bottom of the window contains a 'Tech Tips' section and a 'Product Support Forum' link.

If your computer is not connected to the Internet at the time of launching **DirectSOFT**, the DSLaunch window will display a message stating that the website is not available. This is okay. It isn't necessary to be on the Internet each time that DSLaunch is opened. Our website can be accessed anytime the computer is connected to the Internet by double-clicking **DirectSOFT** on the Web.

The main DSLaunch window is opened by selecting **DirectSOFT6 Programming** located in the **Applications** section of the Menu Tree. The launch window will then appear as follows.

From this window, additional utilities, such as, NetEdit, CTRIO WB, etc., can all be launched from one central location. This is also used to create and manage PLC programs and the communications links between your personal computer and the PLC.

Notice the different areas which are pointed out in the launch window.

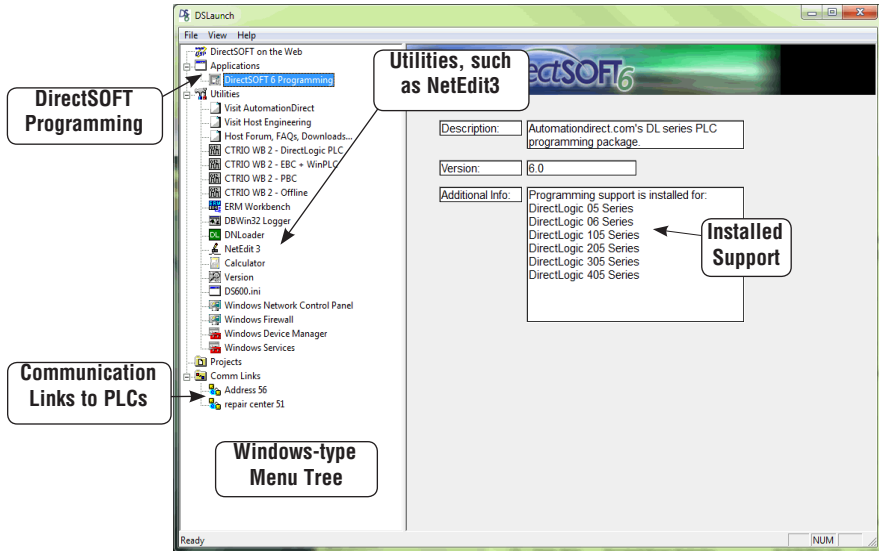

**NOTE:** Also see DSLAUNCH comments in Chapter 3.

If you have been using previous versions of *DirectSOFT* Programming Software, you will see that the DSLaunch window looks much like it has for many years. Descriptions of the various sections are as follows:

**Applications** — These are the applications currently installed in *DirectSOFT6*. They are visible in the Menu tree under the **Applications** folder/icon and are linked to applications that have been designed for launch from *DirectSOFT6*. For example, to create a new program, double-click the *DirectSOFT6 Programming* name.

**Utilities** — Several utilities are available under this folder/icon. If you have already installed available utilities, such as, NetEdit, CTRIO Workbench, etc., these will be shown here. Shortcuts to your favorite utilities can also be added by adding them to the Utilities section of the DS600.ini file.

**Projects** — These are the programs which are created in *DirectSOFT6*. A project is the collective name for your program and all of its documentation. When you create a new project or work on an existing project, you will see it listed in the Menu Tree under the **Projects** folder/icon by name. To open an existing project, double-click on the project name. To open a project not listed, right-click on Projects and select Browse to locate the project, then select it.

**Comm Links** — This is for the communication links used to connect from your PC to one or more of your PLCs. If there were Comm Links existing in your previous version of *DirectSOFT*, they will appear here. New Comm Links will also appear here after they are setup.

The remainder of this chapter will be devoted to the following:

1. Create a new program.
2. Add some rungs.
3. Document the elements and rungs.
4. Connect to a PLC.
5. Download to a PLC.
6. Monitor the program and change status.

## Welcome to *DirectSOFT100*



**NOTE:** If you have purchased the full version of *DirectSOFT6*, go to page 2-14, *Begin Editing a Program*.

If you have loaded the free version of *DirectSOFT6*, you should know what you can and cannot do with the software.

### What is *DirectSOFT100*?

The *DirectSOFT100* software is provided as a solution for small applications and to assist in your decision to purchase the full *DirectSOFT6* programming software. There are, of course, limitations to the use of *DirectSOFT100*. The following is what you can and cannot do with the software:

You **CAN** create a program from scratch, and it can be as large as you want it to be.

You **CAN** save programs larger than 100 words to disk, but you **CANNOT** write it to the PLC.

You **CAN** convert *DirectSOFT100* version to the full version if you purchase the key and enter the key code in the *DirectSOFT100* dialog (it may appear often) or in the **Help > About** dialog.

You **CANNOT** download a program to a PLC larger than 100 words.

You **CANNOT** open an offline project larger than 100 words.

You **CANNOT** open a program in the PLC larger than 100 words.

There are no other limitations. *DirectSOFT100* is able to use all of the features described in this manual. Many instances of *DirectSOFT100* can be running at one time and monitor any number of data points. *DirectSOFT100* is basically the same, functionally, as *DirectSOFT6* (full version) except the ladder program needs to remain within 100 words.



### Using *DirectSOFT100*?

To begin a project, double-click on **DirectSOFT6 Programming** under Applications on the menu tree. The following **Welcome to DirectSOFT100** window will appear.

Click on **Run DirectSOFT100** and the **New Project** dialog will open as shown on page 2-14.

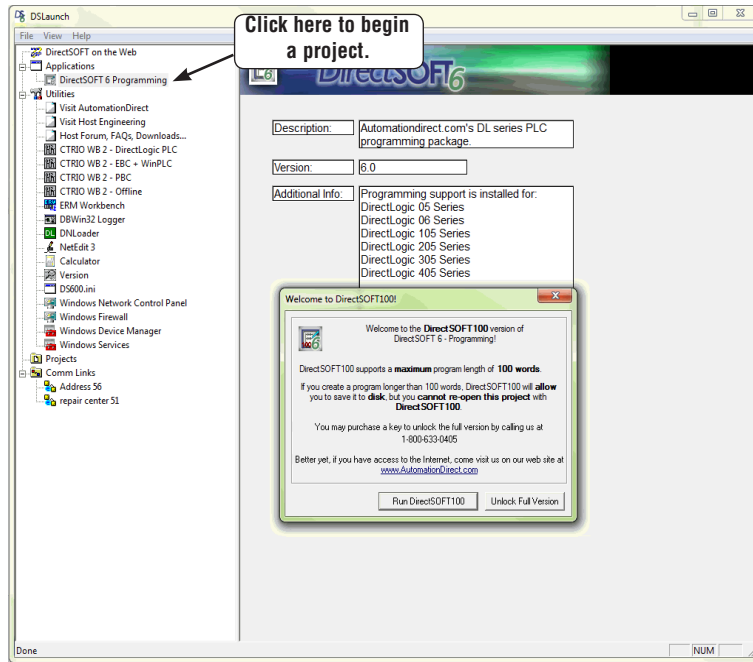

You can now begin to edit a program following from Step 1.

## Begin Editing a Program

You can now begin editing your program. The following steps will show you the basics of editing with *DirectSOFT6*. This will not be an attempt to teach you how to develop a control program, but it will give you the basics to get started using *DirectSOFT6* so that you can edit a program.

### Step 1: Start a New Project

To begin a new project, double-click *DirectSOFT6 Programming* under Applications in the menu tree. The following window will appear. The **New Project** window is used to enter the basic information to begin a new project. Name the new project, then move the cursor to the **Family** area and select the PLC family to match the PLC that you are using. Next, select the CPU type. Once all of the information has been entered, click on **OK**. Keep in mind that the available mnemonics, processing rules and the tool bar characteristics are tailored to the Family and Type selections that you make.

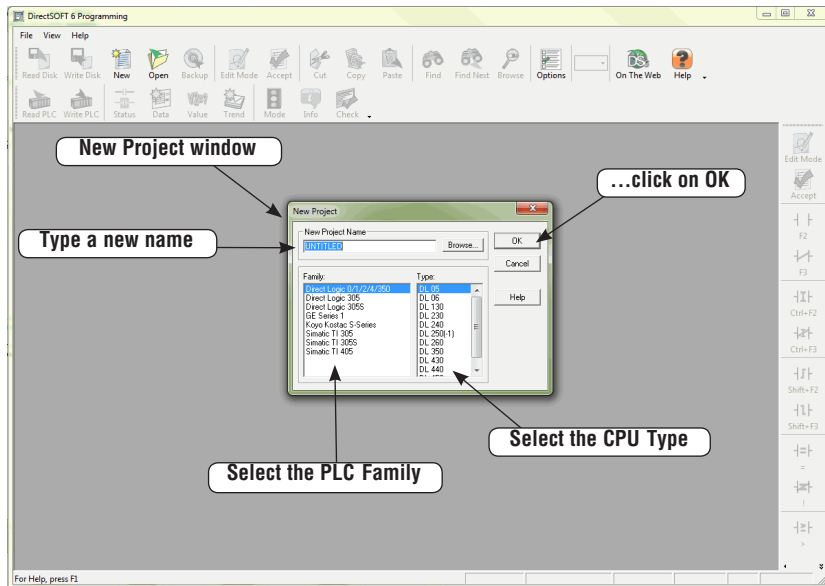



After clicking on **OK**, the next window to appear is the Ladder View with a Tip of the Day dialog box as seen below. The Tip of the Day dialog will appear each time a new project is started, and each time an existing project is opened. If it is not desired to have this dialog “pop-up” as mentioned, simply click off the check mark preceding “**Show tips at startup**”. The tips dialog can always be opened by clicking on **Help > Tip of the day** on the main menu bar. More tips can be read by clicking on the **Next** button. After clicking on the **Close** button the new Program display window will be totally in view.

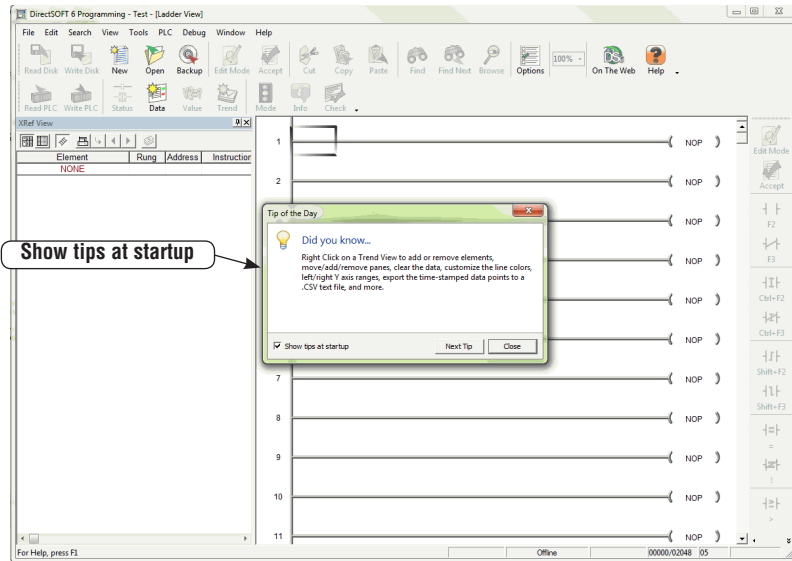

Regular users of *DirectSOFT* will note that the new programming window looks a bit different than previous *DirectSOFT* programming software. The “Online” and “Offline” toolbars have the same layout as previous *DirectSOFT* programming windows but a crisp new look for the button icons. Notice that some of the toolbar icons are grayed-out and some of the icons are not. The available icons in the online toolbar will be visible. As a program is edited, more of the grayed-out icons will become visible. The online toolbar is grayed-out and will remain this way until the PC is connected to the PLC. See Chapter 4 for more toolbar features.

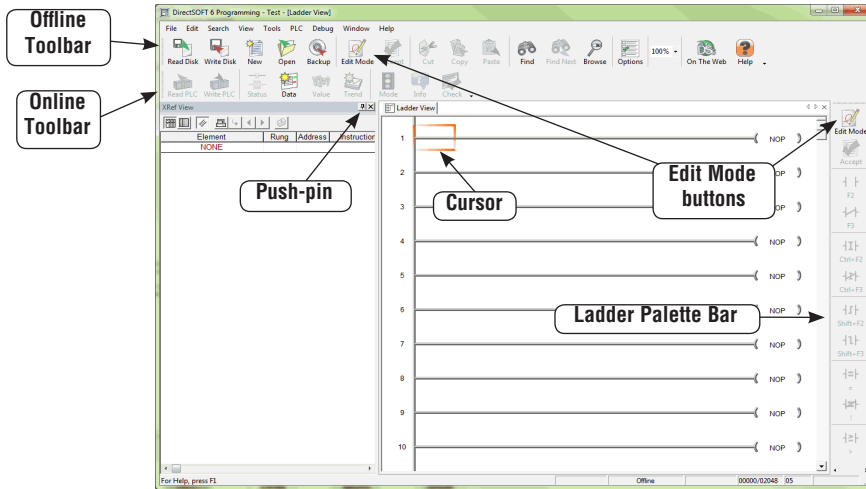

By default, there are two windows that will be in view when a new project is opened. One is the **Cross Reference View** on the left and the other is the **Ladder View** on the right. The Cross Reference View is one of the dockable views in *DirectSOFT6* which also includes Data Views and the Output window. These views can be docked to any edge of the Programming Window or they can be undocked and “float” to any part of the screen, even onto a different display if you have multiple monitors. If the view is docked, you can “auto-hide” the view by clicking on the push-pin in the upper right-hand corner of the view. The view will auto-hide to the left of the Ladder View with the name of the view on the tab. To bring the view from auto-hide, hold the mouse cursor over the name in the tab. If the view is not needed, click on the X located to the right of the push-pin to close the view. See Chapter 7 to learn more about views.

Notice the **Ladder Palette Bar** located to the right of the Ladder View. The element buttons are grayed-out unless the Edit Mode has been activated. To activate the Ladder Palette, click on either **EDIT Mode** button; one is located on the Offline toolbar and one is located at the top of the Ladder Palette. This palette can be repositioned anywhere on the screen by “grabbing” it with the mouse pointer at the top of the palette and dragging it to a new position. The Ladder Palette contains the buttons that access the rung elements and operations commonly used when editing ladder logic programs.

The diagram below shows a newly opened Display window with the Cross Reference View in the auto-hide position and the Ladder View in full view.

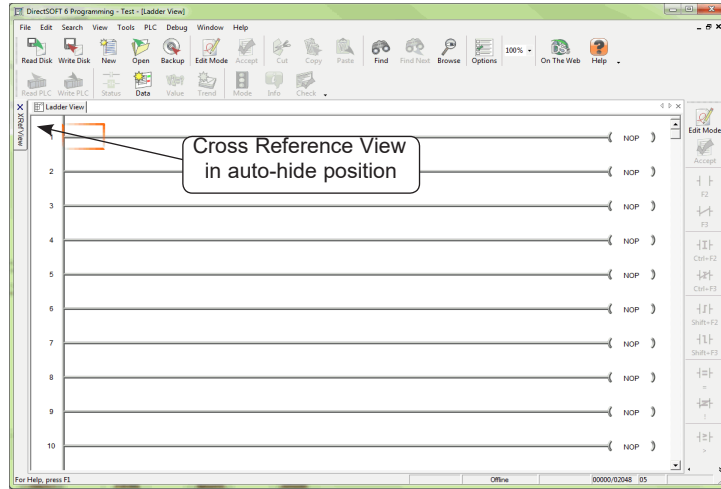

It is good practice to leave the Cross Reference View open while editing your program. The rung elements are added to the Cross Reference View as the program is accepted.

Accepting a program will be discussed later in this chapter.



**NOTE:** The Cross Reference View can be retrieved by going to View on the Menu Bar and select it from the drop-down menu, then click on the push-pin to keep it in view.

### Step 2: Select Edit Mode

The ladder View has two viewing modes; the **Display Mode** and the **Edit Mode**. When a new program or an existing program is opened, the Ladder View will be in the Display Mode which is only a viewing mode. A program cannot be edited in this mode. In order to edit a program, you must be in the Edit Mode. To enable the Edit Mode, either click on the Edit Mode button on the Offline toolbar or click on the Edit Mode button on the Ladder Palette Bar. You will know when the Edit Mode is active when the cursor box becomes solid, a box appears around the Edit Mode buttons and the elements in the Ladder Palette are highlighted (see diagram on the next page).

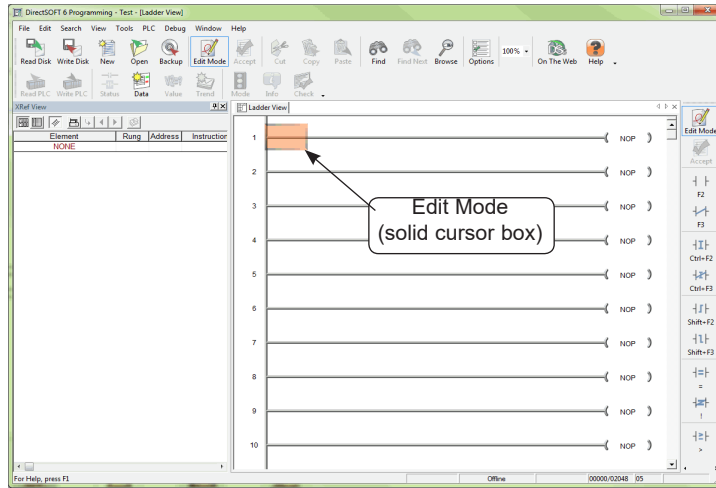

The Ladder Palette (shown below) may not be exactly like the one you have on your computer screen. The elements shown in the palette will depend on which CPU your PLC is using. This example shows the elements common to most of the CPUs.

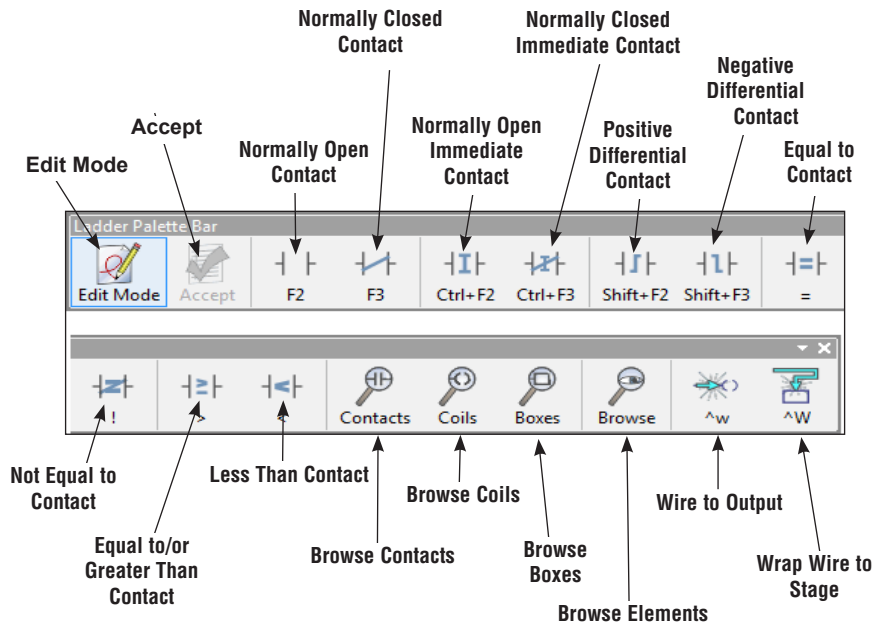

### Step 3: Enter an Input Element

Use the Ladder Palette to enter the first instruction of the program. First, click on one of the Edit Mode buttons to begin to edit your program. The rectangular edit cursor will change to a solid color. The edit cursor should be positioned to the far left on Rung 1. Your first entry can be placed here, normally a relay contact or an element. Click on the **Normally Open Contact** symbol on the palette.

The cursor will change to a box with an open relay contact, a window with the text cursor blinking at the end of address **C0** (highlighted) and green, valid entry, indicators.

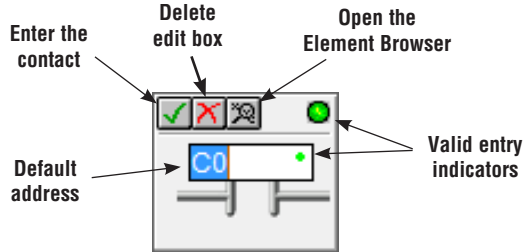

If the green dot changes to red, it means that the address is incorrect, not valid or a wrong character. For example, if you typed the letter “O” instead of the digit “0”, the indicator would turn red and stay red until you correct the mistake. For this example, enter **X0** over C0. The valid entry indicator should be green meaning the address is correct. Continue by either clicking on the check mark (✓) or pressing the **Enter** key.

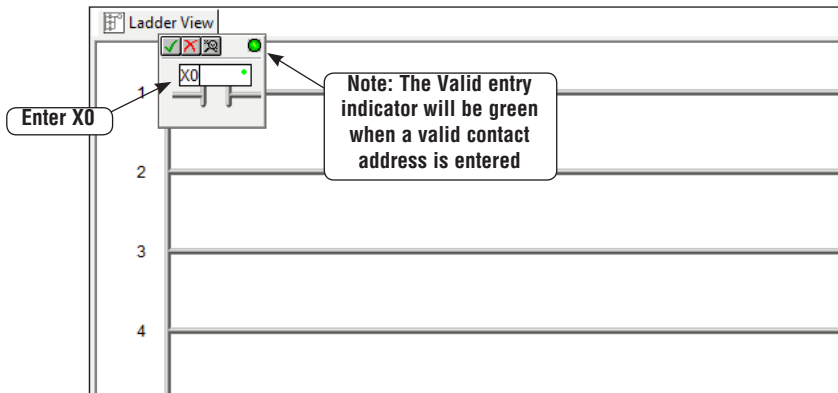

The element will be entered and the cursor will move to the next entry position. A yellow vertical bar will appear to the left of Rung 1. The yellow bar indicates that an instruction (or instructions) has been entered, but the program has not been accepted (compiled).

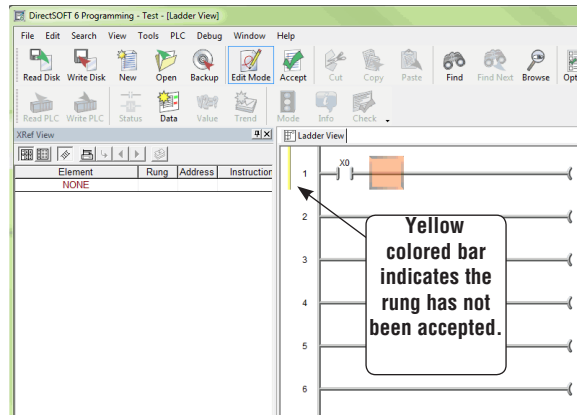

#### Step 4: Enter an Output Element

Now, move the cursor to the end of the rung, positioned over the **NOP**. Click on the **Browse Coils** button on the Ladder Palette. The **Instruction Browser** will appear with the **Standard Coil** selected as the default. Click **OK** to enter the standard coil. Keep in mind that one of the other output coils could have been selected.

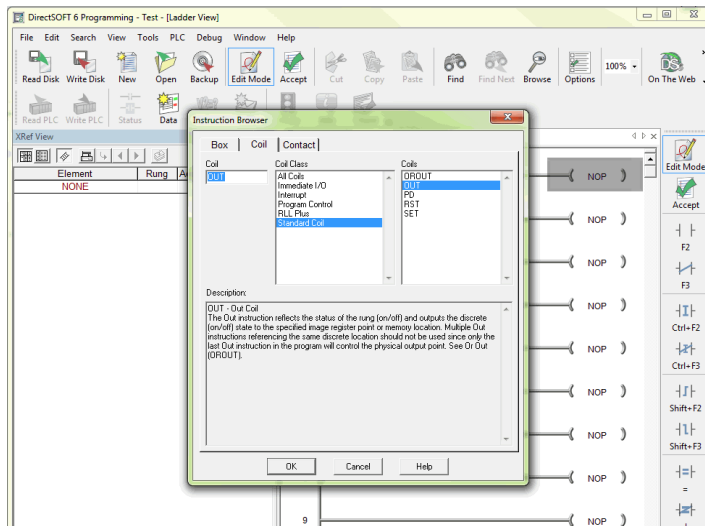

The Instruction Browser will be replaced with the element entry box. The default address, C0, will be highlighted. Enter **Y0** and notice the valid entry indicator is green for a proper entry. Either click on the (✓) or press the **Enter** key to enter the output coil.

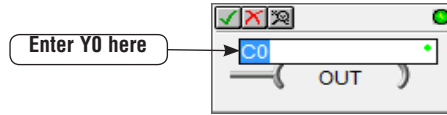

Rung 1 has now been programmed. This rung can be downloaded to the PLC except for one missing rung. All programs must be terminated with an **END Coil** rung.

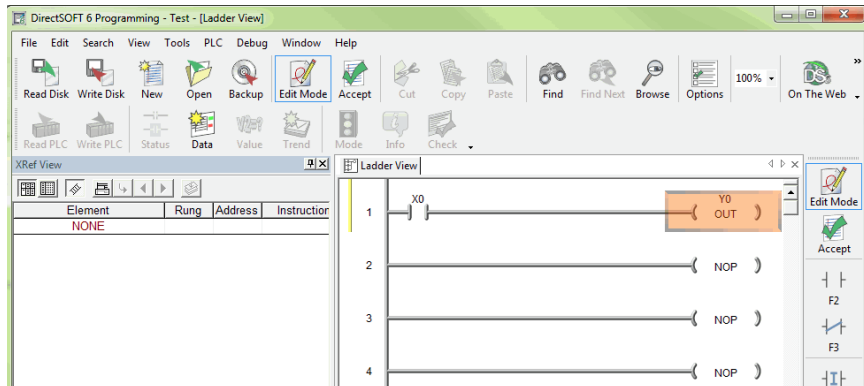

### Step 5: Enter the End Rung

To program this rung, position the cursor over the **NOP** at the end of Rung 2, and click on the Browse Coils button. The Instruction Browser will appear as shown in the diagram below. This time, select **Program Control** located in the **Coil Class** selection window. Next, select **END** located in the **Coils** selection window. Click on **OK**, then **Enter**.

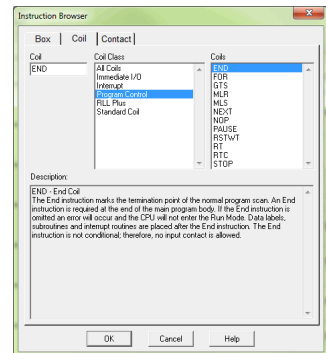

The below diagram shows the two rungs that have been programmed. This is a basic program that can be downloaded to your PLC. Additional rungs can be programmed, but you can go ahead and accept the program.

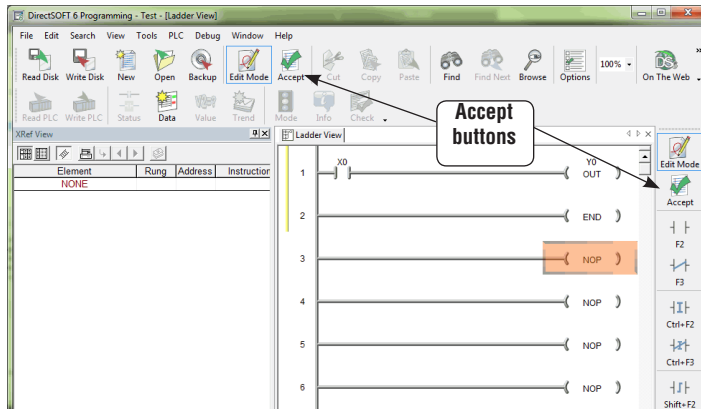

### Step 6: Accepting and Saving the Program

The program now needs to be accepted in order to be downloaded to the PLC. As noted in the above diagram, there are two **Accept** buttons. Click on either **Accept** button to compile the program. Once the rungs are accepted with no errors, the yellow bar will change to green, the Accept buttons will be grayed-out and the Cross Reference View now shows the two elements that have been programmed.

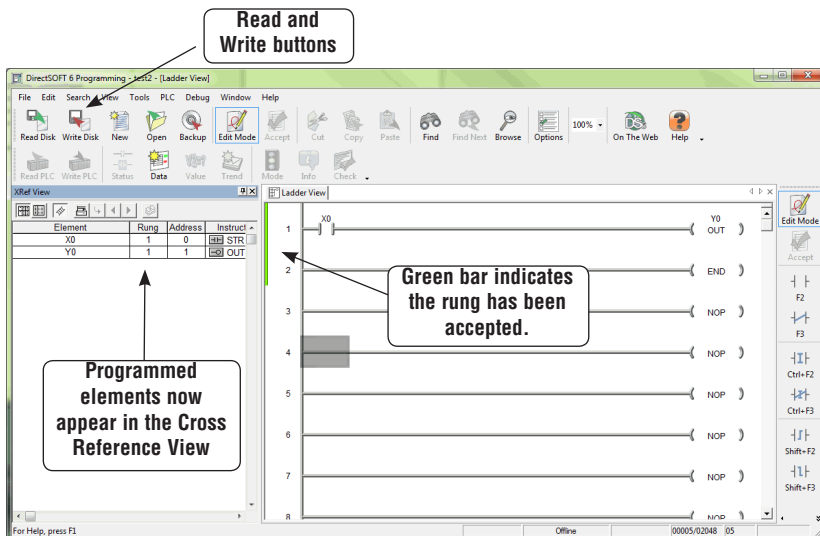



Notice that the two Read and Write buttons located to the left of the Offline toolbar are enabled and no longer grayed-out. The program can now be saved to the PC's disk. To write the program to disk, click on the Write button. It is not necessary to save the program in order to download the program to the PLC, however, it is good practice to save your work as you edit a program. A mistake may be made at times and you may want to restore the program to a previous state prior to the mistake. If a mistake is made and you want to restore the program, click on the Read button. This will refresh the screen with the previously saved version of your program.



---

**NOTE:** When the program is saved by clicking on Write (only to disk), the ladder program is all that is saved. Once you have edited a program and have included total documentation, you will want to save all that you have done. This is accomplished by selecting File > Save Project > to disk. You can also click on Backup to accomplish the same thing with the addition of a Backup file. For more detail about documenting and saving the project refer to Chapter 6.

---

## Establish the Communication Link

In order to download a program to the PLC a communication link must be established. This section will step you through the procedure for setting up the serial port of your PC. Refer to Chapter 9 if you need to create a serial link for a modem, or an Ethernet link. The following procedure will step you through the process of connecting the example program to a PLC.

### Connect the PC to the PLC

Connect the programming cable from the serial port of the PC to the serial port of the PLC. Turn on your PLC and be sure that the **RUN/TERM/STOP** switch on the PLC is in the **TERM** position. Now, click on **PLC** on the Menu Bar, then select **Connect** from the drop-down menu and the **Select Link** dialog will appear. Since there isn't a link to chose, click on **Add**.

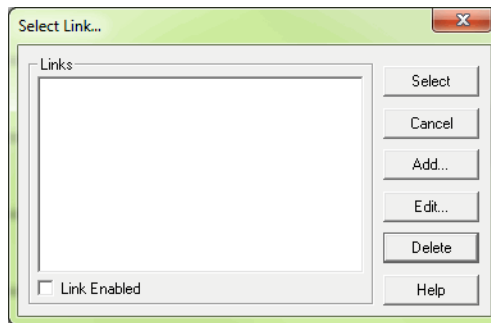

### Step 1: Select the Port

The following Link Wizard dialog will appear showing a list of communication ports. Select the port you will use (commonly COM1) and click **Next**.

*DirectSOFT6* will automatically find any communications ports that are shown in the Windows Device Manager. If a port is not shown please close all *DirectSOFT6* windows and restart the program.

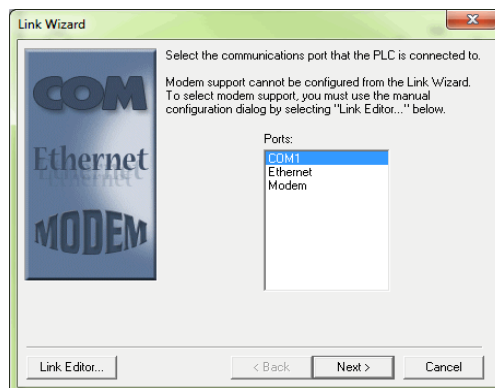

### Step 2: Select the PLC

The next window will show a list of **PLC Families**. Select the PLC family by clicking on the appropriate choice. If you are unsure of the PLC family but know which communications protocol to use, select “**Not Sure**”. If you are using a *Direct*LOGIC compatible PLC, the Link Wizard will try and detect the PLC type automatically. Click **Next** when you are finished.

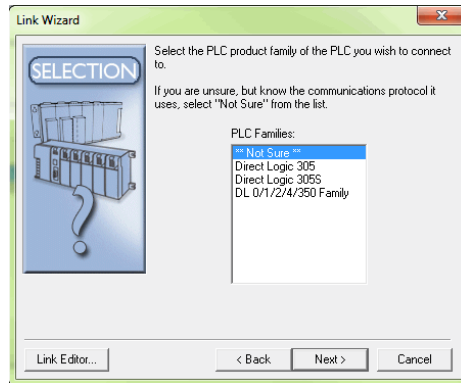

**NOTE:** DL 0/1/2/4/350 should be selected for the following PLC families: DL05, DL06, DL105, DL205, D3-350 and DL405.

### Step 3: Choose the Protocol and Node Address

In this step, you will see a choice of either *Direct*NET or **K-Sequence**. Assuming you have selected the *Direct*LOGIC PLC family (not the DL305), the default, K-Sequence, will be highlighted. The K-Sequence protocol allows you to perform write operations to individual discrete I/O points and control relays. *Direct*NET protocol cannot write to individual bit locations. (See Appendix A for a list of protocols available for *Direct*LOGIC and compatible PLCs).

If your PLC has been configured with a node address other than 1, enter that address now. Click **Next** when finished.

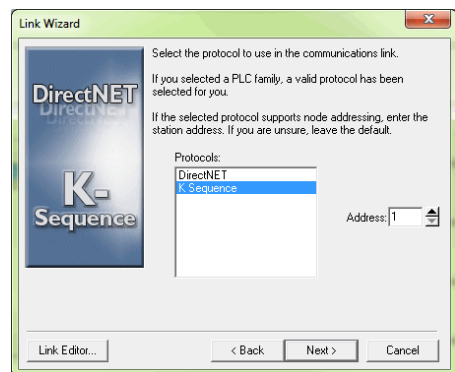

## Step 4: Name the Link

If the Link Wizard is successful in communicating with the PLC, the following window will prompt you to enter a unique link name, and a description of the link if desired. The description field allows 32 characters. Enter the name for the link and description then click **Finish** and the Select Link dialog will appear with the link name listed.

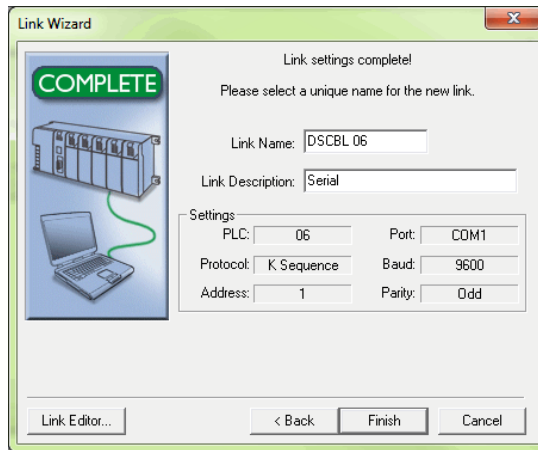

Since the link that was just created is the only one named in the dialog, click on **Select** to initiate connecting to the PLC.

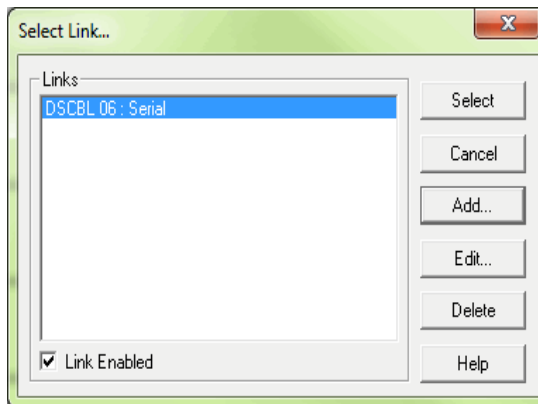

*Direct*SOFT6 automatically compares the currently open program with the program stored in the PLC. The following **Online/Offline Differences** dialog box will appear. This dialog asks which copy of the ladder logic program is to be viewed, the copy in the PLC or the copy on

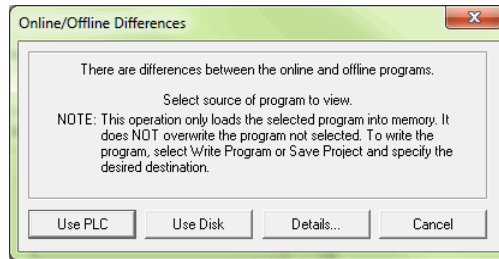

the PC. Since we are dealing with a new program, select the **Use Disk** button. The Use Disk button is used whenever you have made a change to a program in the PC, and you are going online to load it into the PLC. If the **Details** button is pressed, a side-by-side comparison of the program in the PLC and the program on the PC will appear, such as the **Compare Programs** dialog seen below. The program selection can also be made from this dialog.

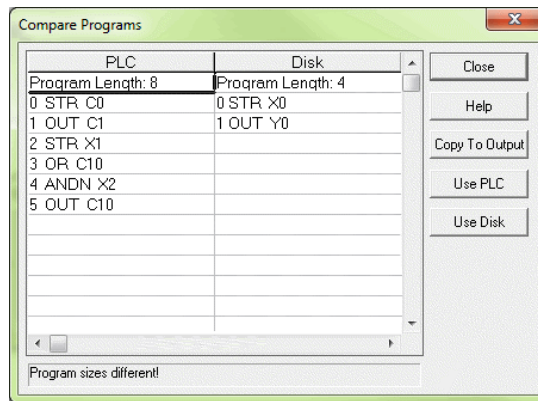

After clicking on the Use Disk button, the programming window will look a bit different. Notice that the icon buttons in the **Online Toolbar** are no longer grayed-out. The indicators at the bottom of the window tell you that the PLC is okay, the PC is online with the PLC and the PLC is in Program Mode. *At this point the program has not been written to the PLC.* You will also notice the two left most buttons on the Online toolbar (**Read PLC** and **Write PLC**) are highlighted. To write the program to the PLC, select Write PLC. A pop-up indicator will appear to let you know that the program is being written to the PLC.

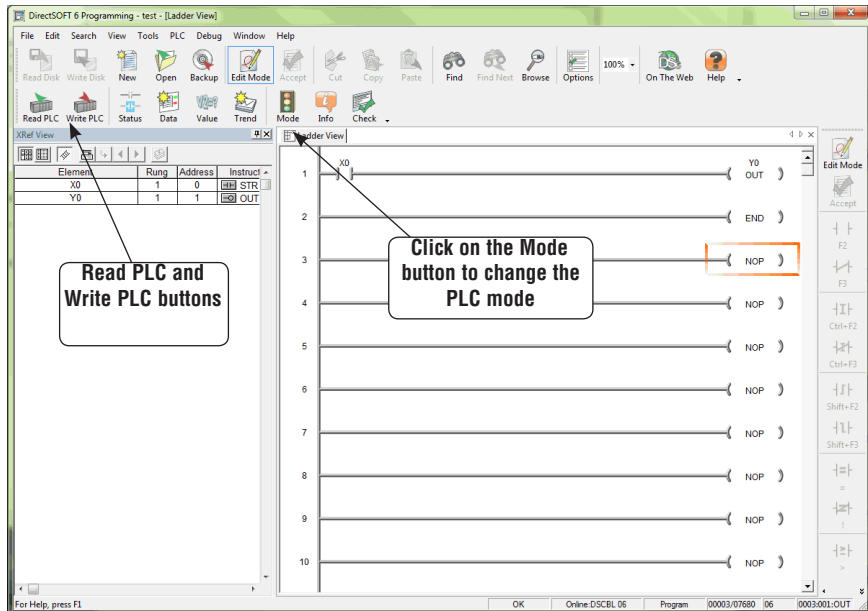

After the program has been written to the PLC, all that needs to be done is to place the PLC in the RUN Mode. Click on the **Mode** button on the Online toolbar. This will bring the **PLC Modes** dialog window into view. Click on **Run**, then **OK** and the PLC will be in the RUN Mode.

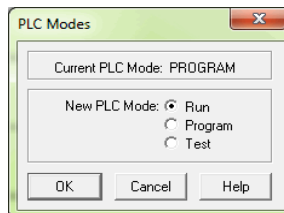

Notice the green indicator at the bottom of the Ladder View. It shows the PLC is now in the Run Mode. How do you know that your program works? The best way is to monitor the program while the PLC is online.

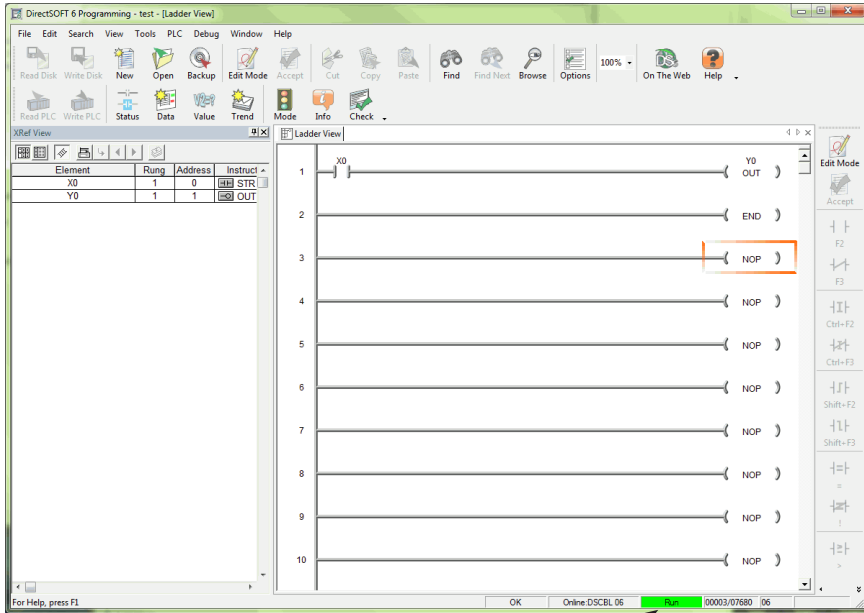

Green indicating  
Run Mode

## Monitor the Program

There are many things that can be monitored in the relay ladder program by simply clicking on the **Status** button on the online toolbar. The monitor mode can be turned On and Off by clicking on the status button. When in the status mode, the element background will change to blue (by default) to indicate power flow when the input element is turned on. If there is power flow, the output background will also change color.

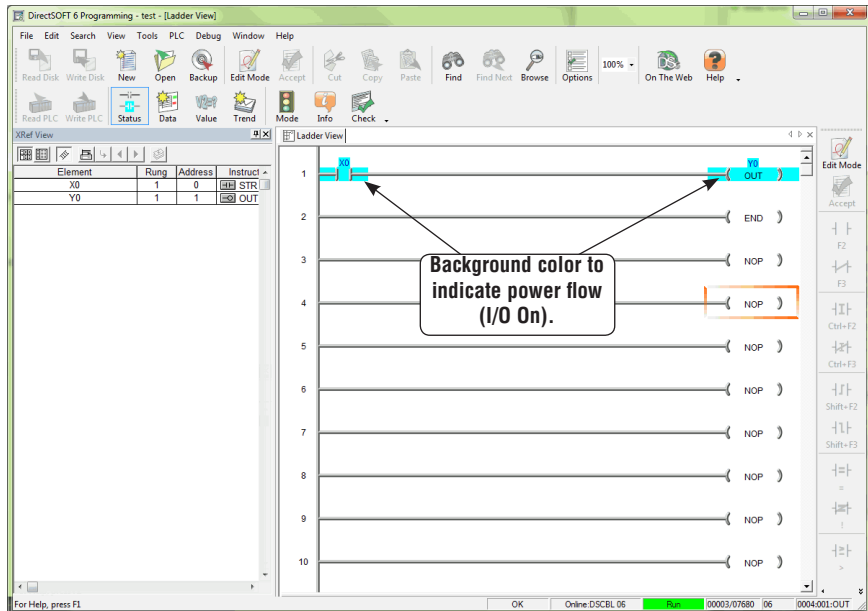

The program editing and testing is now complete. The example program is the most simple program that can be written. You can add to this program by inserting rungs before the END rung (Rung 2) or by deleting the END rung and continuing to edit additional rungs. Do not forget to end your program with an END rung.



The following graphic is an example of how you might continue with your program. Note the Cross Reference View and the Data View panels on the left. Chapters 9 and 10 will explain how to use these views.

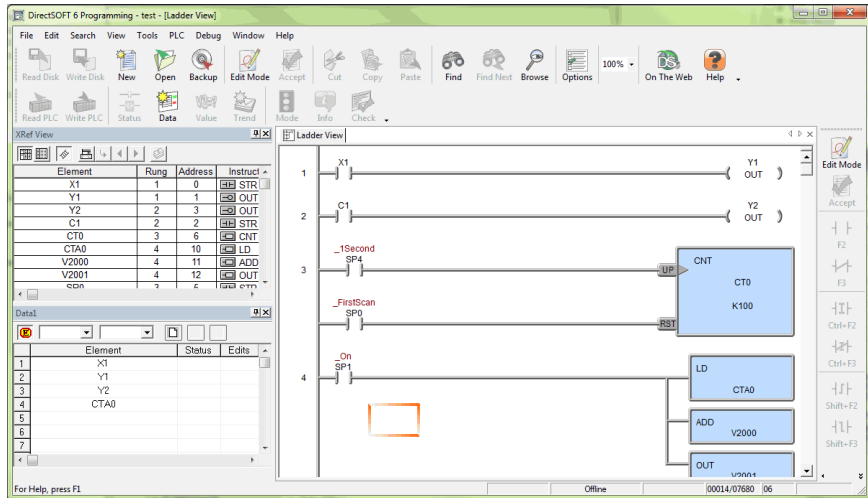

# MANAGING PROJECTS

---



## In This Chapter...

Get Started Using <i>DirectSOFT6</i> .....	3-2
Create a New Project.....	3-4
Importing Projects.....	3-5
Copy or Save Existing <i>DirectSOFT</i> Files .....	3-7

## Get Started Using *DirectSOFT6*

To open *DirectSOFT6*, double-click on the *DirectSOFT6* icon which was installed on your desktop during the installation of the software. You can also click on Start located in the left-hand corner of the computer monitor. Once you do this, select Programs, find *DirectSOFT6*, then select DSLaunch6 in the drop-down window. The DSLaunch window, shown below, will appear. The DSLaunch window displays all of the applications and PLCs that *DirectSOFT6* supports.



### Understanding the Launch Window

*DirectSOFT6* Programming Software is much more than a PLC programming package. With the Launch Window concept, utilities, such as, NetEdit, CTRLIO WB, etc., can all be launched from one central location. The Launch Window is also used to create and manage PLC projects and the communication links between your personal computer and the PLC.

Notice the different areas in the Launch Window. There is a menu tree very similar to what is in Windows Explorer. All that you see in the menu tree can be accessed from the tree.

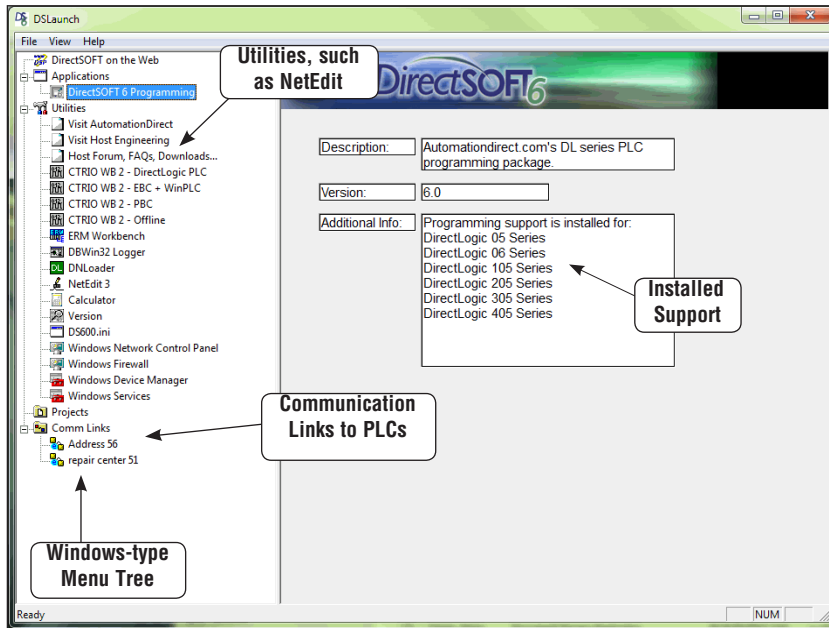

The menu tree has four folder/icons which are:

- **Applications** - These are the applications currently installed in *DirectSOFT6*. The only installed application available is *DirectSOFT6* Programming. This is the point where you start a new project.
- **Utilities** - Several utilities are installed here such as, ERM Workbench, CTRIO Workbench and NetEdit. They are installed automatically when *DirectSOFT6* is installed.
- **Projects** - This folder/icon will contain the projects which are created in *DirectSOFT6*. A project is the collective name for your ladder logic program and all of the documentation associated with it. Newly created projects and existing projects will reside here. As projects are created, they are added to the end of the list.
- **Comm Links** - This folder/icon will contain the communication links between the personal computer and the different PLCs that you have (See Chapter 9).

# Create a New Project

## New Program

To create a new program, double-click on **DirectSOFT6 Programming** in the **Applications** folder on the DSLaunch menu tree.

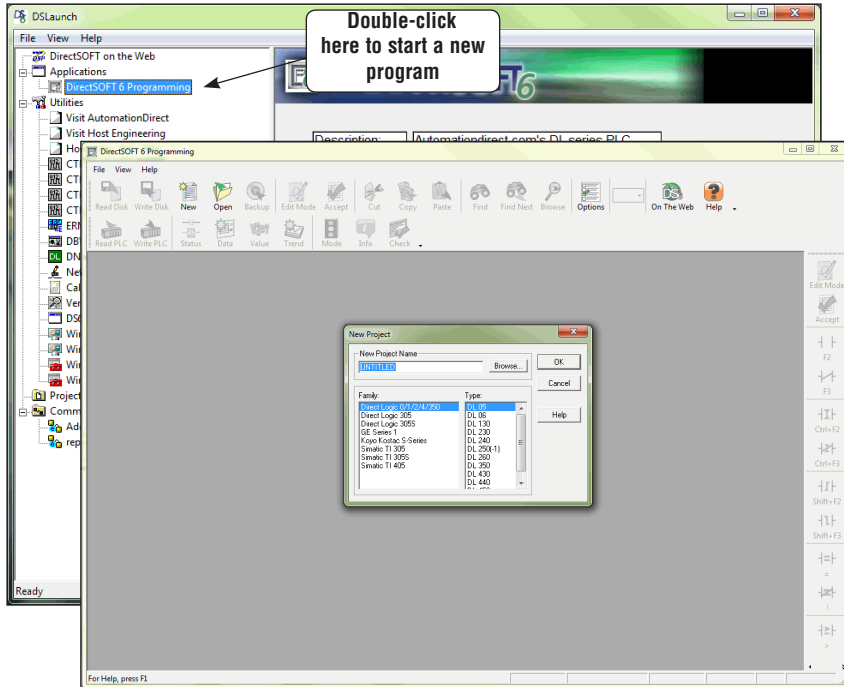

## Enter the New Project Information

The New Project dialog box is used to define several things.

- **New Project Name** — enter a name for your project (up to 32 characters - no extension).
- **Family** — select the *Direct*LOGIC PLC family (or compatible) you will be using.
- **Type** — select the CPU you are using from the available list. Remember, different PLCs use similar instructions, but they are still different in some ways. For this reason, it is extremely important that you specify the correct CPU.
- **Browse** — you can keep the default project path, `c:\DirectSOFT6\projects`, or use the Browse button to either select a project not shown on the menu tree or a different folder with the project listed in it.

## Importing Projects

You may already have TISOFT or Logicmaster programs stored on your PC's hard drive or on a disk. You may also have projects that were exported from an older version of *DirectSOFT*. Use the following procedure to import these programs.

1. Open the New Project dialog as described on the previous page.
2. When the New Project dialog appears, click on the **Cancel** button. The programming window will remain on the screen.
3. Click on **File** on the toolbar, then select **Import > Program**. The **Import Program** dialog will appear as shown below.
4. Locate the program to be imported by selecting **Look in:**, then the location of the program.

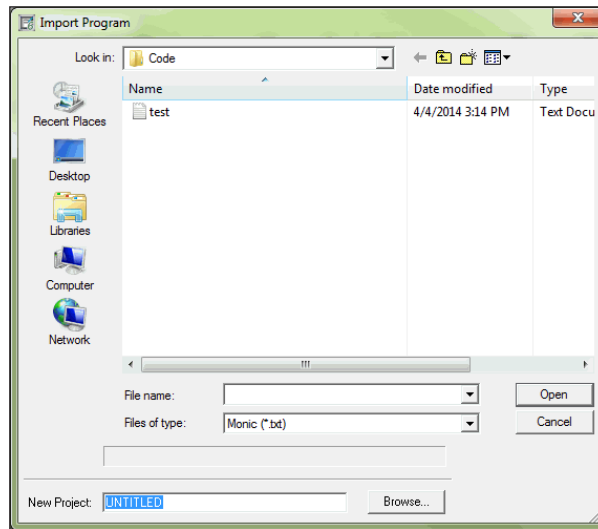

5. Select the **Files of type:** to choose the correct file, such as, Tlsoft (\*.vpu).
6. Select the program file name to be imported (up to 32 characters with no extension) from the location where the program is found. The file name should appear in **File name:** area.
7. Either enter a name for the project in the **New Project:** area or use the Browse button to select the name of a location to store the project.
8. Click on the **Open** button to start the import process. An indicator window will appear to let you know that the program is being imported. After the program has been imported, it will appear as a normal *DirectSOFT6* program.

### Program Documentation Mapping from TISOFT and Logicmaster

Although most of the documentation will have a counterpart in *DirectSOFT6* some of the documentation will not. The following table shows what is imported, what is not and the *DirectSOFT6* counterparts.

<b>TISOFT Source Documentation</b>	<b><i>DirectSOFT6</i> Documentation</b>
Title Page	Title Page Editor
Synonyms	Element Description
Comments (tied to output coil)	Rung Comments (tied to rung)
Descriptions	No Match

<b>Logicmaster Source Documentation</b>	<b><i>DirectSOFT6</i> Documentation</b>
Nicknames	Nicknames
Names	Description
Comments	Comments
Coil Labels	No Match

## Copy or Save Existing *DirectSOFT* Files

The question often arises as to what is needed when copying existing *DirectSOFT* files to a different memory area or directory. If you are a first time user of *DirectSOFT6* and have no existing files to transfer, then you may skip this page and read it later.

By default, projects are stored originally in the **Projects** subdirectory, however, they can reside in areas other than the default projects subdirectory. It really does not matter where they are stored. The method for copying or saving these existing files to another area is the same in each case.

If you look where the projects have been stored, you will notice the main file for the project will always have a **.prj** extension after its root filename, but there are other files with the same root filename. This can be a little confusing to new users. This is due to the fact that *DirectSOFT6* performs a filename creation behind the scenes. Your only involvement with the initial storage is to indicate the root filename and directory path.

A frequently asked question is “which of these files do I need when making the storage transfer?”. Copying or saving the **filename.prj** will be insufficient to truly transfer the total project. Not all of the files are necessary to recreate the program, but if you eliminate any of them, you may lose some important documentation and indexing information. The table shown on the following page lists the different file extensions and what they contain. The safest choice is to save or copy all files for a project having the same root filename, regardless of the different file extensions (see the table on the next page).



<b>DirectSOFT6 Project Files</b>	
<b>File Extension</b>	<b>Contents</b>
dataviewname.dta	Data views are not associated with one single project, but can be shared among multiple projects
filename.dv	DV1000 setup
filename.esd	Element documentation (nickname, wiring information, description)
filename.esx	Index file for the element documentation
filename.inf	Project information
filename.lcd	Ladder rung comments
filename.lcx	Index file for the ladder rung comments
filename.lda	Connects rung comments to correct rung no.
filename.ldo	Online only: connects to correct rung number (temporary until saved offline to *.lda)
filename.pid	PID documentation
filename.prj	Contains the ladder program
filename.prt	Print settings
filename.rd	305 R-memory data
filename.rf	305 R-memory editor format
filename.scd	Stage comments
filename.scx	Index file for stage comments
filename.tls	PLC parameters, I/O configuration, pause bits
filename.vd	V-memory data
filename.vf	V-memory editor format
filename.wsp	Position of program windows, colors, etc.
filename.xml	Docking pane layouts

<b>Files Associated with DirectSOFT6 Project Files</b>	
<b>File Extension</b>	<b>Contents</b>
importexportDocumentationfilename.csv	Documentation CSV filename
ctrioworkbenchname.cwb	Counter I/O configuration
ermworkbenchname.erm	Ethernet remote master configuration
importexportmnemonicname.txt	Text file of Mnemonic version of ladder program.

# PROGRAMMING ENVIRONMENT

---



## In This Chapter...

Offline Toolbar Components.....	4-2
Online Toolbar Components.....	4-5
Additional Toolbars .....	4-6
The Options Dialog .....	4-21
Colors in <i>DirectSOFT6</i> .....	4-24
The Ladder Palette .....	4-28
The Split Screen Feature .....	4-30
The New Window Feature.....	4-31

# Offline Toolbar Components

Once the Program Window has been opened, the Online and Offline toolbars are in view. The diagram below shows the default location of the Online and Offline Toolbars whenever a new program is started. The grayed-out icon buttons become highlighted as the program is being edited. Along with the toolbar icon buttons, the button functions are also available from the menu bar located at the top of the program window. The grayed-out Online toolbar will become available once the PC is online with the PLC.

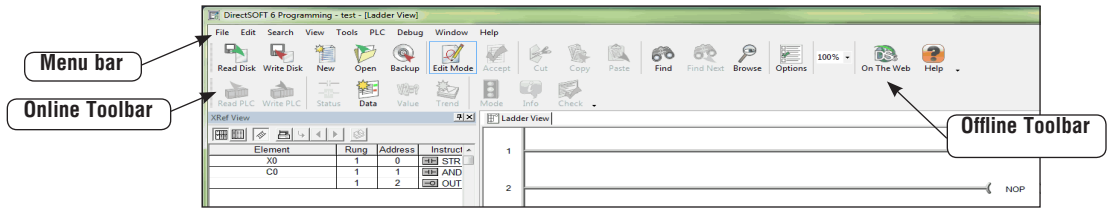

The toolbars are movable, or floating. By selecting the toolbar and dragging it with the mouse, the toolbar can be located wherever the programmer wishes to place it on the desktop.

## Offline Toolbar

### Read from Disk



This button is used to retrieve and open a program from the disk. The program will appear in the Ladder View.

### Write to Disk



The ladder logic program will be saved to the .prj project file on disk (not the entire project). It is a good practice to save your work frequently. This helps prevent data losses in the event of a system problem, such as a power failure.

### New Offline Project



This button will begin a new project offline. This button can be used with a project already open. The project will not be overwritten with the new project. You will be prompted to save the project before a new Ladder View will appear. An Offline Project includes the program, as well as other types of data, like V-Memory and documentation.

### Open a Project



This will open an existing project. A project can be opened when an existing project is already open. You will first be prompted to save your project, then the project that has been selected will be opened.

### Backup to File



Click on this button to make a backup copy of your project.

### Edit a Program



This button will turn on the Edit Mode. When the ladder view is in Edit Mode, the edit cursor will be a solid block on the screen. Click the Edit Mode button again to toggle back to Display Mode.

### Accept the Program



Before the edited program can be downloaded to the PLC, the Accept button must be pressed. Once this is done, the program will be compiled; in other words, the program is put into a form that can be downloaded to the PLC.

### Cut



This button is available in the Edit Mode. It allows the programmer to delete a marked, or selected, rung or rungs from the program and place it on the clipboard.

### Copy



This button allows the programmer to copy one or more marked, or selected, program rungs to the clipboard (see page 5-21).

### Paste



Whenever rungs are cut or copied, they are stored on a clipboard. Position the cursor where you want the rungs to go, then use this button to paste the rungs currently on the clipboard to the new location.

### Find



This button is used to locate an element within a program. The element can be selected with the cursor before using the button or click on the button and enter the element to be found.

### Next



Using this button will find the next occurrence of the element specified when the Find button has been used.

### Browse for an Element



This button provides a quick overview of valid element ranges and nicknames for the current content as well as a convenient way to document an element.

### Display the Options Dialog



Using this button will display the Options Dialog which will allow the programmer to set up the different views available to the programmer.

### **Zoom**



This selection is used to either increase or decrease the size of the current program view. Click the arrow to select the desired size from the drop-down menu.

### **DS on the Web**



This button will open the DirectSOFT on the web window.

### **Help**



This button will open the Help menu window.

## Online Toolbar Components

The following button icons are available after *DirectSOFT* is connected and online with the PLC.

### Online Toolbar

#### Read the Program From PLC



This button will read the program from the online PLC.

#### Write the Program to PLC



This button will write the program to the online PLC.

#### Program Status



This button will turn on the status display for the current view.

#### New Data View



Using this button will open a Data View window (see Chapter 10).

#### Change Value



This button will open the Change Value window to allow the programmer to change element status, values, etc..

#### New Trend View



This button will open a Trend View window (see Chapter 10).

#### PLC Mode



This button opens the Mode window to display the current mode of the PLC and to allow the Mode of the PLC to be changed. Choices are Run, Program and Test.

#### System Information



Use this button to open a window with the version, status and error information about the PLC.

#### Syntax



This button will run a Syntax check of the PLC and a Duplicate I/O check.

### Additional Toolbars

In addition to the default Offline and Online toolbars, other toolbars can be activated and used if desired. To view additional toolbars click on **View > Toolbars** and select the toolbar or toolbars that would assist you with editing your program. The Toolbar selection window lists fourteen toolbars and a Customize option. The three toolbars at the top of the list are checked since they are the default toolbars. The rest of the toolbars are optional, and they can be selected if desired. Note the down arrow at the end of each toolbar. This down arrow allows the programmer to customize the toolbar by adding or removing buttons.

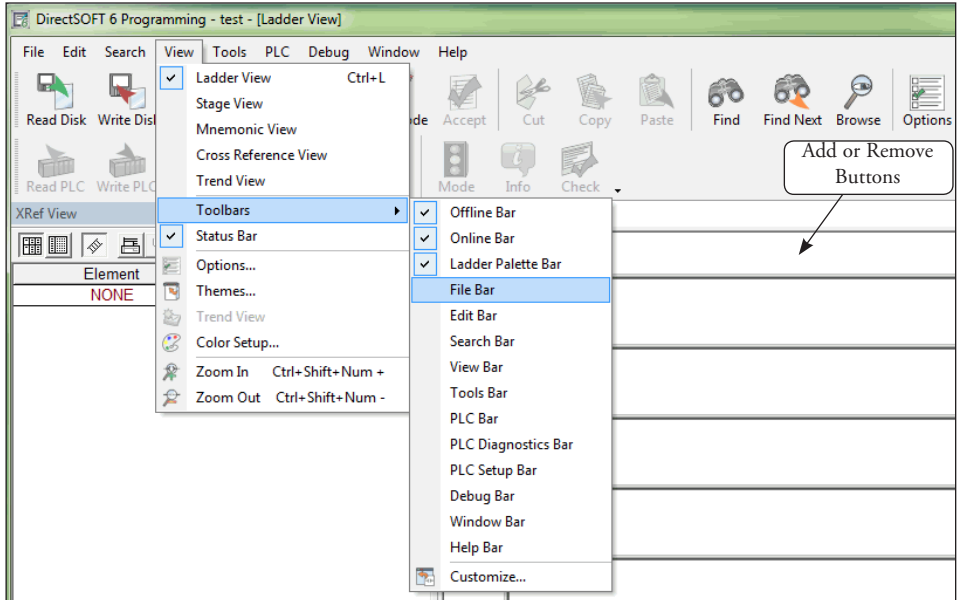

After selecting the file toolbar, it will be added to the Ladder View window beneath the Online toolbar as shown in the diagram below. This toolbar can be moved to any location of the programmer's preference by dragging it with the mouse arrow.

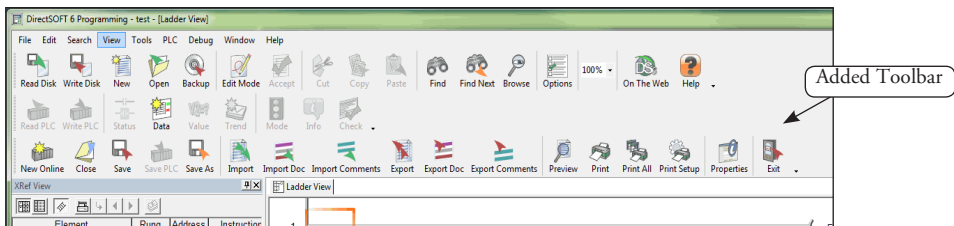

## The File Toolbar

The File Toolbar duplicates the more commonly used commands from the main menu File. Notice that the icon buttons are in groups, divided by a gray vertical line.

### New Online Project

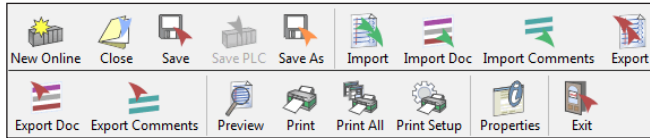

Create a new project that is linked to the PLC.

### Close Project

This button will close the current project. A message window will pop-up if the program has not been saved. The program can then be saved.

### Save Project to Disk

This button will save the entire project to disk, and will also create a new auto-backup version of the project.

### Save Project to PLC

Use this button to save the entire project to the PLC.

### Save As to Disk

Use this button to save the active project to a different disk file.

### Import

This button will allow the programmer to import a project from a non-*Direct*SOFT6 format.

### Import Element Documentation

This button allows the programmer to import a document containing nicknames, wiring information and descriptions from comma separated variable (.csv) text format.

### Import Rung Comments

This button will allow the importation of rung comments in text form.

### Export

This button is used to export a project to a non-*Direct*SOFT6 format (see Chapter 6).



### Export Element Documentation

This button allows the programmer to export element documentation containing nicknames, wiring information and descriptions in the current *DirectSOFT6* project to a text file in comma separated variable text format.

### Export Rung Comments

This button will allow the programmer to export the active ladder logic rung comments in text form.

### Preview the Program

Use this button to display the current view as it would appear in printed format. Once previewed, the program can be printed.

### Print

This will allow the printing of the current view and selected documents.

### Print All

Use this button to allow the programmer to print all of the documents that are selected.

### Setup

This button will open the printer setup dialog.

### Properties

This button will show the project properties.

### Exit

This button will allow the programmer to exit the project. If the project has not been saved, a pop-up window will remind the programmer to save the project, otherwise, the project will close.

## The Edit Toolbar

The Edit Toolbar is only active in the Edit Mode. It duplicates some of the main menu Edit commands.

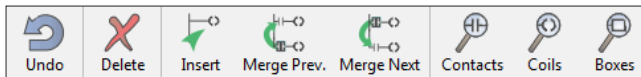

### Undo

Use this button to undo the changes to the current rung that has been edited and not yet compiled. The edit cursor must be on the rung to be restored when the undo button is clicked on.

### Delete

The Delete button will delete the element under the edit cursor. If there is no element under the cursor to be deleted, a pop-up message asks if the rung is to be deleted. If multiple rungs are selected (highlighted), it will delete these rungs (See Chapter 5).

### Insert

This button will allow rows and columns to be inserted in a rung.

### Merge the Previous Rung

This button will merge the previous rung with the current rung.

### Merge the Next Rung

Use this button to merge the next rung with the current rung.

### Browse Contact

This button will open the Instruction Browser window ready for a contact to be selected.

### Browse Coil

This button opens the Instruction Browser window ready for the selection of a coil.

### Browse Boxes

Use this button to open the Instruction Browser with the box instructions available for selection.

## The Search Toolbar

The Search Toolbar only contains two command buttons, **Replace** and **GoTo**.



### Replace

This button will activate the replace dialog so the programmer can search for an object in the program, or a range of elements and replace them.

### GoTo

This button activates a Goto dialog so the programmer can enter a rung number or address he wishes to view. Pressing OK will display the cursor on the desired rung/address.

### The View Toolbar

The View Toolbar has five buttons that can alter the appearance of the software.



#### Customize

This button allows the programmer to display or hide the various Toolbars, to modify the commands that appear on each Toolbar, or to create your own Custom Toolbars.

#### Themes

Use this button to select from a variety of User Interface Themes that will give *DirectSOFT6* a new look and feel. You can choose themes, such as, the Office XP theme, the Office 2003 theme, the Mac theme, etc.

#### Colors

Use this button to activate a Color Setup dialog so the programmer can select different colors for various items in *DirectSOFT6*, such as, the background for the Ladder View.

#### Zoom In

This button will increase the size of the current program view.

#### Zoom Out

This button will decrease the size of the current program view.

## The Tools Toolbar

The Tools toolbar duplicates the Tools menu from the main menu. These buttons can be a valuable asset to the programmer.

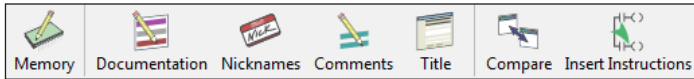

### Memory Editor

This button will open the Memory Editor dialog which will allow the programmer to edit data in V-memory (or R-memory in 305 / 305S PLCs).

### Documentation Editor

This button opens the Documentation Editor view to be used to define Nicknames, Wiring Information and Descriptions for the elements which are used in the program.

### Assign Nicknames

*Direct*SOFT6 allows the programmer to create an entire program with Nicknames without first assigning them to the actual elements (addresses) a.k.a. Symbolic Programming. When the program is ready to be written to the PLC, pressing the Nicknames button opens the Assign Nicknames dialog where the programmer can assign actual elements (addresses) to the unassigned Nicknames used in the program.

### Comment

This button activates the Edit Comments dialog where the programmer can create or modify the comment for the current rung in the Ladder View, or the current stage in the Stage View.

### Title

Use this button to allow the programmer to Edit the title for the project.

### Compare

This button provides a window so the programmer can compare the current program with another program on disk or with the program in the PLC.

### Insert Instructions

This button is used to insert instructions from a Mnemonic text file into the current program, optionally including element documentation.

### The PLC Toolbar

The PLC toolbar duplicates some of the features found on the PLC menu bar.

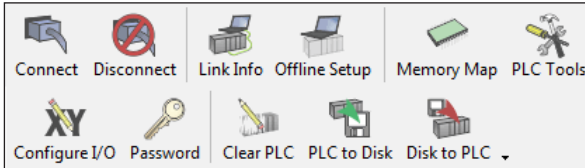

#### Connect to PLC

This button will allow the programmer to connect the PC to the PLC over a communication link. If a link has not been established, one can be setup here.

#### Disconnect from PLC

Use this button to disconnect the PC from the PLC.

#### Link Info

This button will open the Link Info dialog which will provide a quick overview of the current link's status and allows the programmer to edit and set the activation state of the link.

#### Offline Setup (PLC)

This button allows the configuration of the PLC type while offline.

#### Memory Map

Use this button to open the current PLC Memory Map.

#### PLC Tools

This button will open the Hardware Tools list. The programmer can select a software tool to run from this list as long as it has been installed.

#### Configure I/O

This button will open the Configure I/O window that displays the current configuration of the installed PLC I/O (Chapter 5).

#### Setup a Password

This button will allow the programmer to set a password in the PLC to protect the program from unauthorized access.

#### Clear Memory

Select this for clearing the memory in the PLC.

#### PLC to Disk

This button will allow the programmer to copy the configuration data from the PLC to disk.

#### Disk to PLC

This button will allow the copying of the configuration data from the disk to the PLC.

## The PLC Diagnostics Toolbar

The buttons on the Diagnostics Toolbar will only be active when the PC is online with the PLC.

### I/O Diagnostics

Pressing this button will perform diagnostics on the connected PLC.

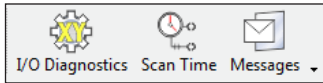

### Observe the Scan Time

Press this button to open the Scan Time dialog which allows the viewing of the current, minimum and maximum scan times from the current PLC. The scan times are continuously updated while the dialog is visible.

### View Error Messages

The messages button will open a window that displays System Errors and Fault Messages which have occurred.

## The PLC Setup Toolbar

Some of the buttons on the PLC Setup Toolbar can be used offline, but all of the buttons can be used with the PLC online (depending on the features of the current PLC).

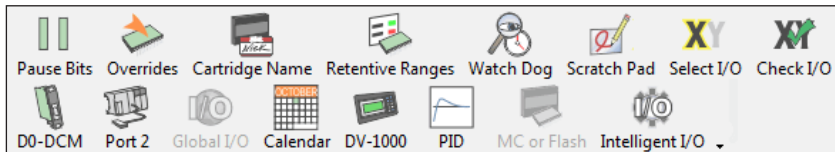

### Set the Pause Bits

Use this button to open the Pause Bit editor which allows the programmer to set output pause bits.

### Setup Overrides

This button will open the PLC Override editor.

### Name the Memory Cartridge

This will open the Memory Cartridge dialog used to set a name in the current memory cartridge in the PLC.

### **Set the Retentive Memory Range**

This button will open a Retentive Range dialog to configure the retentive memory for the current PLC.

### **Set the Watch Dog Timer**

Pressing this button will allow the programmer to view/edit the watch dog time-out value for the current PLC.

### **Initialize Scratch Pad**

Pressing this button will begin the process of Initializing the Scratch Pad Memory.

### **Select I/O**

This button is used to determine which I/O Config will be read from the PLC on power up.

### **Check I/O**

This button is used to turn on or off the I/O Config check when the PLC powers up.

### **D0-DCM Port Setup**

This button is used to setup the D0-DCM communication ports.

### **Secondary Port Setup**

Press this button to setup the PLC Secondary Communication Ports.

### **Setup Global I/O**

This button is used to setup the global I/O for the DL405 PLC only.

### **Set the Time and Date**

Press the **Calendar** button to set the time and date in the PLC.

### **Set up the DV-1000**

If there is a DV-1000 installed with the PLC, use this to open the DV-1000 setup dialog (refer to the DV-1000 User Manual for setup instructions).

### **Setup the PID Loops**

The **PID** button will allow the programmer to setup the PID loop parameters.

### **Select Memory Cartridge or Flash**

This button will allow the programmer to select the memory type for a DL405 PLC.

### **Setup Intelligent I/O**

Press this button to open the Intelligent I/O setup dialog to set up intelligent modules. The list contains configuration script for all intelligent modules in the current PLC.

## The Debug Toolbar

The Debug Toolbar extends the use of the Status button located on the Online toolbar. These buttons will assist in the debugging of your program.

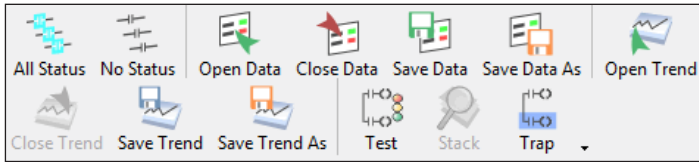

### Turn Status ON in All Views

The **All Status** button will turn on the status for all of the open views in the current project.

### Turn Status OFF in All Views

The **No Status** button will turn off the status for all of the open views in the current project.

### Open Data View

This button will allow the programmer to open an existing Data View.

### Close Data View

This button will allow the programmer to close the current Data View.

### Save Data / Save Data As

These buttons will save the current Data View.

### Open Trend View

This button will allow the programmer to open an existing Trend View.

### Close Trend View

This button will allow the programmer to close the current Trend View.

### Save Trend / Save Trend As

These buttons will save the current Trend View.

### Test Mode

This button will allow the programmer to use the Test Mode Operations (see page 10-22).

### Stack Operations (D4-440 only)

Use this button to monitor the D4-440 PLC accumulator and data stack.



### Trap Monitor

This button will open a dialog which allows the programmer to trap element values at specific addresses rather than after a scan (see page 10-25).

### The Window Toolbar

The Window Toolbar duplicates the window option from the main menu. This toolbar may be helpful if the window views need to be changed often.

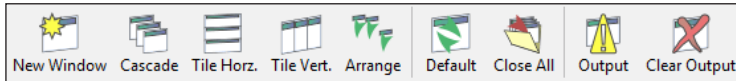

### New Window

This button will open a new View Window of the current Program View (e.g. Ladder, Stage, Trend, Mnemonic).

### Arrange Views Cascaded

The **Cascade** button will rearrange views in a cascaded fashion.

### Tile Views Horizontally

This button will arrange the program views in a tiled, horizontal fashion.

### Tile Views Vertically

This button will arrange the program views in a tiled, vertical fashion.

### Arrange Icons

Use this button to arrange the icons for minimized windows at the bottom of the main window. If there is an open document window at the bottom of the main window, then some or all of the icons may not be visible because they will be underneath this document window.

### Default

Pressing this button will restore window and toolbar positions to their factory default layout settings.

### Close All Views

This button will close all current views.

### Output Window

This button will display the Output Window.

### Clear Output Window

This button will clear all messages in the Output Window.

## The Help Toolbar

The Help Toolbar duplicates the Help menu accessed from the main menu.



### Help Topic Index

Use this button to open the Help window.

### PLC/Instruction Matrix

This button will open the PLC vs. Instruction Set Matrix window.

### Getting Started

The Start button will open the Help window to provide help to get started using *DirectSOFT*.

### DS On the Web

This button will open the *DirectSOFT* on the web window.

### Tip of Day

This button will open the Tip of the Day window to provide a helpful tip.

### Unlock

This button will convert *DirectSOFT*100 to full version using Purchased Product Keycode.

### About

This button will display the *DirectSOFT* about box.

## The Custom Toolbar

*DirectSOFT*6 has many toolbars to select, and if you select too many, you probably won't have much room on the monitor to effectively edit a program. The customize toolbar feature may be well suited for your use. Click on **Customize** at the bottom of the Toolbars menu to open the Customize toolbar window.

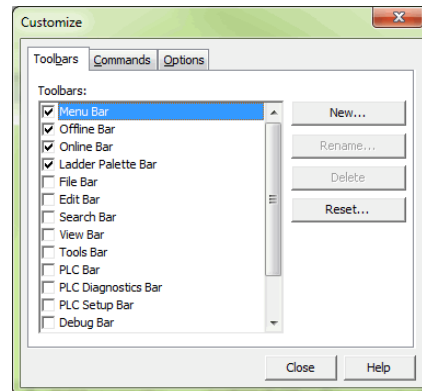

**TIP:** A quick way to open the Customize Toolbar dialog is to right-click on any of the Toolbars in view. This will access the Toolbars menu, then select Customize.

## Chapter 4: Programming Environment

The **Customize** window will allow the programmer to select all the toolbars he wishes to use, or to customize a personal toolbar. When a toolbar is checked (clicked on) it will be added to the programming window immediately. To create your personal toolbar click on New and name the toolbar. “**My toolbar**” is the name given to a custom toolbar in the diagram below.

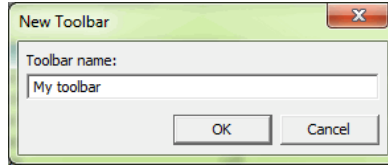

The toolbar will be added to the programming window as an add-on toolbar. The toolbar will not have any icon buttons in it until the programmer selects the buttons. To do this, click on the **Commands** tab and select the command category.

Once this is done, a list of icon buttons will appear to the right of the category list. Drag the commands that you wish to the personal toolbar.

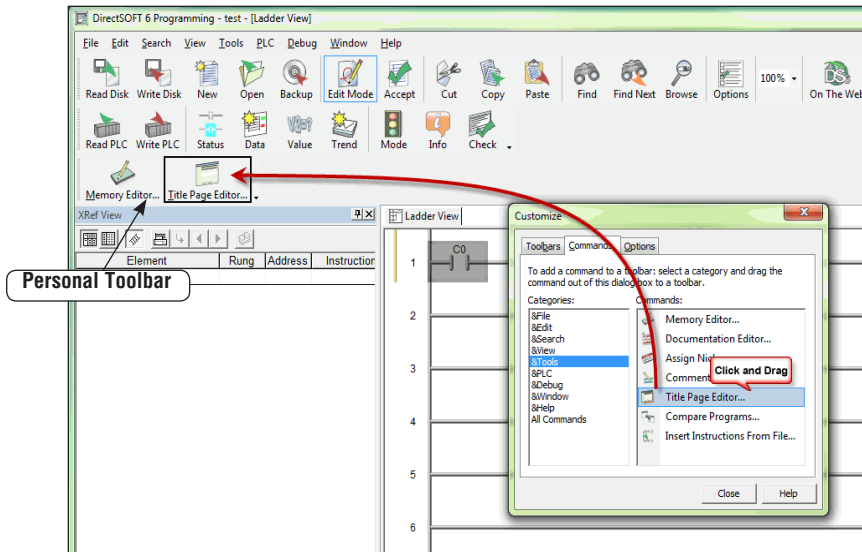
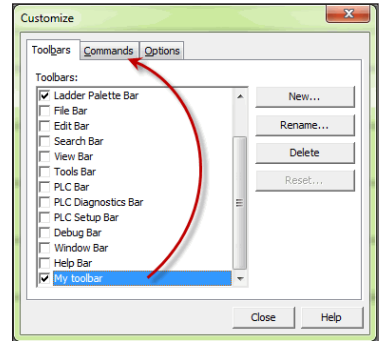

## Status Bar Components

The PLC status information is located at the bottom of the programming window. This area is divided into boxes which contain pertinent information about the PLC operation and status when the PLC is online or offline. These boxes can be classified as status buttons.

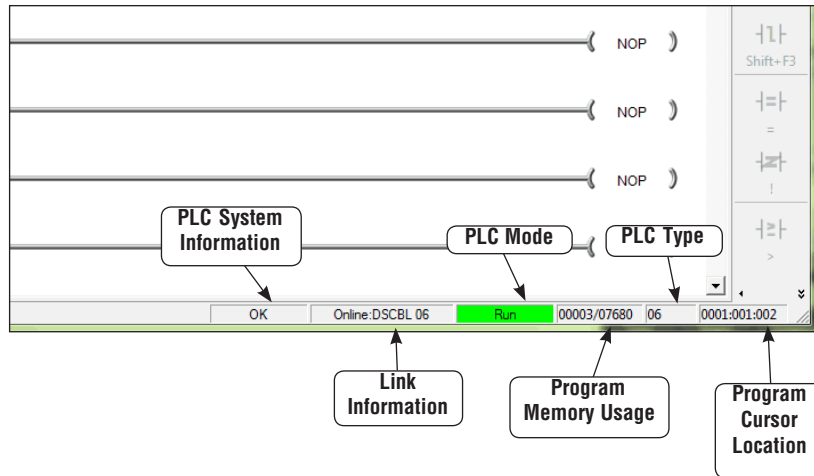

### PLC System Information

This status button is active whenever the PLC is online. It displays **OK** to indicate the PLC is running without an error. Clicking the button is like using the System Info button in the online toolbar. It will open the PLC System Information window.

### Communication/Link Information

This status button is active when the PLC is offline or online. The button displays the PLC status and the communication link name. Clicking this button will open the Communication/Link Information window. The window will show the communication error messages. It is also possible to edit the communication link if it becomes necessary. If the PLC is offline, it will indicate that here. Clicking on the button with offline showing will allow the programmer to connect the PLC to the PC.

### PLC Mode

This status button indicates the operational mode of the PLC. Not only does this button indicate the PLC Mode but it also allows the programmer to use this button like the Mode button in the online toolbar. Clicking on this button will allow the person to change the mode of the PLC.

### Program Memory Usage

This box indicates the amount of relay ladder program memory that is available and how much has been used. The format is: *memory used/total memory* available. If the available memory is exceeded, an asterisk (\*) will appear beside the amount used. Here are some examples:

- For a DL06 CPU with program memory of 00003/07680 indicates that 3 words have been used out of a total of 07680.
- For a D2-230 CPU indicating the program memory with \*00725/00512. This means that the amount of words used has exceeded the total program memory available.

### PLC Type

This box indicates the type of PLC that is being used.

### Program Cursor Location

This box indicates the position of the program cursor in the Ladder View. This indicator changes with each movement of the cursor.

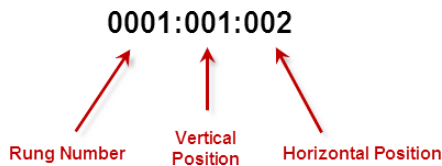

## The Options Dialog

Before continuing to edit your program, it is a good idea to get familiar with the *DirectSOFT Options Dialog*. This dialog actually has seven dialogs within which are used to setup the appearance of each of the views available. To open the dialog, either click on the Options button or on **View > Options**. Each view dialog is indicated by a tab labeled:

- Data View - used to monitor and debug the program
- Global - this affects all views (display of aliases or nicknames)
- Ladder - options for the ladder view
- Stage - options used for the stage view
- Trend - options used for data trending
- XRef - used to setup the cross reference view (display mode, documentation, etc.)
- XRef DB - definitions for cross reference database queries

Only the Global and Ladder options will be discussed in this chapter. The other option tabs will be discussed in later chapters after adequate coverage of some of the more advanced features of *DirectSOFT*.

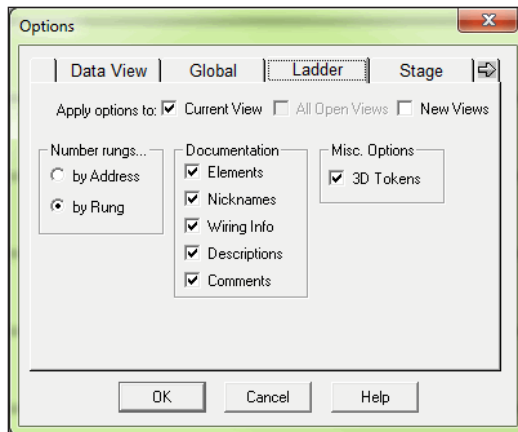

### Ladder Options

#### Number Rungs

Two choices are available here, **by Address** and **by Rung**. If by Address is chosen, the actual decimal address for the first instruction in each rung will be located in the left margin of the ladder view, starting with zero. If number by Rung is chosen, the rungs will be numbered beginning with the number one. The remaining rungs will be numbered sequentially, two, three, four, etc. The default selection is by Rung.

#### Documentation

This section of the dialog allows you to select the types of documentation that will appear in the Ladder Logic program. A check mark in the box preceding the option will select the option to appear in the program. The following choices are available:

- **Elements** - the element type and reference number (X1, Y3, C10, etc.)
- **Nicknames** - a name given to the element by the programmer or user (clamp, switch, etc.)
- **Wiring Info** - a descriptive tag for keeping track of wiring (Blue 027)
- **Descriptions** - notes attached to individual elements (gate open, clamp up)
- **Comments** - note attached to the rung, i.e., **This is the start of the Wash Process for Section 9 in Building 10**

#### Misc. Options

The only option available here is **3-D Tokens**. Leaving this option checked will leave the Ladder View the way it appears when it is first opened (default), that is, with a three dimensional effect on the Ladder View. When this option is unchecked, the Ladder View will have a white background and black rungs. This will not affect the colors of the displayed views.

#### Apply the Options to:

By default, the changed options will only affect the Current View. Check All Open Views or New Views if the changes are to affect other opened views or views to be opened later.

## Global Options

The options available with the **Global** tab affect the current and all new projects that are opened during any session.

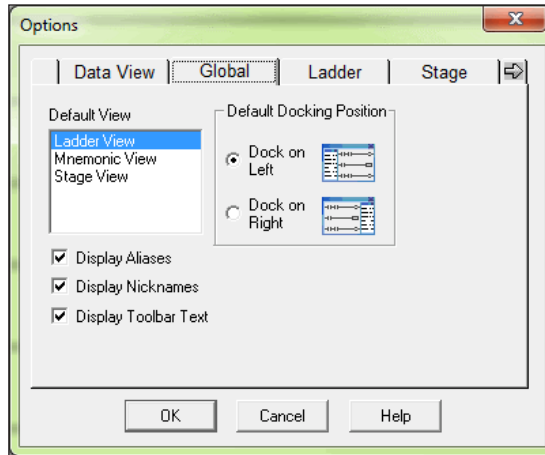

### Selecting the Global Options

- **Default View** - the view that is highlighted in the Default View window when the OK button is selected will be the default view that appears whenever a project is opened.
- **Display Aliases** - Aliases are alternate names given to certain elements or addresses. For example, **TA0** is an alias for a timer accumulator data starting at **V0**. It is much more meaningful to use the aliases rather than the counterpart memory address notations. But in the end, it is a matter of preference. The aliases can be turned ON or OFF globally. See the PLC User Manual for a complete list of aliases for the CPU being used.
- **Display Nicknames** - when this is selected, all current or future projects opened will display the nicknames. Selecting Display Nicknames here will have precedence over how this option is set for the individual views in the other options.
- **Display Toolbar Text** - this option allows the user to hide or display the text for each button in the Toolbars. When the text is hidden, the buttons reduce in size.
- **Default Docking Position** - this option allows the user to choose the position relative to the Ladder View that any Views opened (Data View, XRef View, etc.) will reside.



## Colors in *DirectSOFT6*

Colors are used in *DirectSOFT6* for personal customization and for certain information. The following will be a discussion of how and where colors are used.

### Select New Colors

The programmer can setup preferred custom color formatting for the projects to be developed. The selected colors will remain the same for each project. To open the **Color Setup** window, click on **View > Color Setup** or click on the **Color** button in the View toolbar button group. The Color Setup will appear like the dialog below.

The colors are changed by first selecting the usage (Normal Background, Comment, etc.) under the **Selection** section then clicking on the color in the **Colors** palette (drop-down menu). The **Sample** area (below the Color palette) has a color bar that will change as the colors are selected. Rows of text will also change color for each type of documentation selected. These are the rows of Cs, Ds, Ws, etc.

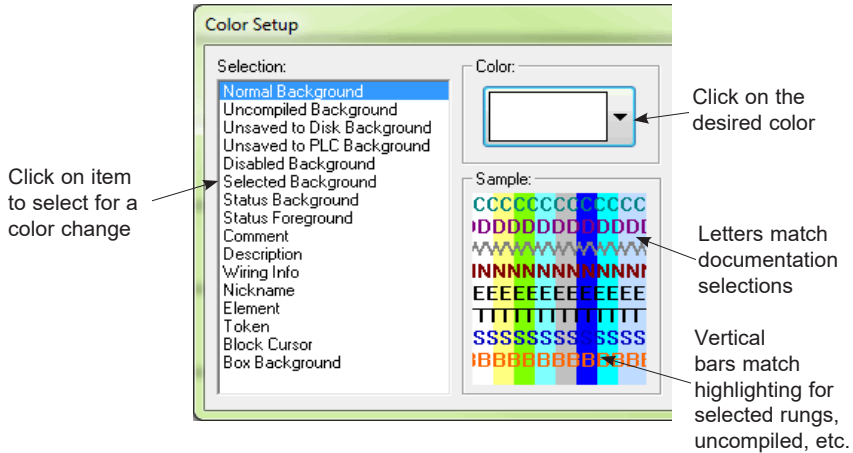

## Color Selections

**Normal Background** — the normal background color (the default is white with 3-D Token disabled).

**Uncompiled Background** — color for items which are modified and uncompiled.

**Unsaved to Disk Background** — color for items which are modified and unsaved to disk.

**Unsaved to PLC Background** — color for items which are modified and unsaved to the PLC.

**Disabled Background** — color for views which are disabled.

**Selected Background** — used for setting the color that appears when something in the program is selected. For example, if a range of rungs is selected (to copy, delete, etc.) the selection is highlighted with a color (default is blue).

**Status Background** — when online status is selected, this background color shows that the element is enabled (default is aqua).

**Status Foreground** — the color the individual element addresses show when they are active during status.

**Comments** — the color used for the rung comments.

**Description** — the color used for the element description.

**Wiring Information** — the color used to indicate the wiring information.

**Nickname** — the color used to indicate the nicknames.

**Element** — the color used for the element address (X10, IO000, etc.).

**Token** — the color used for the ladder program.

**Block Cursor** — the color of the cursor box in Ladder View.

**Box Background** — the color within each instruction box.

## The Default Settings

If the colors become totally disorganized, click on the **Defaults** button to restore the colors to the *DirectSOFT6* default settings.

## Monochrome

Selecting the **Monochrome** button will set all colors to black with a white background.

### Colors Conveying Information

*DirectSOFT6* uses different colors to indicate certain conditions. There are color coded vertical bars located in the margin to the left of the program rungs. These colored bars let the programmer know what has been compiled and saved. See the diagram below.

**Uncompiled Background** — when a rung is edited, a vertical colored bar (default yellow) appears to the left of the program as an indication that the program has not been compiled (accepted).

**Unsaved to Disk Background** — after the program has been compiled, the uncompiled bar is replaced with another bar (default green) to indicate that the program has not been saved the disk.

**Unsaved to PLC Background** — one other colored bar is used after a program has been compiled, this bar indicates that the program has not been downloaded to the PLC (default blue).

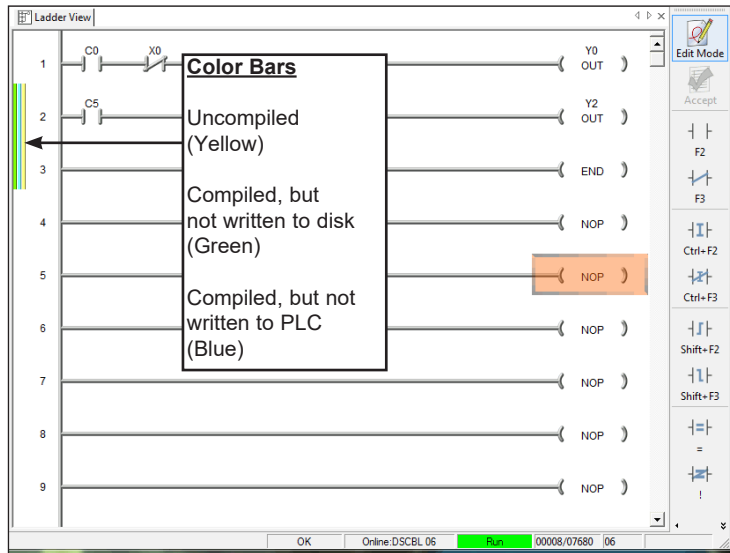

## Select a Theme

The **Themes** dialog allows the programmer to select the look of the *DirectSOFT6* programming window, much like selecting the appearance for a computer using Windows. To open the dialog window either click on **View > Themes** or click on the **Themes** button in the View toolbar button group. The default theme is Office XP.

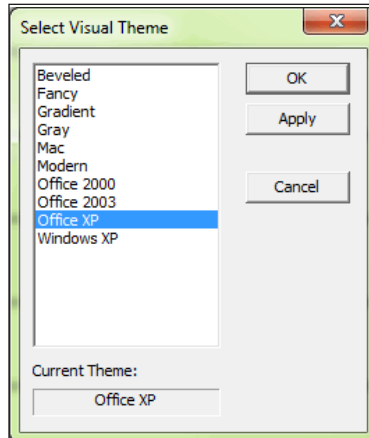

The theme selected for the window below is the Beveled look. Note the darkened outlines of the menu buttons.

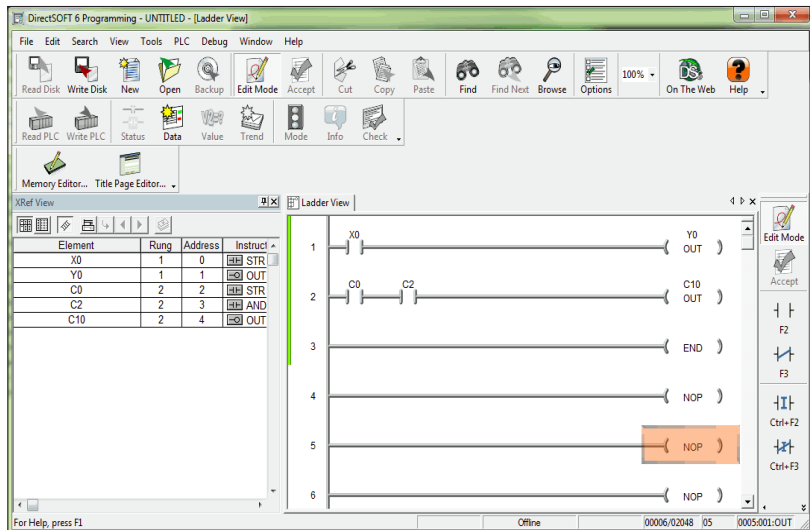

## The Ladder Palette

An important part of the programming environment is the **Ladder Palette**. The Ladder palette is visible whenever the programming window is opened. The element symbols are grayed-out and inactive when the not in the Edit Mode. Turning on the Edit Mode activates the Ladder palette and the tool symbols are no longer grayed-out. When a new project is started, the Ladder palette is located on the right side of the programming window by default, however, the palette floats. It can be moved to any position on the monitor viewing area. Simply “grab” the palette with the mouse arrow on the bar at the top of the palette and move it to wherever it may work best for the programmer. The palette can also be resized similar to the one shown on the facing page.

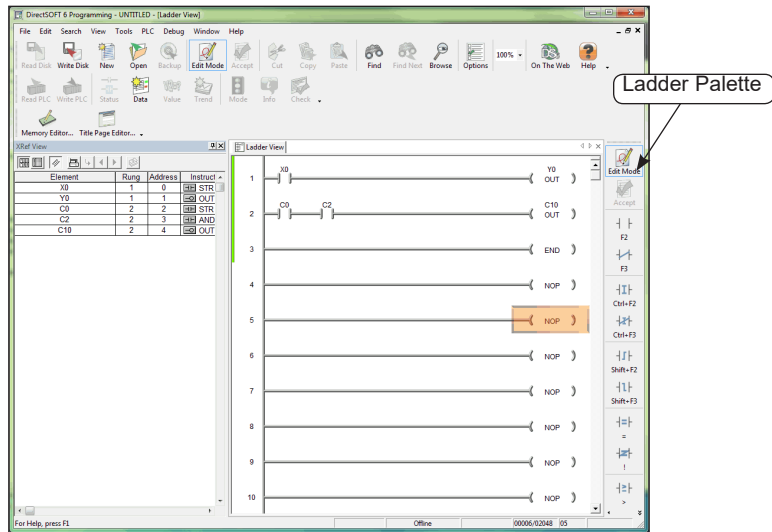

### Be Familiar with the Ladder Palette

The Ladder palette is very helpful when first learning to use *DirectSOFT6*. The hot keys can be learned while using the Ladder palette. The hot keys are labeled on the element keys. Using the hot keys may be quicker for many programmers. The hot keys appear in the “Tool Tip” whenever the cursor is over the element button.



**NOTE:** The Ladder palette which appears on your computer screen may be different than what is shown in this manual. The tools that appear are dependent upon the type of CPU being used.

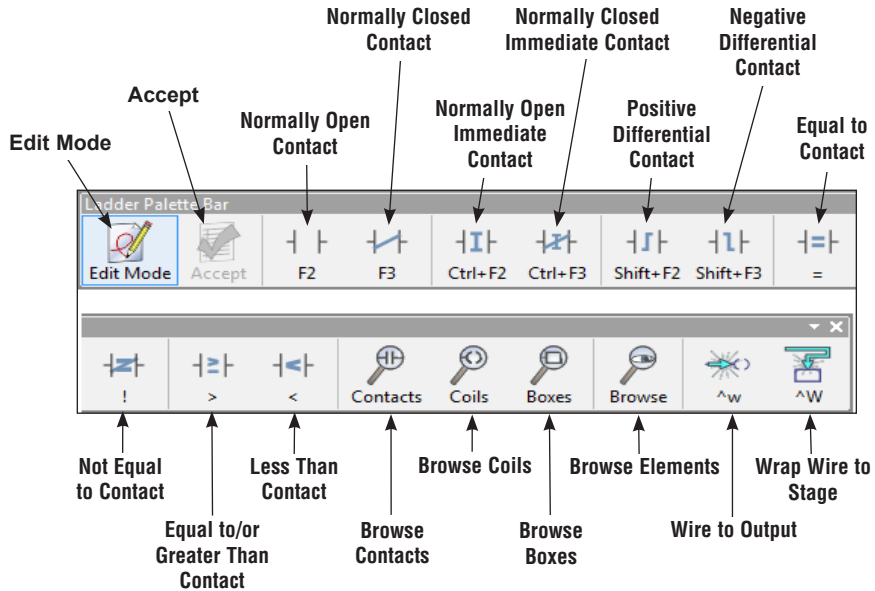

The contact buttons are self-explained. Each contact button will place the particular element on the rung wherever the edit cursor is placed.

**Browse Contacts** — click on this button to view the Contact dialog of the Instruction Browser to select a contact of your choice.

**Browse Coils** — click on this button to view the Coil dialog of the Instruction Browser to select a coil of your choice.

**Browse Boxes** — click on this button to view the Box dialog of the Instruction Browser to select an Instruction Box of your choice.

**Browse Elements** — click on this button to view the Element Browser which will allow you to select from various types of memory addresses (X0, Y0, V2000, etc.). This can be used to edit Nicknames, Wiring info or Descriptions of Elements.

**Wire to Output** — clicking this button will turn the horizontal wire between the last contact to the output ON and OFF.

**Wire to Stage** — click on this button to draw a powerflow transition between a contact and a Stage box instruction.

## The Split Screen Feature

There may be times when more than one part of the same program needs to be viewed. *DirectSOFT6* has a split screen feature that allows the programmer to split the program, horizontally, into two panes.

### Split Screen Bar

To use the split screen feature, there is a bar, Split Screen bar, located in the right-hand corner of the Ladder View. To split the screen, position the cursor over the Split Screen bar, then press and hold the left mouse button. When a parallel bar appears, move it down to bring the split screen into view and size the screen to your convenience.

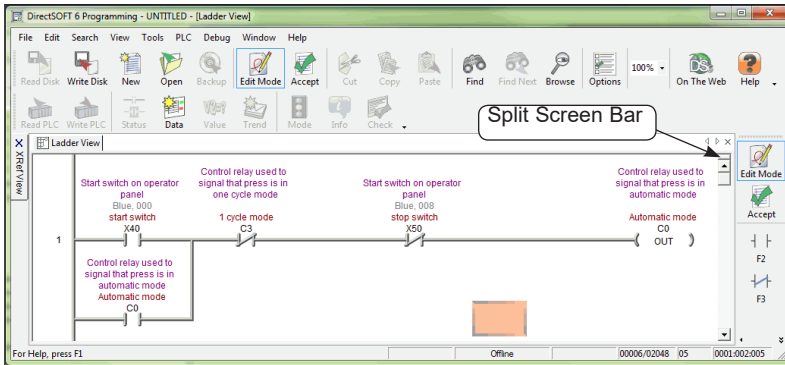

This diagram illustrates the split screen. Notice that the lower pane is showing a different rung than the upper pane.

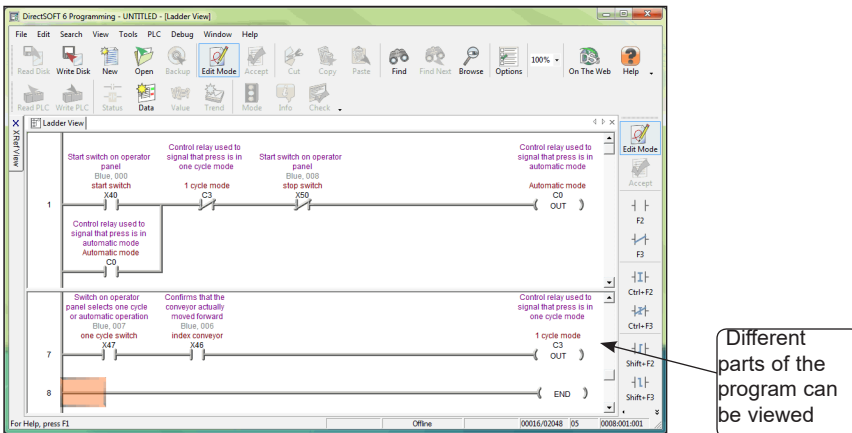

## The New Window Feature

Another handy feature of *DirectSOFT6* is the New Window feature. This feature is used to open two or more Ladder Views of the same program. Having two or more views open at once can be helpful when programming a lengthy program or to view two different parts of a program simultaneously. To open a new window, click on **Window > New Window**. You will know that there are two windows open by observing the two Ladder View tabs. To place the two views side by side, click on **Window > Tile Vertically**. The two views will be displayed like shown in the diagram below.

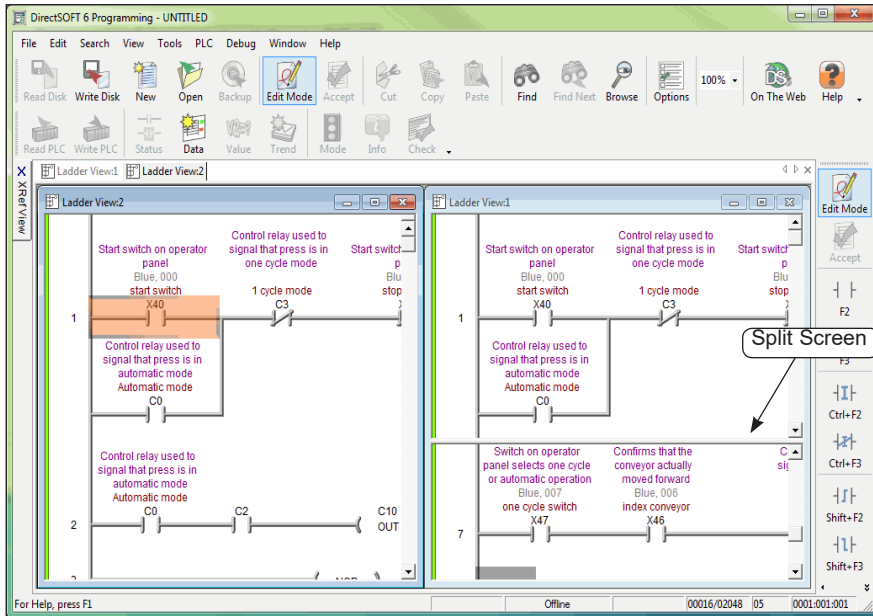

If the Window toolbar group is shown on the programming window, simply click on the **New Window** button then the **Tile Vert** button. If desired, the two views can also be arranged tiled horizontally. Notice that the split screen feature has been used in the diagram. Ladder View 1 has the split screen.



# EDIT A PROGRAM

---



## In This Chapter...

I/O Configuration .....	5-2
Referencing Program Elements.....	5-4
Entering Program Instructions.....	5-6
Shortcuts for Entering Instructions.....	5-11
Drawing/Deleting Connecting Lines .....	5-19
Selecting Rungs for Deleting, Cutting or Copying.....	5-21
Deleting Rungs .....	5-22
Copying Rungs.....	5-23
Cut and Paste Rungs .....	5-25
Merge (Combine) Rungs.....	5-26
Inserting Columns, Rows and Rungs .....	5-27
Using Search and Replace .....	5-29
Common Mistakes .....	5-31

## I/O Configuration

One of the first things to be done before beginning to edit a program is to view the I/O addressing for the PLC being used. Consult the user manual for the PLC that is being used to assist in the I/O configuration. The *Direct*LOGIC PLCs have automatic I/O configuration, and some of the CPUs offer manual I/O configuration.

To access the I/O configuration with *DirectSOFT6*, the PLC must be connected to the PC being used and online. Open the new program and connect the PLC to the PC. You can either select **PLC > Configure I/O** on the Menu bar or press the I/O Configuration button on the **PLC Toolbar** (the toolbar must have been added to the display window).

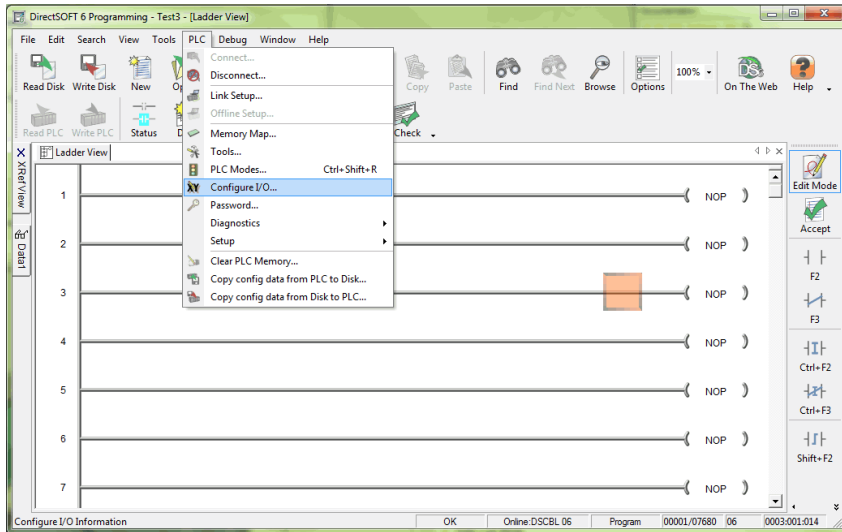

The Configure I/O dialog pictured on the facing page will appear showing the automatic I/O configuration (by default). If a CPU is being used that can be manually configured and the configuration needs to be changed, click on the “A” next to the slot that is to be manually addressed. The “A” will change to an “M” to allow the address to be changed.

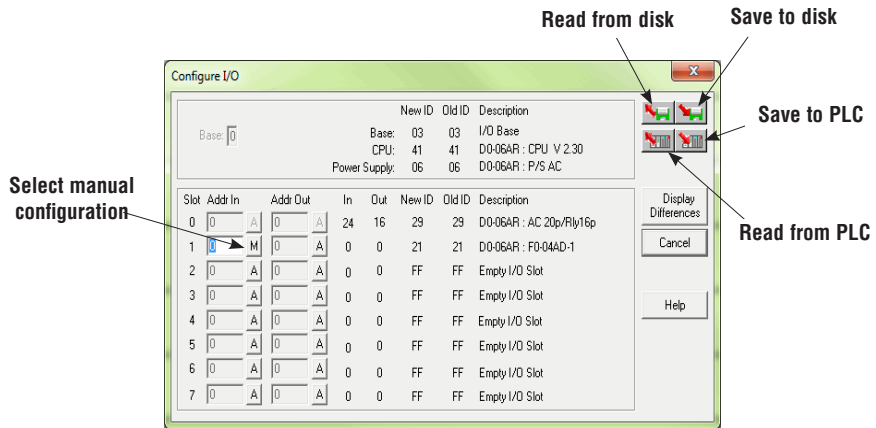

After the manual configuration has been set, save the configuration to the PLC and to the disk. The disk and PLC icon buttons located in the right-hand corner of the dialog allows the configuration to be either saved or read.



**WARNING:** The majority of *DirectLOGIC* PLCs only require automatic configuration. Do not use manual configuration unless it is absolutely necessary.

## Referencing Program Elements

### Data Types

It's good to know the various ways to refer to the different types of elements in the PLC. If you have used the *Direct*LOGIC compatible products, such as the TI305™, TI405™, or SIMATIC™ TI versions, you are probably familiar with the way elements are represented. The following table provides a complete list of the various data types and their meanings.

Type of Data	DL305C (D3-330/D3-340 CPU)	DL05/DL06/DL105 DL205/D3-350/DL405
Input Points	IO	X
Output Points	IO	Y
Control Relays	C	C
Stages	S	S
Timers	T	T
Timer current	TCA	TA
Counters	CT	CT
Counters current	TCA	CTA
Remote I/O Points	IO	GX/GY
Data Registers	R	V
Pointers (to another V location)	N/A	P
Special Relays	Uses special C locations	SP
Input Points as Registers	RIO	VX
Output Points as Registers	RIO	VY
Control Relays as Registers	RC	VC
Timer Status Bits as Registers	N/A	VT
Counter Status Bits as Registers	N/A	VCT
Remote I/O as Registers	RIO	VGX/VGY
Special Relays as Registers	RIO	VSP
Timer current Values as Pointers (to another V location)	N/A	PTA
Counter current Values as Pointers (to another V location)	N/A	PCTA
Constants	K	K
Octal Constants	N/A	O
Bit of Word	N/A	B
Pointer to Bit of Word	N/A	PB

## Aliases

Chapter 4 briefly mentioned the use of aliases to make some data references easier to understand. By default, they are displayed when you type their counterpart. If it is desired not to have the aliases shown when editing a program, they can be turned off in the Global dialog in the Options menu. Below are examples which show how aliases are used.



**NOTE:** These references are only used within **DirectSOFT**. They cannot be used with the Handheld Programmers. The actual instructions contained in the CPU will reflect the actual data type, not the new reference.

## Timer/Counter Current Values

The DL05, DL06, DL105, DL205, DL350 and DL405 CPUs use designated V-memory locations to hold timer and counter current values. The current value for Timer T0 is stored in V0. This is not always easy to remember, so **DirectSOFT6** allows you to refer to these as either **V0** or **TA0** (timer accumulated value for Timer 0). For example, the accumulator for Counter 3 is in CTA3 which is easier to remember than V1003.

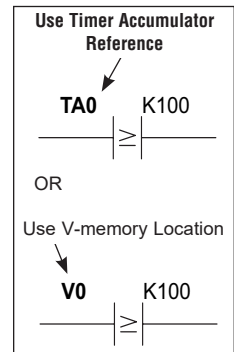

## Accessing I/O Points as Memory Locations

Aliases allow you to access I/O points as V-memory (registers in a DL305C). For example, input points X0 - X17 in a DL405 are stored in V40400, X20 - X37 are stored in V40401, etc. **VX0** (the alias) can be used instead of **V40400**, the V-memory location for X0. These are on 16-point boundaries, so the next location is **VX20**, **VX40**, **VX60**, etc. For the DL305C, you could represent I/O points such as **IO10 - IO17** with register location **RIO10**.

For example, you may want to read in a range of discrete input points to get a binary pattern into the CPU accumulator. The diagram shows two ways to reference the location.

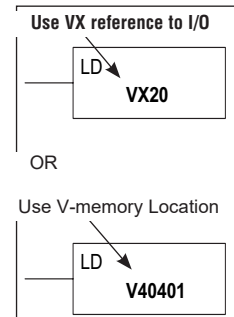

**NOTE:** Check the appropriate PLC user manual for a description of the accumulator and instructions required for this type of task.

## Entering Program Instructions

### The Instruction Editor

The Instruction Editor is a dialog used to enter element data for each type of instruction. The diagram below shows the dialog in the output entry position.

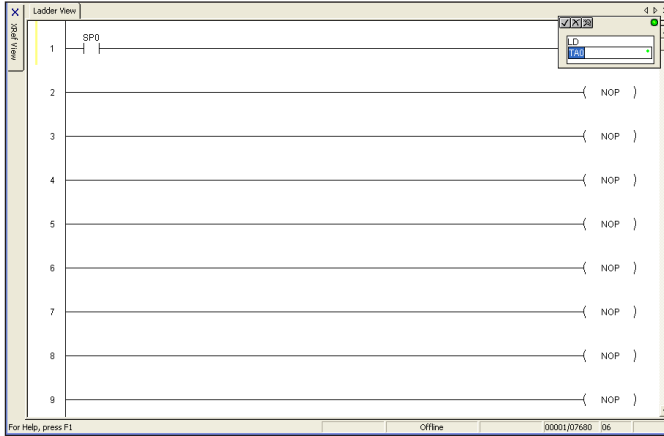

The expanded Instruction Editor dialog has a check mark, an X and magnifying glass in the upper left-hand corner. The check mark (✓) is used for accepting an entry. The (X) is used for closing without accepting an entry. And the magnifying glass will bring up the **Element Browser**, which will show the valid ranges for this field.

The small color-coded indicators in each field of the input box indicate whether the entry for that field is valid or not. **Green** is valid and **red** is not valid or incomplete.

The indicator in the upper right-hand corner of the box indicates the validity of all fields. For example, in order for the indicator to turn green, the box will need a valid address such as, V2000.

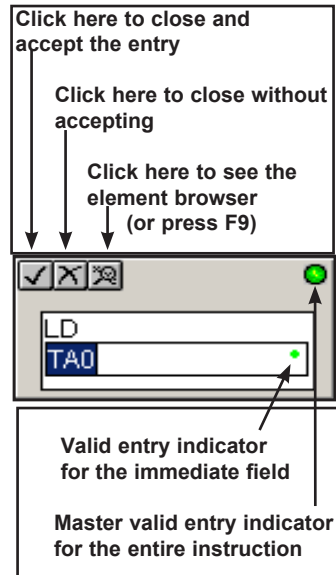

*DirectSOFT6* has two basic types of instruction editor dialogs: single parameter and multiple parameter. The following information explain the two types of dialogs.

### Single Parameter Instructions

Most contact, coil and box instructions have single parameters and are entered with the single parameter dialog. When some dialogs open for input, they automatically use a default element address. For example, if the Ladder palette button for a normally open contact is used, the Instruction Editor dialog box appears with C0 as the default. This is changed to another address or nickname that meets the program requirements. Click on the  $\checkmark$  to accept the entry, the  $X$  (or ESC) to cancel the entry, or on the element browser button (magnifying glass) to browse through the available element addresses or nicknames, or press **Enter** to accept the entry.

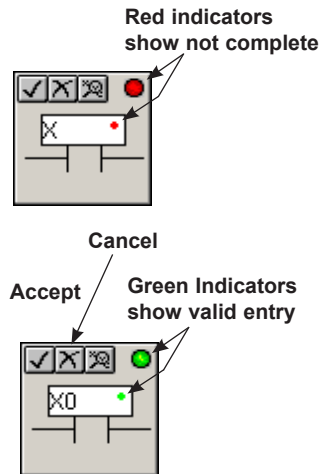

### Multiple Parameter Instructions

Some instructions, such as timers, counters and comparative boolean contacts require more than one element parameter. For example, for a timer, enter the timer number and a preset value. For a comparative boolean contact, enter the memory location and the value to be compared.

When the Instruction Editor dialog box appears for these instructions, the cursor appears in the first operand field.

**Do not press Enter when you complete this entry.** Press the Tab key or click on the second field for the next entry. For example, if entering a comparative contact, make the first entry and then press the Tab key to make the next entry. To return to the first field, press the **Shift + Tab** keys or simply press the Tab key again, and the cursor will wrap back around to the first field.

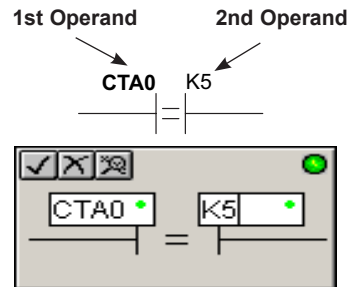

### Using the Ladder Palette

The Ladder Palette is always in view whenever the programming window is open in *DirectSOFT6*. The palette becomes active when the Edit Mode button is pressed. The palette is initially docked to the right of the Ladder view, but when the palette is floating, it can be positioned anywhere on the programming screen. Using the Ladder palette is one of several ways to enter instructions. First, place the edit cursor on the rung where an element is to be placed. Then click on the appropriate instruction on the Ladder palette. If one of the contact buttons (the top ten buttons on the palette), a dialog box will appear to enter the parameters.

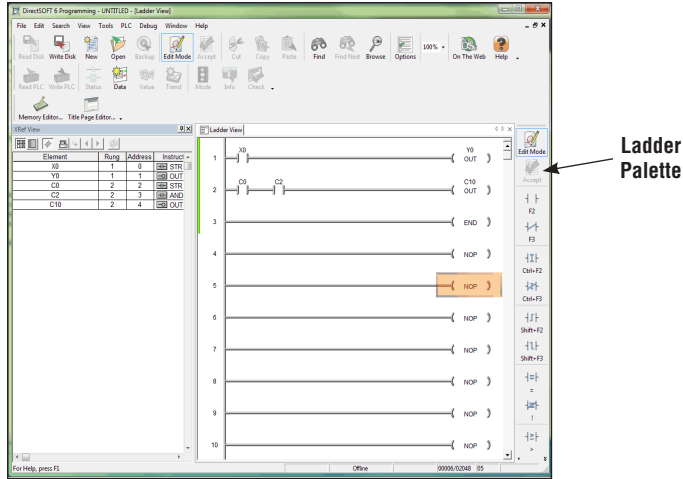

### Opening the Instruction Browser

Some instructions do not have an element button on the Ladder palette. To enter one of these instructions, click on the appropriate browser button on the palette and select an instruction. There are three buttons on the palette for browsing the contact, coil and box instructions. Clicking on any of the browse buttons will open the Instruction Browser, as shown on the facing page. This will allow selection of the correct instruction from the available lists. The particular browser that appears is dependent on the button that is clicked. Once a selection has been made and the OK button is pressed, the Instruction Editor will appear to have the appropriate information entered.



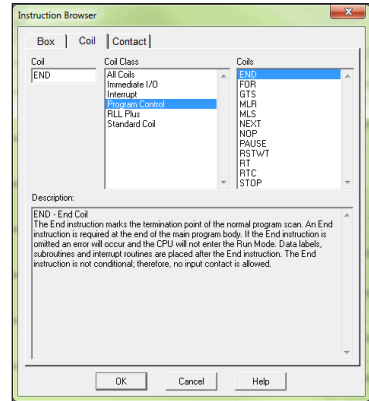
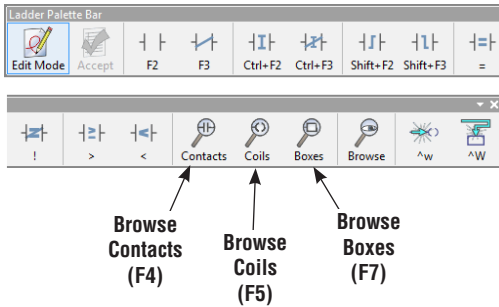

### Entering Instructions with Hot Keys

When the cursor is moved to one of the Ladder palette buttons, a Tool Tip will appear. The Tool Tips provide a brief description of the button and the associated hot key for that button.

You can enter an instruction by pressing the hot key which corresponds to the type of instruction to be entered. For example, to enter a normally opened input, press **F2**. After the hot key has been pressed, the Instruction Editor dialog will appear. For the browse buttons, the particular Instruction Browser will appear so the proper selection can be made.



**NOTE:** A complete list of the hot keys is available from the Help menu.

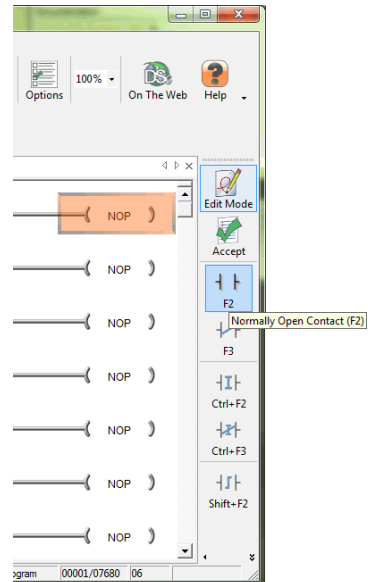

### Entering Instructions from the Menu Bar

Instructions can also be entered using the Menu bar which will open the Instruction Browser. Click on **Edit** and select the appropriate browser (contact, coil or box). This will open the Instruction Browser as if one of the browse buttons had been pressed on the Ladder palette.

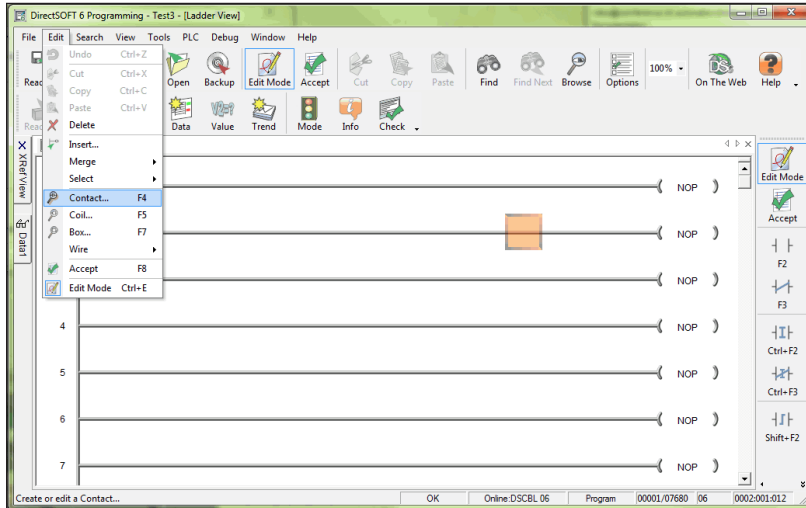

## Shortcuts for Entering Instructions

Once the programmer becomes familiar with *DirectSOFT6*, the most common method for entering instructions is to position the cursor on the rung where the instruction is to be entered and type the element address, i.e. X12, C22, Y14, etc. For an instruction box, type in the mnemonic, i.e. LD, OUT, SET, etc., and the Token Selection Editor will appear for a proper selection. Then press **Enter**.

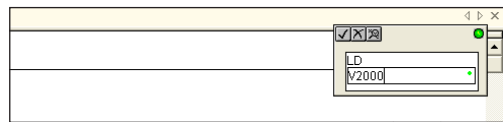
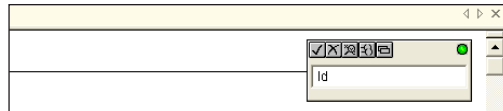

**NOTE:** Use the Ladder Palette, the hot key equivalent, or select the Coil or Box Browser to enter the OUT box instruction.



**TIP:** The Token Selection Editor feature in *DirectSOFT6* supports Auto Complete with a drop-down list of any matching instructions. For example, if a “TM” is typed over a NOP in the output column, an Auto Complete entry of “TMR” will appear with a list of all output instructions beginning with “TM”, including TMR, TMRA, TMRAF and TMRF. After the proper instruction is selected and entered, the proper Instruction box will appear to be completed with all the proper information. So, if you forget a mnemonic, just enter the first couple of letters to see a list of possible instructions.

### Entering NO and NC Contacts

Another quick method for entering contacts is to use the **forward slash (/)** to toggle between a normally open and a normally closed contact. For example, if X0 was entered as a normally open contact and a normally closed contact is needed instead. Position the cursor over the contact and type X0, then press the (/) key and enter. Just reverse the steps to return the contact to a normally open contact.

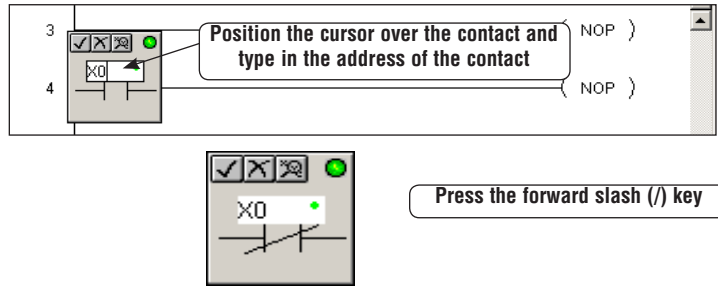

**NOTE:** The forward slash can also be used to switch between OUT Coils and OUT Boxes, as well as cycling between the various rung inline comparison statements (Equal, Not Equal, Greater than, Less Than, etc...)

Here are two more shortcuts that can be used when entering elements in your program. The first shortcut requires the Edit cursor to be placed on the rung where a NO contact is to be entered. Type the element address and enter it. The edit box will appear so you can either enter the address or change the contact to NC.

The other method is to double-click on the rung where the element is to be placed. Again, the edit box will appear with a NO contact. Enter the address and/or change the contact to NC and press enter.

## Entering Instructions in Parallel

To enter instructions in parallel, make normal contact entries similar to the below diagrams. Two contacts have been entered on Rung 2. With the cursor located after the last contact entry, press **Enter**. The cursor will move down a space equivalent to a rung. Make another contact or contact entries, such as two more contacts in the illustration below. Once this is done, hold down the **Ctrl** key and press the **up arrow**. This will draw a line up to connect the line above. Editing the rung can now be completed.

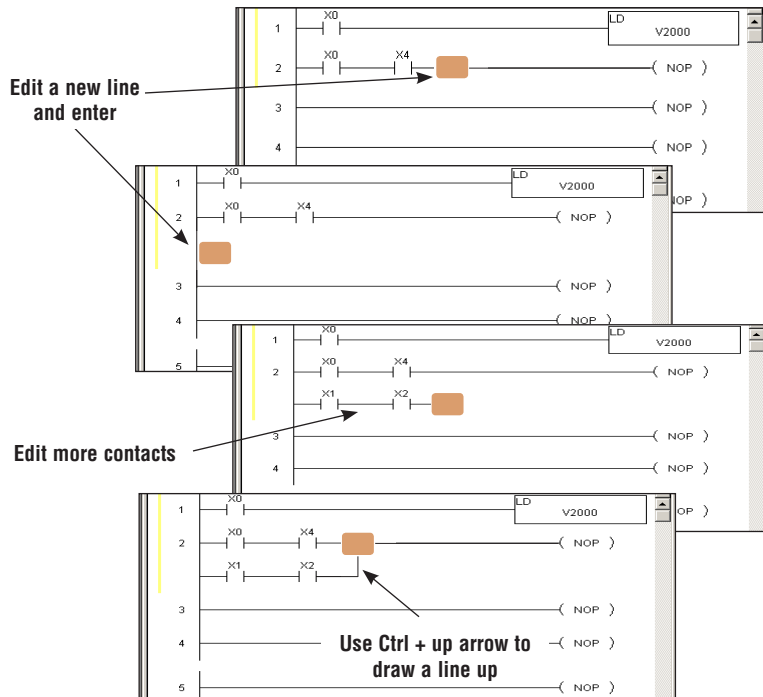

Draw Rung Lines	
Key Stroke	Function
Ctrl +Up Arrow	Draw a vertical line up
Ctrl +Down Arrow	Draw a vertical line down
Ctrl +Left Arrow	Draw a horizontal line left
Ctrl +Right Arrow	Draw a horizontal line right



**NOTE:** To delete lines, press and hold **Shift + Ctrl**, then press the appropriate arrow key.

### Entering Power Flow Instructions

There are some instructions, such as **Master Control Relays (MLR/MLS)**, **FOR/NEXT loops**, **Stage Boxes (SG, ISG)**, **Program Control (GOTO/LBL, INT, SBR)**, etc., that offset the power rail or are inserted in the power rail of the ladder program. A common mistake among new users of *DirectSOFT6* is to try and edit the offsets using the **Ctrl + Arrow** (line connector). **This will not work.** Actually, *DirectSOFT6* will automatically perform the offset whenever the program is accepted (compiled). This will become clear through the examples on the immediate two pages. For this example, the **FOR/NEXT** instruction will be used and the hot key, **F8**, will be used to accept the program.

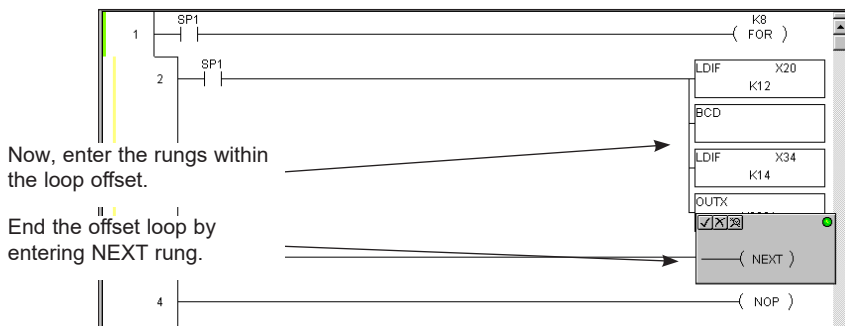
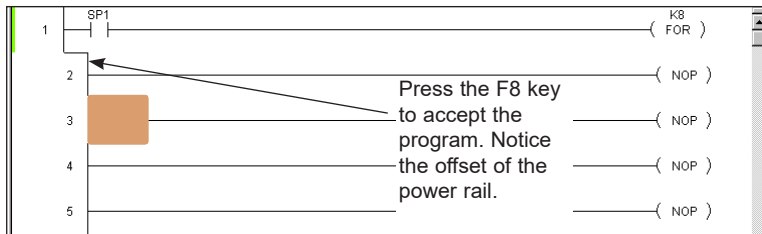
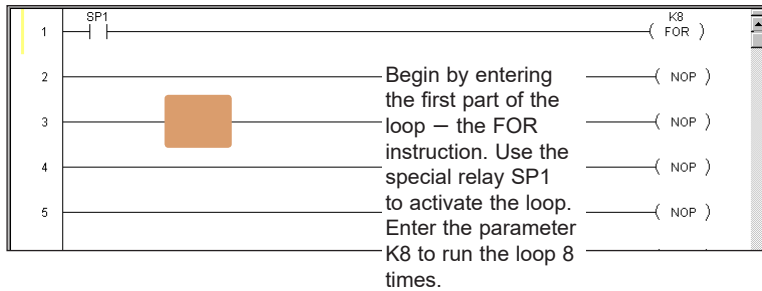

After the program has been accepted, the power rail will show the offset.

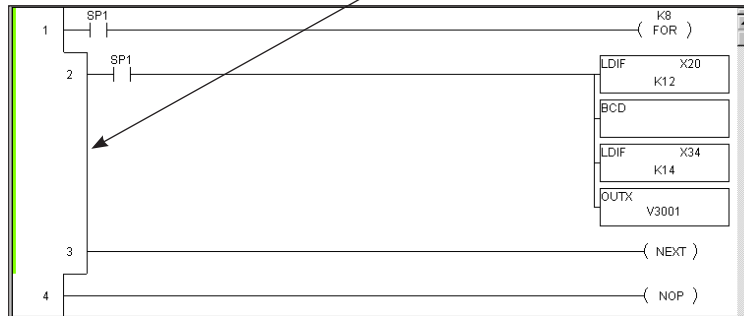

**NOTE:** Refer to the PLC User Manual to learn how to use the Power Flow instructions. Some of the instructions of this type may not be available for the PLC that is being used.

### Entering Special Case Elements

Some elements are special because they do not follow the usual rules (i.e. D3-330S Timers/Counters, D3-330/D3-340 CT674-CT677) or they are entered in, perhaps, different ways than one might expect. This will be discussed on this page and the following page.

If you have a D3-330, D3-340 or compatible PLC, then you know the counters/timers CT674 through CT677 cannot take software presets in the same manner as all its other built-in counters/timers. These counters/timers are designed to have their presets entered via an external hardware device (D3-TCSU Timer/Counter Setpoint Unit). **Preset values cannot be entered for CT674-CT677 via the timer/counter entry dialog.**

This presents a unique situation for *DirectSOFT6* because for these two CPUs, *DirectSOFT6* will always show two input fields (timer/counter address and preset) for all of its timers/counters and makes no exception for these special cases. The element can be entered in the ladder logic, but the second field is ignored in the editor dialog. **The edit dialog will not allow a preset to be entered.** This Second field is intended for presets on all other timers/counters, and not these being discussed. Once the address has been entered in the aforementioned timers/counters, just press enter to close the box. The preset entry will be made via the D3-TCSU thumbwheels, and the preset can only be viewed on the Setpoint Unit.

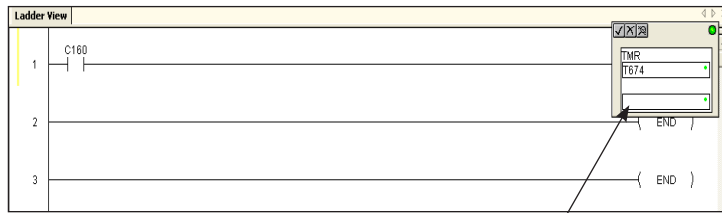

A preset cannot be entered for D3-330/  
D3-340 Timers/Counters CT674-CT677.  
Leave the preset field blank.



### TI330S/TI325S and D3-330P Exceptions

If you have a TI330S/TI325S or D3-330P, then the situation will be slightly different from the one explained on the previous page. These CPUs do not allow presets for any of their counters/timers via the edit dialog of *DirectSOFT6*. It is sometimes confusing to users of previous versions *DirectSOFT* with other PLCs because of the preset entry. The preset for the counters/timers being discussed do not need a preset entry in the edit dialog. The only entry to be made in the edit dialog is the counter/timer address. Refer to the PLC User Manual for a detailed discussion of how these timers work with their presets.

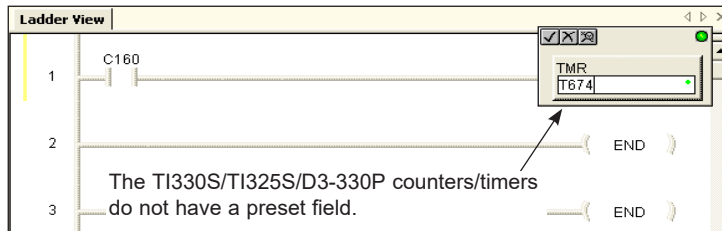

### End Coil

All of the instruction sets in *DirectLOGIC* PLCs and compatibles, use an END coil as one of the instructions. This may be a bit different for new users of *DirectLOGIC* PLCs. The END coil is a marker to designate the end of a program. Every *DirectSOFT6* program must have this instruction.

Like all coils, the END coil is found in the Coil Instruction Browser. Some programmers get confused at first and look for the END coil under the Standard Coil category, and they fail to find it. The END coil is located under the Program Control category since it ends the program.

The END coil is found under Program Control and not under the Standard Coil category.

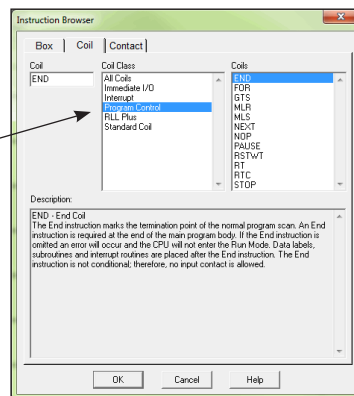

### Setting and Resetting a Bit

Several PLCs in the *DirectLOGIC* family have a feature that allows setting and resetting individual bits. This is commonly called “Bit-of-Word”. The PLCs which support this feature include the DL05, DL06, D2-250-1, D2-260, D2-262, D4-450 and D4-454. The *DirectSOFT6* instructions available for these PLCs offering Bit-of-Word include all of the **STR**, **AND**, **OR** and **OUT** instructions and all **SET** and **RST** instructions. Notice SET and RST examples shown below, the letter ‘b’ precedes the memory location where the bit is to be manipulated in some way. After the V-memory address of the word, use a decimal point and a number between 0 and 15 (zero being the least significant bit) to designate which bit is to be set. For example, b1400.3 is the fourth bit of V1400.

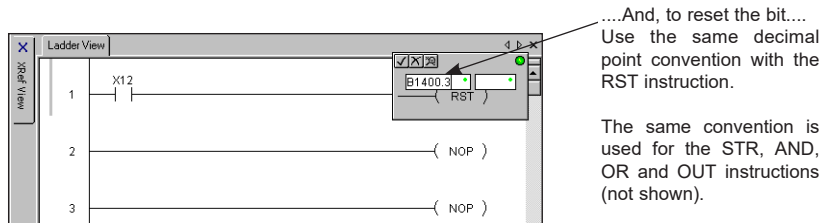
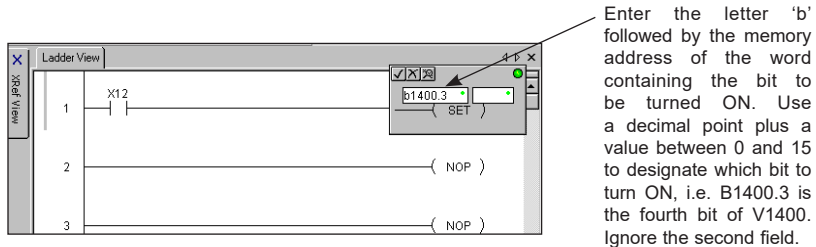

**NOTE:** The letter “b” can be entered in either lower case or upper case. The end result will be an upper case “B” appearing in the program.

### Using Floating Point Math

Small, low-end PLCs typically allow the use of integers, but do not allow the use of math containing decimal places. The second type of math just mentioned is called “floating point” math. If the processor for your PLC supports floating point math i.e., DL06, D2-250-1, D2-260, D2-262, D4-450 and D4-454, it’s a good idea to learn the conventions used for entering the floating point math elements and parameters. Refer to the user manual for the PLC which you are using.

## Drawing/Deleting Connecting Lines



**WARNING:** As you read this section pertaining to connecting lines, be aware that elements that have not been connected will be deleted when compiling your program. *DirectSOFT6* will display a warning if there are unconnected elements, and asks if you wish to go back and connect the “dangling” instructions. How to compile all edits is discussed at the end of this chapter.

### Drawing the Lines

Most programs contain a wide variety of rungs with complex series and parallel element connections. Most any networks can be built by connecting the contacts, outputs, etc. with horizontal and vertical lines. Enter these lines (refer to Page 5-13) by using the Ctrl key and the arrow keys. For example, press Ctrl + ↓ to draw a vertical line from top to bottom or press Ctrl + → to draw a horizontal line from left to right. Below is an example network containing combinations of series/parallel elements.

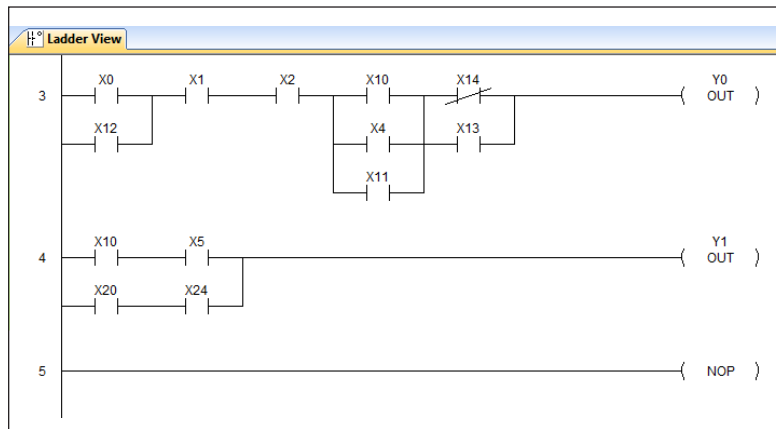

### Create Midline Outputs

There are times when you need to use a diagram that is often referred to as a midline output. There are no special procedures required. Enter the contacts and outputs as normal, and use the **Ctrl** and arrow keys to draw the connecting lines. Below is an example of how a midline output would appear.



**NOTE:** There cannot be any additional logic on the rung between the midline connecting point and the output. See *Compiling Errors at the end of this chapter*.

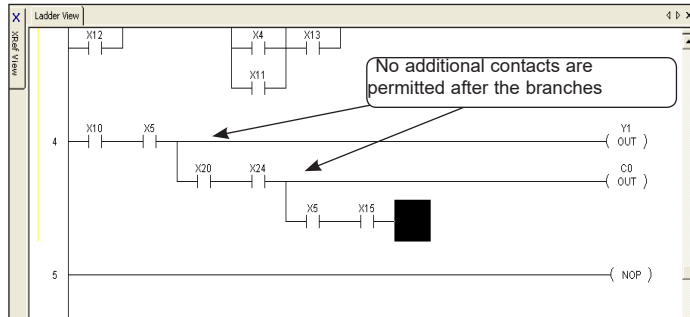

### Deleting Connecting Lines

Deleting lines is similar to creating lines. Use the **Edit > Wire > Delete** options on the Menu bar or the keyboard **Delete** key to delete instructions and wires in all directions. A quicker method is to use the **Ctrl + Shift + Arrow** keys to delete the lines. Below is an example illustrating how to delete lines.

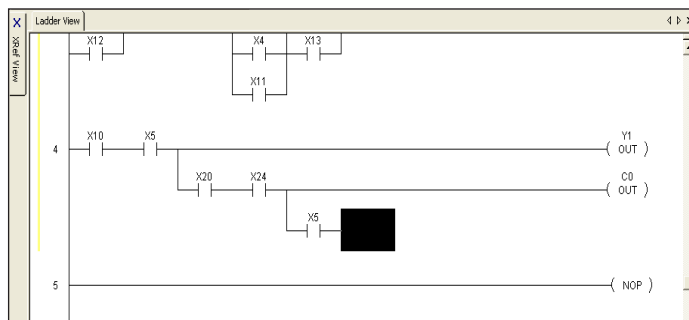

In this example, use **Ctrl + Shift + ←** to delete the instruction to the left of the cursor along with the connection wire.

## Selecting Rungs for Deleting, Cutting or Copying

While developing the program, there will be times when you will want to make revisions or correct mistakes. Also, there may be times when a rung needs to be moved (cut and paste) to another location in the program. Or, there may be a rung or rungs that you want to duplicate or repeat several times (copy and paste). The next three pages will illustrate how to do these tasks.

The first step to cut, copy or delete rungs is to select them with the Shift + Arrow keys. The selected rungs will be highlighted (default color is blue). The following screen shows an example where a rung is selected to be either deleted, cut or copied.

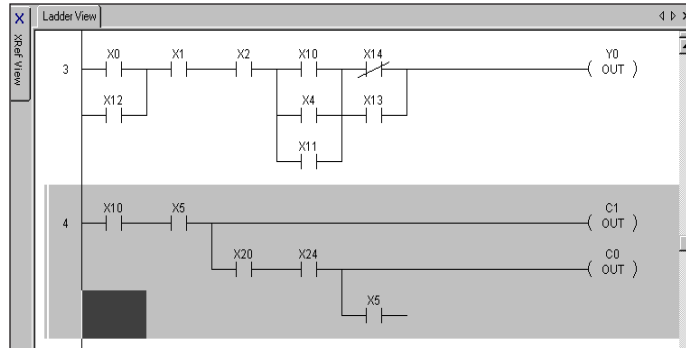

**TIP:** Use shortcuts to quickly select portions of the program

Shift + Home selects all rungs from the current rung to the beginning of the program.

Shift + End selects all rungs from the current rung to the end of the program.

## Deleting Rungs

When deleting one or more rungs, it is with the intention of removing the rung(s) from the program entirely. Delete them by pressing the **Delete** keyboard function key, or by using the **Edit > Delete** option from the Menu bar.

First, select the rung or rungs to be deleted.

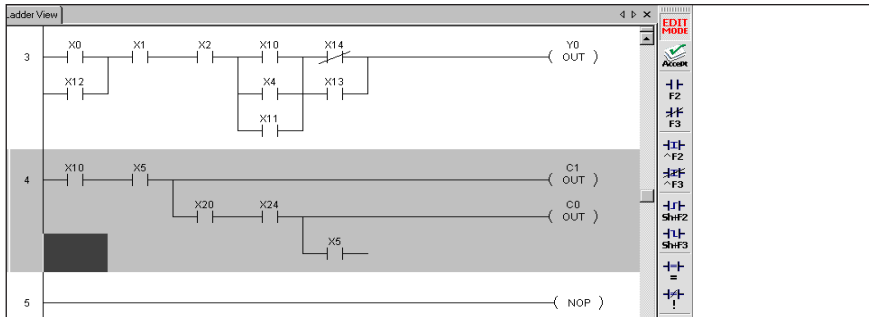

Then, press the **Delete** key, and the rung or rungs will be removed.

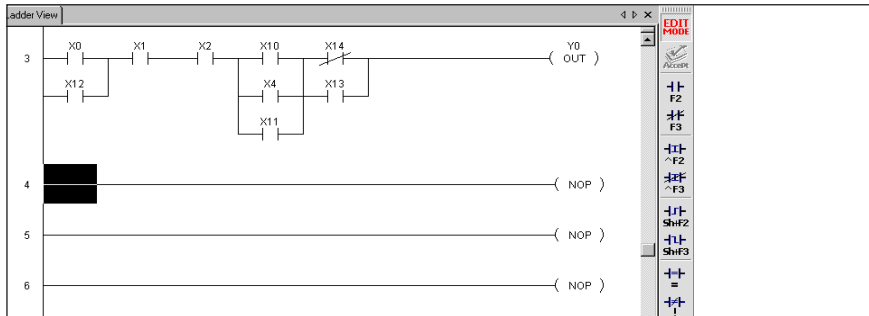

## Copying Rungs



A selected rung or rungs can be copied and pasted to another location in your program (or to another open program in Edit mode) by using the keyboard shortcut **Ctrl + C**, **Edit>Copy** from the Menu bar or the **Copy** button on the Offline toolbar. The original rungs will not be altered in any way. When the rungs are copied, they are placed in a temporary storage location called a clipboard.

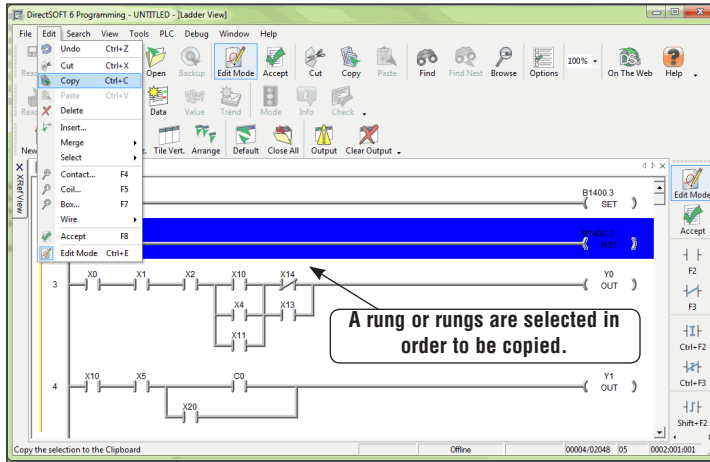

The copied rungs are held on the clipboard until pasted to the new location with **Edit > Paste** from the Menu bar, the **Paste** button on the Offline toolbar or **Ctrl + V** (keyboard shortcut). The clipboard is updated whenever a different rung is copied; in other words, the clipboard will only hold one copy at a time.

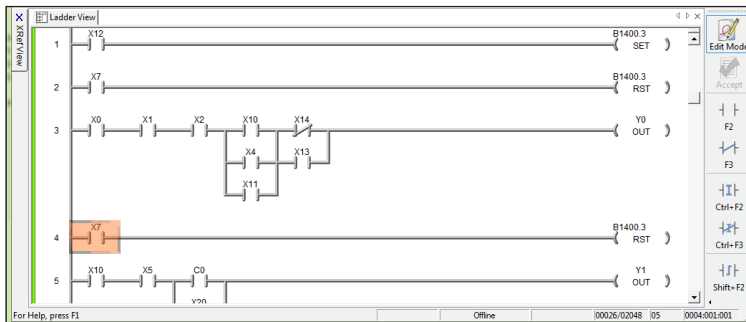

The above example shows the copied rung pasted from the clipboard to a new rung location in the program (Rung 4).



**WARNING:** When using Stage instructions, be careful where copied rungs are pasted. This is only true for pasting a rung to an unconditional output that follows a Stage box.

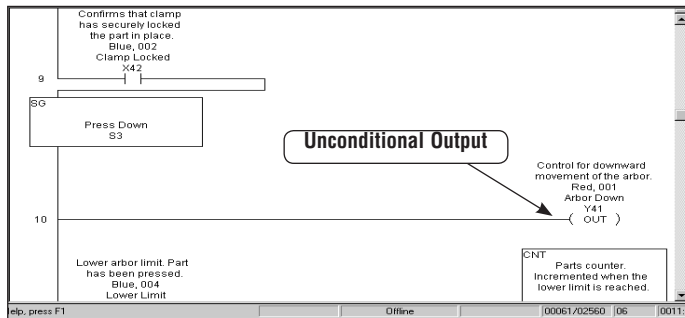

When pasting the copied rung, the unconditional output will be joined to the copied rung. The following example shows the output now being controlled by a conditional input, which was not the intent of the original program.

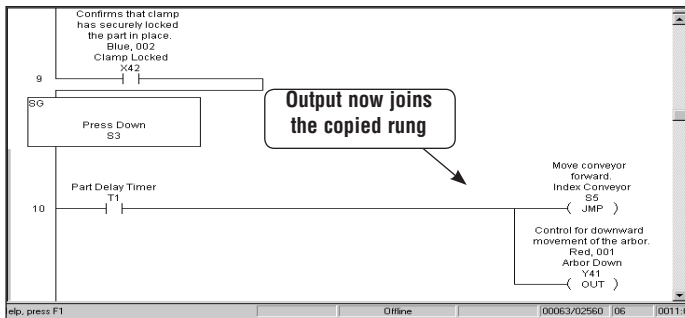



## Cut and Paste Rungs



Selected rungs can be moved to a different location in your program by using one of these methods; **Edit > Cut** from the Menu bar, **Cut** button on the Offline toolbar or **Ctrl + X** (the keyboard shortcut). The cut rung (or rungs) is stored on the clipboard until it is pasted at a new location.

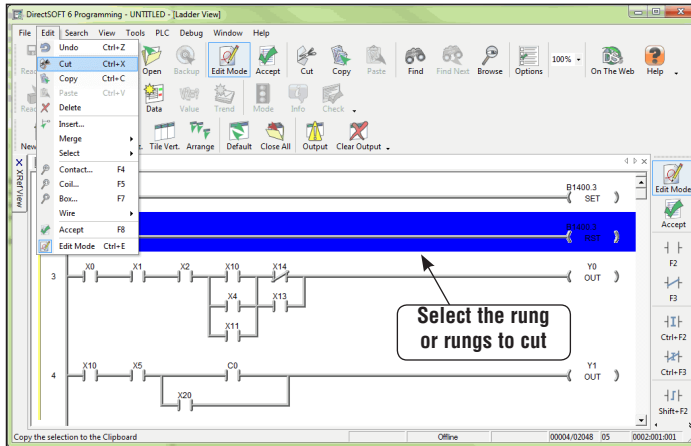

The cut rungs are held on the clipboard until pasted to the new location with **Edit > Paste** from the Menu bar, the **Paste** button on the Offline toolbar or **Ctrl + V** (the keyboard shortcut). The cut rungs will remain on the clipboard until pasted or a new rung is either cut or copied. The clipboard will only hold one selection at a time. To paste the rung (or rungs) to the new location, place the cursor on the rung below where the rung will be inserted. The rung will be inserted above the rung where the cursor was placed.

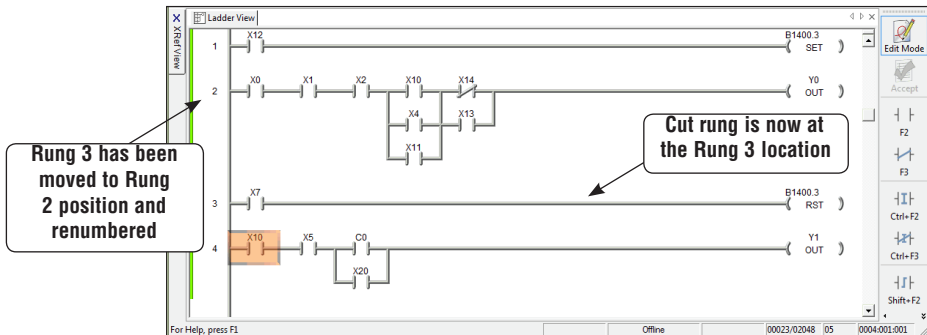

## Merge (Combine) Rungs

At times, it may become necessary to combine two rungs into a single rung. *DirectSOFT6* will allow you to merge the two rungs. Once the two rungs are merged, you will need to combine the components in the new rung through the normal edit process.

To use the merge feature, position the Edit cursor on the rung that you intend to merge with the rung right before or after. Next, select **Edit > Merge** then select **Previous Rung** or **Next Rung**. You can also use the **Merge Next** or **Merge Previous** buttons in the Edit toolbar. The rungs will be merged into one rung. Both rung comments will be used as the rung comment for the newly merged rung. See the example diagrams below.

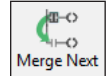
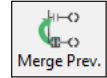

The screen below shows Rungs 4 and 5 merged, renumbered as Rung 4 and ready to be edited. Also note the original Rung 5 comment has been combined with the Rung 4 comment.

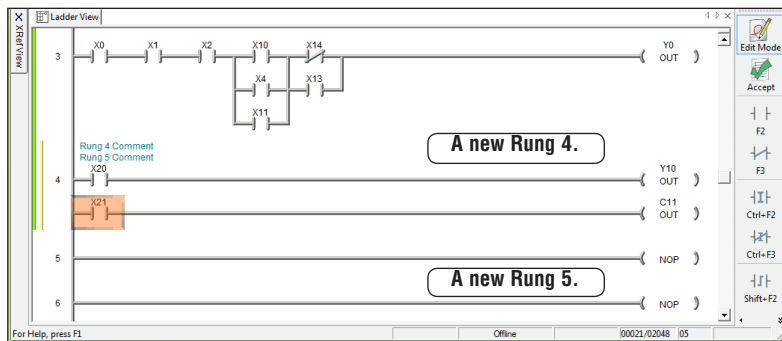
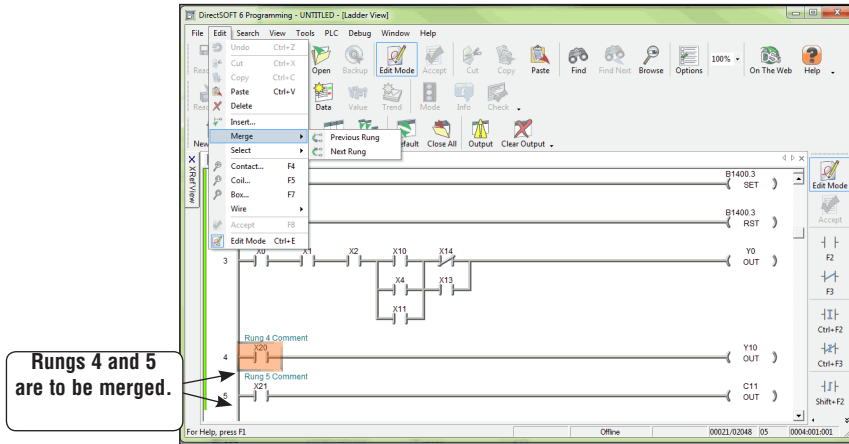

## Inserting Columns, Rows and Rungs



Inserting instructions and rungs is a simple process with *DirectSOFT 6*. To perform either of these features use **Edit > Insert** on the Menu bar, the **Insert** button on the Edit toolbar or the **Insert** keyboard function key. When instructions or rungs are inserted, the addresses and rung numbering will change.

### Insert a Column to Add an Instruction

There may be a time when you need to add an element in a rung of a program, such as within a parallel connection in the rung. To do this, a column is inserted to spread the rung out where the element is to be added.

In the example diagrams below, a contact is to be added after X0 in Rung 3. The cursor is placed over X0 then the Insert feature is accessed by one of the three ways mentioned above. An **Insert** dialog will appear asking what you want to do. Make the proper selections and press **OK**. In the example, **Column** and **After Cursor** is selected. **Before Cursor** could have been chosen. It depends where you want to place the new contact. Only one rung is affected in the example.

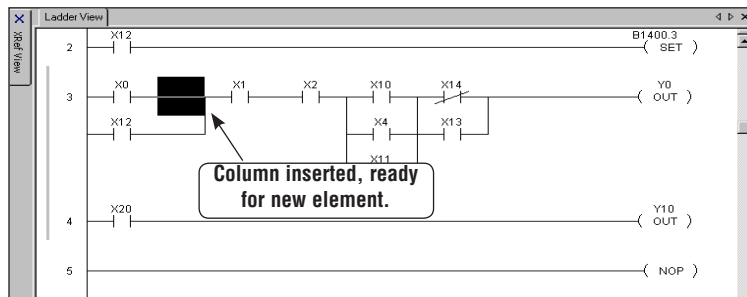
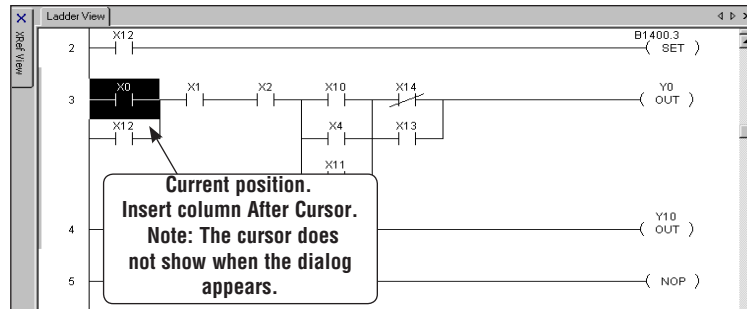

## Insert a Row or Rung

Inserting a row is performed the same way as inserting a column by either using **Edit > Insert** on the Menu bar, the **Insert** button on the Edit toolbar or the **Insert** keyboard function key. Place the Edit cursor on the rung where the row is to be inserted and use one of the above methods to perform the insertion. Make the appropriate selections on the dialog and press **OK**. A row will appear for the instruction to be added.

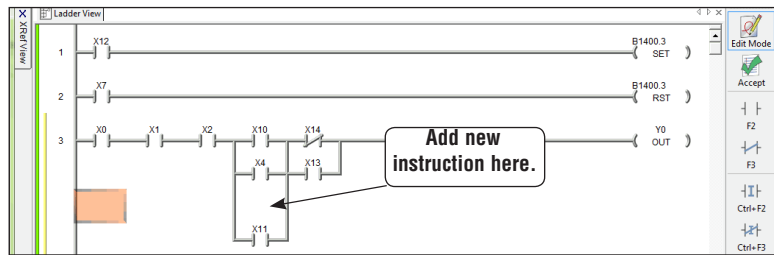
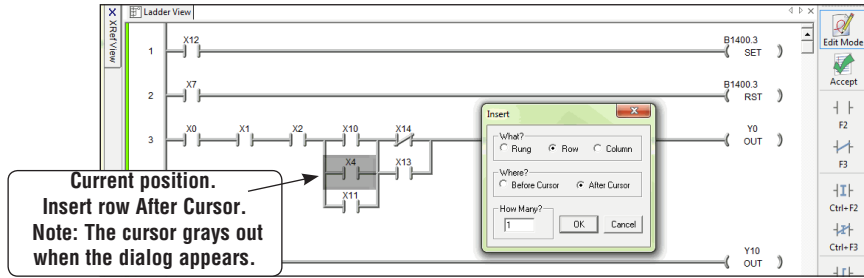

Inserting a rung is done in the same manner as inserting a row, except select Rung in the Insert dialog. A new blank rung is inserted either above or below the Edit cursor position.

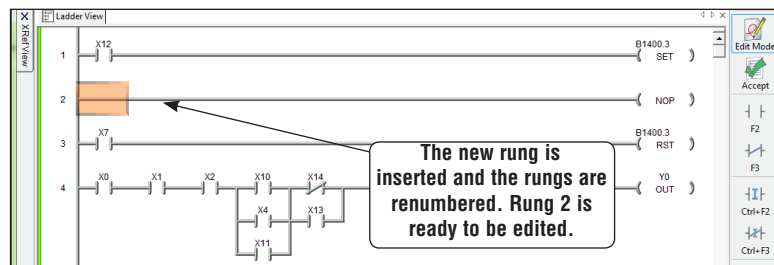

## Using Search and Replace



A very useful tool in *DirectSOFT6* is the replace feature. Replace is used to replace one element reference with the reference of another element. To access this tool, use one of the following procedures: **Search > Replace** on the Menu bar, **Ctrl + R** Hot Key or the **Replace** button on the Search toolbar. The **Replace** dialog will appear, as shown below, which will allow you to define the search and replace procedure.

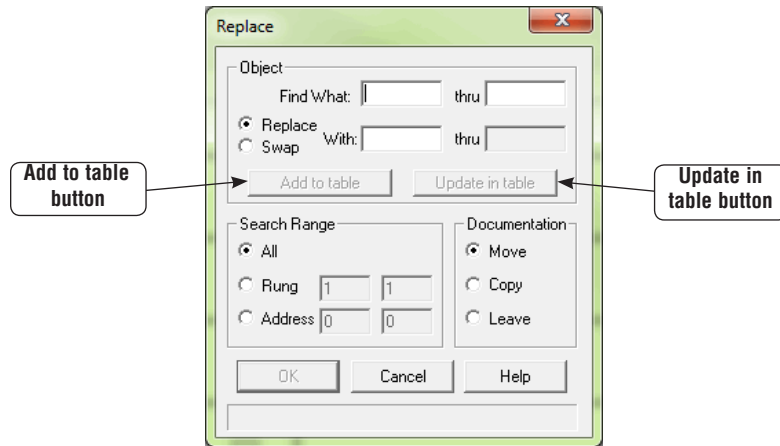

### Using the Object Section

Begin by entering an element reference in the **Find what:** field. Enter an element reference in the **thru** field if there is a range of references to replace. Leave this field blank if only one reference is involved. Select whichever procedure is to be performed, either **Replace** or **Swap**. Choose replace to perform the replace function. For example, X1 to X12. Choose swap to swap the element references from one element to another. For example, X1 is swapped with X12 so X12 is now the former X1 element and X1 is the former X12 element. Next, enter the element reference to be replaced or swapped with in the **With:** field. The **thru** field is read only and will be filled in as the replacement reference is entered. The **Add to table** button is used to add the current object to the table which is used to perform multiple replacements at one time (See the diagram on the following page). The **Update in table** button is pressed if an object within the table needs to be edited. This allows the replacement of the object in the table with the newly edited object.

### The Search Range Section

There are three range selections for the replace procedure:

1. **All** – will select the entire program as the replacement range.
2. **Rung** – will allow a certain range of rungs to be setup to perform the replacement.
3. **Address** – will allow a range of addresses to be entered (addresses to be converted to rung boundaries) to perform the replacement.

### The Document Section

There are three ways to handle the documentation whenever elements are replaced or swapped:

1. **Move** – selecting this will move the documentation from the source element to the destination element.
2. **Copy** – this selection will copy the documentation from the source element to the destination element.
3. **Leave** – this will leave the documentation at the source element.

### The Object Table Section

The Object table shows all objects which have been added to the table of replacements. To update an object, selecting it from the table will place the object in the Object section so it can be edited.

Use the **Delete from table** button to delete an entry from the Object table. Press **OK** once all of the selections have been made on the dialog.

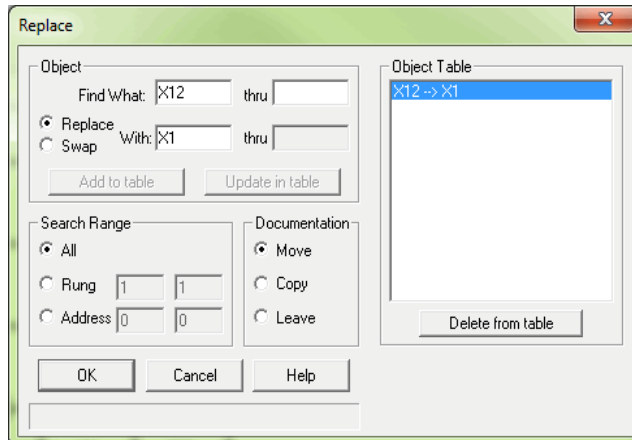

## Common Mistakes

It is not uncommon to make programming errors. The fewer errors made, the quicker a program can be completed. Here are some of the more common errors.

### Failure to Enter the Edit Mode

Some new users will typically open a project and immediately try to edit a program. **Remember that you must enter the Edit Mode.** Entering the Edit Mode can be done in several ways. Use either **Edit > Edit Mode**, **Ctrl + E** or press the **EDIT MODE** button located on the Offline toolbar and on the Ladder palette. When in the Edit Mode, the cursor box will turn a solid color.

### AND above a Join

The rule is that after a wire has been drawn down on a rung of logic to “AND” a sub-rung that contains a midline output, no additional input logic may appear on the leg of the midline output.

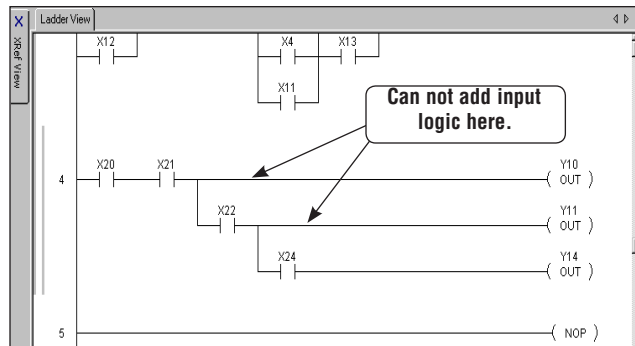

### Forgetting to Select Rungs

In order to **Cut** or **Copy** a rung or rungs, the rungs *must be selected* (use **Shift + up or down arrows**). If nothing is selected, the Cut and Copy buttons will be grayed out on the Offline toolbar and on the Menu bar.

# DOCUMENTATION

---



## In This Chapter...

Turn Documentation On and Off.....	6-2
Using the Documentation Editor.....	6-4
Documenting and Assigning Nicknames.....	6-6
Entering Rung Comments.....	6-9
Entering Stage Comments.....	6-12
Importing and Exporting.....	6-14
Prevent Documentation Loss.....	6-28



## Turn Documentation On and Off

Documentation is the text associated with the components and structure of a *DirectSOFT6* program which is added for greater clarity. It may refer to the elements, wiring, rungs or stages. All documentation options are turned ON by default when the **Options** dialog is first opened.

### The Options Dialog

*DirectSOFT6* allows the programmer to turn ON/OFF the documentation in each available view. A quick way to open the Options dialog is to place the mouse cursor in the displayed view and right click the mouse. A pop-up window will appear with Options as one of the selections. Select Options and the dialog will appear like the one shown below. When the dialog opens, the Ladder tab is in view by default. The other views can be selected by clicking on the tab at the top of the dialog.

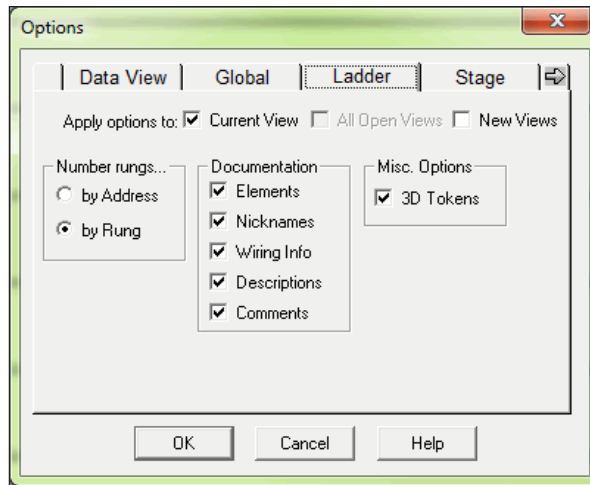

The Ladder tab is showing all of the documentation types checked. Leaving each selection checked turns ON that documentation type to be shown in the program. Unchecking the documentation type will turn it OFF in the program. Most of the Options dialog features have been discussed in Chapter 4. For turning the documentation ON/OFF, only the Ladder, Stage, XRef and Data View (under Doc tab) options need to be accessed.

## Documentation Selections

Most documentation refers to individual elements, therefore, it is specific in nature. Listed below are four types of documentation

- **Elements** – the references for the individual elements, i.e. X1, Y10, etc.
- **Nicknames** – these are alpha-numeric names that are used for the various types of program elements. It is usually easier to remember the name *Start Switch* than it is to remember that X1 is the input for the switch.
- **Descriptions** – detailed description of an element. This can also be used to add brief trouble-shooting steps, etc.
- **Wiring Info** – this can be used to identify panel wiring for the project.

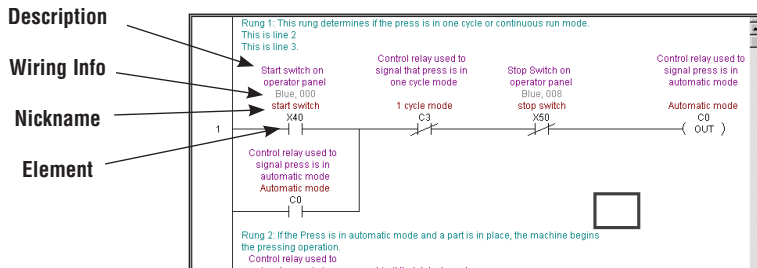

## General Documentation

Comments are general descriptions that are best suited for descriptions of a program rung, or a section of the program.

- **Rung Comments** – rung comments are assigned to an individual rung.
- **Stage Comments** – if you are using the Stage instructions, you can also add comments that describe the contents of any stage.

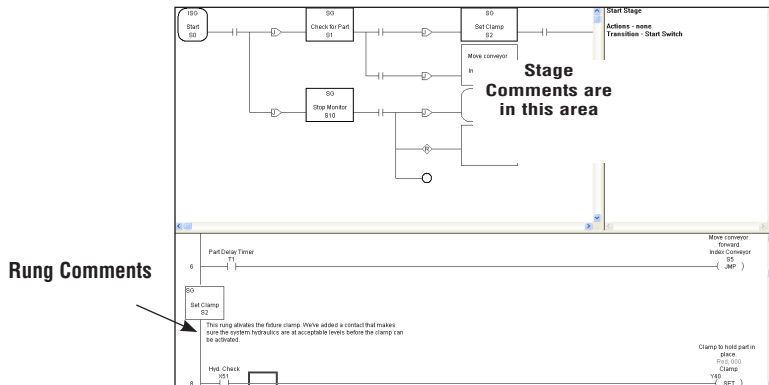

## Using the Documentation Editor

Nicknames, wiring information and descriptions for program elements are entered using the Documentation Editor. The editor can be accessed using **Tools > Documentation Editor** on the Menu bar, **Ctrl + D** or by pressing the Documentation button on the Tools toolbar.

The screenshot shows the 'Documentation Editor' window with a toolbar at the top containing navigation buttons (left arrow, R, left double arrow, left arrow, right arrow, right double arrow, R, right arrow, home, end) and a table below. The table has four columns: Element, Nickname, Wiring Info, and Description. It lists elements X40 through X47 with their respective nicknames, wiring information, and descriptions.

Element	Nickname	Wiring Info	Description
X40	Start Switch	Blue, 000	Start Switch on operator panel.
X41	Part Present	Blue, 001	Limit that detects part in fixture
X42	Clamp Locked	Blue, 002	Confirms that clamp has securely locked the part in place.
X43	Clamp Unlocked	Blue, 003	Confirms that the clamp is unlocked.
X44	Lower Limit	Blue, 004	Lower arbor limit. Part has been pressed.
X45	Upper Limit	Blue, 005	Upper arbor limit.
X46	Conveyor Confirm	Blue, 006	Confirms that conveyor actually traveled forward.
X47	One Cycle Switch	Blue, 007	Switch on operator panel selects one-cycle or automatic operation.

### Using the Scroll Buttons

There are scroll command buttons (arrowheads) located at the top of the editor. They are shown (both directions) as ►, ►►, ►R, ►|, etc. Each button has a unique function:

- – Moves one element forward.
- – Moves one page forward.
- R – Moves to the beginning of the next data type (X, Y, C, etc.)
- | – Moves to the last document type.
- ◄ – Moves one element back.
- ◄◄ – Moves one page back.
- R◄ – Move to the beginning of the previous data type.
- |◄ – Moves to the beginning of the first document point.

## Copying Documentation Between Elements

If it becomes necessary to use the Documentation editor, all of the familiar Windows keyboard shortcuts (copy, cut, paste, etc.) can be used within the editor. For example, if there is a lengthy description for a point, and other points are similar, the information can be copied. The following example will demonstrate how this is accomplished.

1. Position the cursor in the cell to be copied.
2. Double click to highlight the information.
3. Press **Ctrl + C** to copy the information in the cell.
4. Move the cursor to the element cell where the information is to be copied to. (Use the **Find** button, **Ctrl + F** shortcut or scroll).
5. With the cursor in position to paste the information, press **Ctrl + V**.

Element	Nickname	Wiring Info	Description
X40	Start Switch	Blue, 000	Start Switch on operator panel.
X41	Part Present	Blue, 001	Limit that detects part in fixture
X42	Clamp Locked	Blue, 002	Confirms that clamp has securely locked the part in place.
X43	Clamp Unlocked	Blue, 003	Confirms that the clamp is unlocked.
X44	Lower Limit	Blue, 004	Lower arbor limit. Part has been pressed.
X45	Upper Limit	Blue, 005	Upper arbor limit.
X46	Conveyor Confirm	Blue, 006	Confirms that conveyor actually traveled forward.
X47	One Cycle Switch	Blue, 007	Switch on operator panel selects one-cycle or automatic operation.



**NOTE:** When copying a nickname, the new nickname will have a “?” before and after the newly pasted entry. This occurs because each nickname must be unique.

# Documenting and Assigning Nicknames

## Create an Unassigned Nickname

Element nicknames are used more often than any other type of documentation. As a program is developed using nicknames, element references do not have to be entered when a contact, coil, etc. is entered. Wiring information and descriptions can also be entered without knowing the actual element reference.

Unassigned nickname is entered (red indicator remains on).

The nickname is accepted without being linked to an element.

Click OK

Dialog appears when a nickname is entered without being linked to an element.

## Assign the Nickname to an Element



If unassigned nicknames have been created in the program, element references must be assigned before the program can be written to the PLC (the PLC does not recognize nicknames, only element references). The **Assign Nicknames** dialog is used to assign nicknames to element references. A quick way to open the dialog is to either press **F9** (hotkey) or the **Assign Nicknames** button (if the Tools toolbar is displayed). Another way is to use **Tools > Assign Nicknames** from the Menu bar. Also, if the **Element Browser** is open, nickname information can be assigned by clicking on the **Assign Nicknames** button in the Element Browser and the Assign Nicknames dialog will appear as shown on the facing page.



**Tip:** Nicknames can be compiled and saved to disk; and then assigned later, just before downloading to the PLC.

## Open the Element Browser

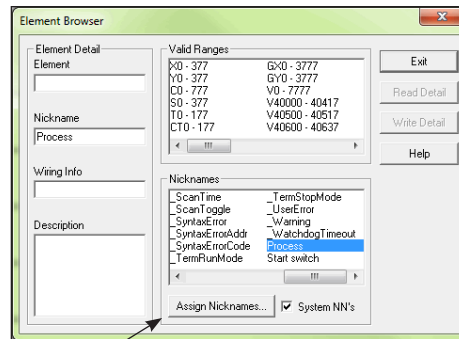

Click here to open the Assign Nicknames dialog.

The **Assign Nickname** dialog will appear with the list of unassigned nicknames appearing in the **Source Nickname** column. Select the nickname in the list and enter the element reference for the nickname in the **Source Element** Column.

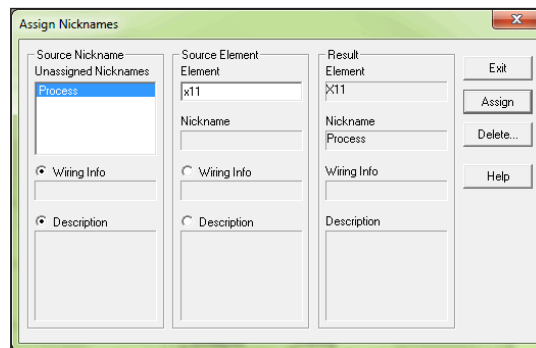

The reference will be duplicated in the **Result** column to help avoid accidental entries. Press **Assign** and the following dialog will appear as a confirmation of the element entry.

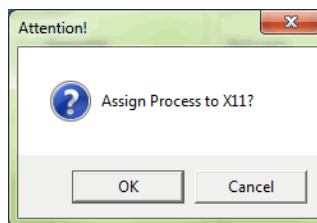

If the reference entered is correct, click **OK**. The Element Browser will be in view again so that wiring information and a description, if any, can be added. Pressing **Exit** will close the browser and the program will have the new element in the program as shown below.

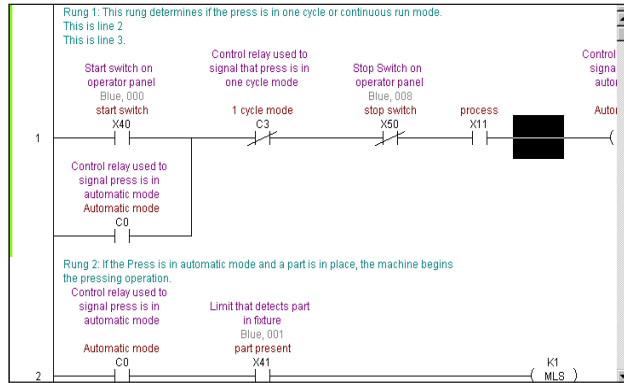

## Entering Rung Comments



Each rung in a *DirectSOFT6* program can have associated comments. Unlike some programming packages from other vendors, the comments are not tied to the outputs. Instead, the comments remain with the rung where the comments are added regardless if other rungs are deleted before a commented rung. To edit a comment, the cursor must be on the rung to where it is to be added. Now, either press the keyboard shortcut **Ctrl + K**, **Tools > Comment Editor** on the Menu bar or press the **Comments** button on the Tools toolbar if it is displayed. The **Edit Comments** dialog, shown below, will appear.

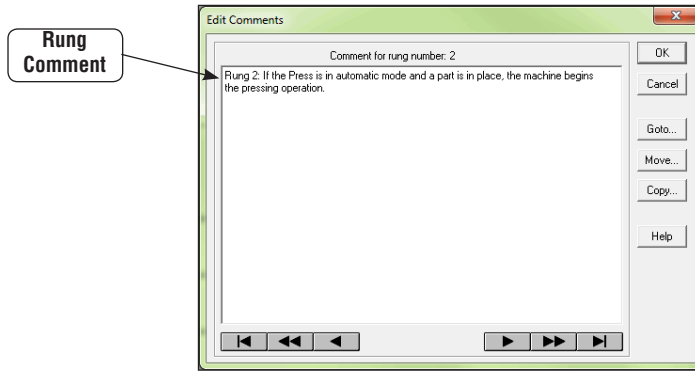

### Comments are Free-form

The appropriate comment can be added as necessary. The Ladder view is a full screen editor, therefore, backspacing the entire comment is not necessary to fix a spelling error. Instead, position the cursor over the word to be edited and double-click the left mouse button to highlight the word, then type in the corrected word.

### Selecting Rungs for Comments

Once you have edited a rung comment you can use the **Page Up** and the **Page Down** keyboard buttons to scroll to another rung comment to edit. A specific rung can be found by using the **Goto** button on the editor dialog.



### Using the Scroll Buttons

There are scroll command button (arrowheads) located at the bottom of the dialog. They are shown for both directions as ►, ►►, ►|, etc. Each button performs a different function:

- – Moves to the next rung comment.
- – Moves ahead five rung comments.
- | – Moves to the comment for the last rung.
- ◄ – Moves to the previous rung comment.
- ◄◄ – Moves back five rung comments.
- |◄ – Moves to the comment for the first rung.

Click on the **OK** button after entering the rung comments.

### Use the Editing Keys

The keyboard shortcut keys can be used to copy, cut and paste comments between rungs.

1. Position the cursor at the beginning of the text to be copied or cut.
2. Press and hold the left mouse button and move the cursor to highlight the text, then release the button. The **Shift + Arrow** keys can also be used to highlight the text.
3. Use the **Ctrl + C** keys to copy the text or the **Ctrl + X** keys to cut the text.
4. Locate the rung where the information is to be pasted (Use **Previous**, **Next** or **Goto**).
5. Position the cursor where the text is to be pasted and click the left mouse button, then press **Ctrl + V** to paste the text.
6. The **Delete** key can also be used to delete text.

## Move Rung Comments

Rung comments can easily be moved from one rung to another with **DirectSOFT6**. This feature is useful after one or more rungs have been inserted by a handheld programmer or by another computer which did not have the documentation files available. The Move comment feature can be used to match the comment(s) with the correct rung(s). Comments can be moved for a single rung or a group of rungs. To move comments, click on the **Move** button on the dialog. The window will appear within the dialog.

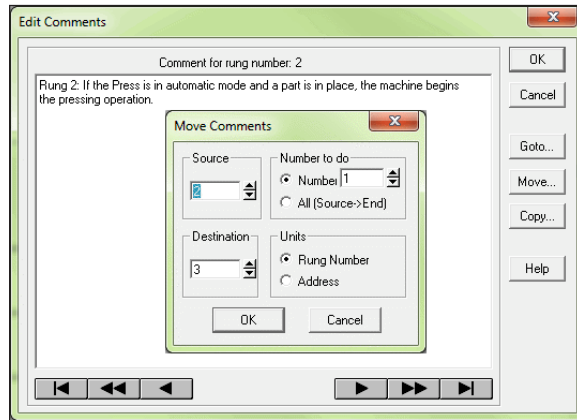

Fill in the appropriate fields to specify the source and destination for moving a comment.

- **Source** – This is the beginning of the group of comments to be moved. Enter the rung number (or address) of the rung with the comments to move.
- **Destination** – Enter the rung number (or address) of the rung to move the comments to.
- **Number to Move** – Chose **All** or enter the number of comments to move from the source to the destination.
- **Units** – Select either **Rung Number** or **Address**.

Press **OK** to complete the move or **Cancel** to exit without performing the operation.

**NOTE:** You can overwrite existing rung comments with this feature. **DirectSOFT6** always provides a confirmation prompt before it completes the move. The message reminds you that any overlapping comments will be changed. This message will appear even if there are no overlapping rungs. It is a reminder that existing rungs can be overwritten.



## Entering Stage Comments

### Use Stage View

If you are using Stage instructions, comments can be entered for each stage. The Stage View must be displayed in order to enter the comments. With a Ladder View open, the Stage View is opened by clicking on **View > Stage View** on the Menu bar.

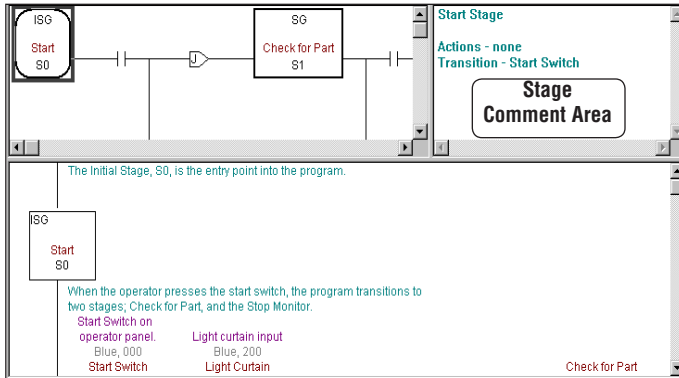

In order to enter Stage comments, the cursor must be positioned in either of the upper quadrants of the Stage view. To open the comment editor, either click on the keyboard shortcut **Ctrl + K, Tools > Comment Editor** on the Menu bar or press the **Comments** button on the Tools toolbar if it is displayed. The Comment editor can also be opened by double-clicking the left mouse button with the cursor positioned in the stage comment area. Note that the comment editor is for Stage comments.

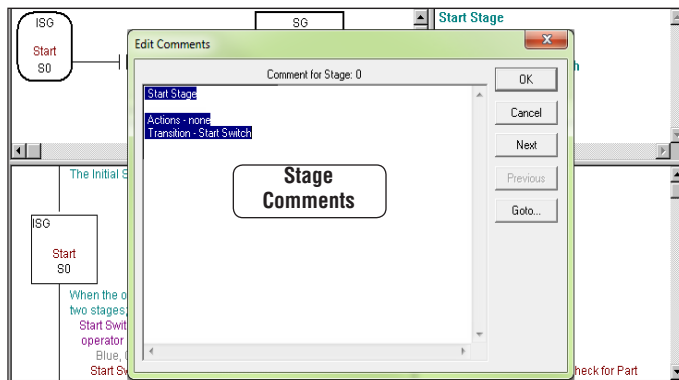

## Comments are Free-form

A new comment can be edited immediately. The appropriate comment can be added as necessary.

## Selecting Stages to Comment

Once you have edited a rung comment you can use the **Page Up** and the **Page Down** keyboard buttons to scroll through the Stages. A specific Stage can be found by using the **Goto** button on the editor dialog. After the comments have been entered, press the **OK** button to save the comments and close the editor.

## Editing the Comments

The keyboard shortcut keys can be used to copy, cut and paste comments between stages.

1. Position the cursor at the beginning of the text to be copied or cut.
2. Press and hold the left mouse button and move the cursor to highlight the text, then release the button. The **Shift + Arrow** keys can also be used to highlight the text.
3. Use the **Ctrl + C** keys to copy the text or the **Ctrl + X** keys to cut the text.
4. Locate the stage where the information is to be pasted (Use **Previous**, **Next** or **Goto**).
5. Position the cursor where the text is to be pasted and click the left mouse button, then press **Ctrl + V** to paste the text.
6. The **Delete** key can also be used to delete text.



---

**NOTE:** All documentation edits are written to the documentation files when they are entered/edited.

---

## Importing and Exporting

*DirectSOFT6* can import and export ladder programs, element documentation (nicknames, wiring info and descriptions) and rung comments from a project. The Import/Export data is expected to be in CSV format (comma-separated variables) which is a popular import/export text format for applications like Microsoft Excel and AutoCAD. For example, Microsoft Excel can be used to generate an element documentation file to be imported directly into a *DirectSOFT6* project. The existing element documentation can be exported to a CSV file that can be used in diagrams in an AutoCAD program.

### Exporting Program Documentation

The project must be open in order to export program documentation. Three export options are available to choose from, Program, Element Documentation and Rung Comments. The following steps will show how to export a program. There are two ways to export a program, either select **File > Export > Program** from the Menu bar or select the **Export** button on the File toolbar if it is displayed. Either method used will open the **Export Program** dialog shown on the facing page.

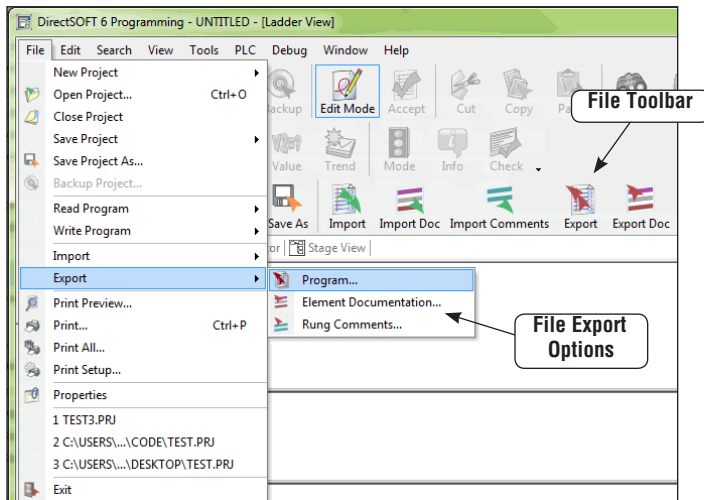

In the Export Program dialog, select where the program is to be exported to, enter the program name and click the **Save** button.

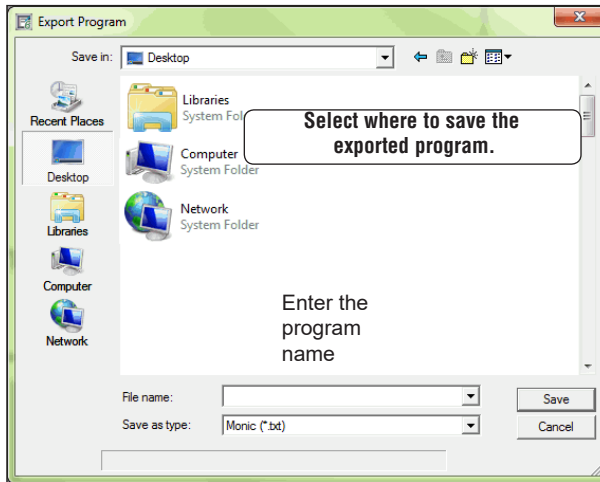

The following dialog will appear so options can be selected and saved. Click the **OK** button to save the program to a text file.

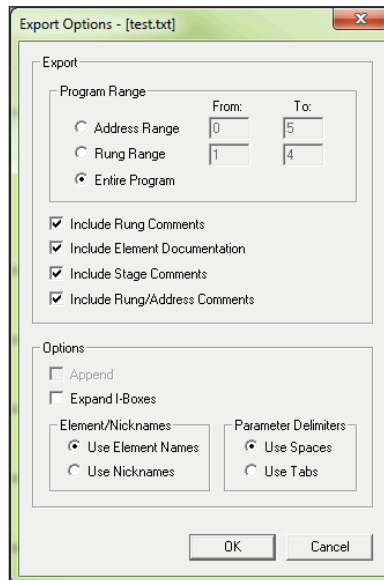

The text file can be opened with Notepad or equivalent word processor. The Notepad example below shows what can be exported. Note the Rung Comments and the Element Documentation.

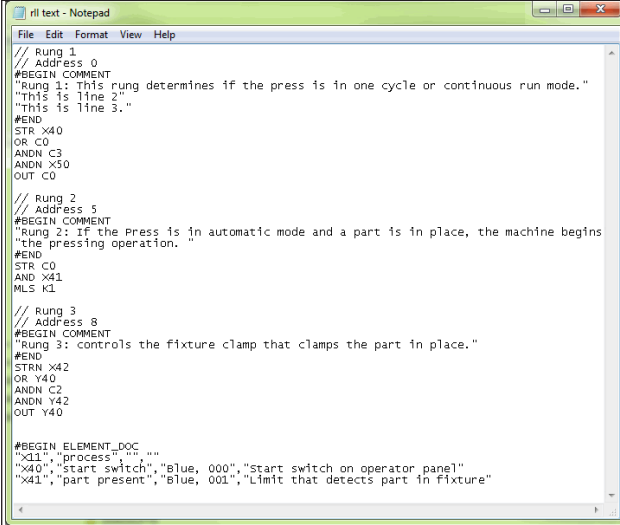

```
File Edit Format View Help
// Rung 1
// Address 0
#BEGIN COMMENT
"Rung 1: This rung determines if the press is in one cycle or continuous run mode."
"This is line 2."
"This is line 3."
#END
STR X40
OR C0
ANDN C3
ANDN X50
OUT C0

// Rung 2
// Address 5
#BEGIN COMMENT
"Rung 2: If the Press is in automatic mode and a part is in place, the machine begins
the pressing operation."
#END
STR C0
AND X41
MLS K1

// Rung 3
// Address 8
#BEGIN COMMENT
"Rung 3: controls the fixture clamp that clamps the part in place."
#END
STRN X42
OR Y40
ANDN C2
ANDN Y42
OUT Y40

#BEGIN_ELEMENT_DOC
"x11", "process", "P", ""
"x40", "start switch", "Blue, 000", "start switch on operator panel"
"x41", "part present", "Blue, 001", "Limit that detects part in fixture"
```

### Export Element Documentation

Element information can be exported from a project to a .csv file. The following illustrations will show the steps to use to export the documentation. Press the Export Element Documentation button on the File toolbar or select **File > Export > Element Documentation** to export the documentation.

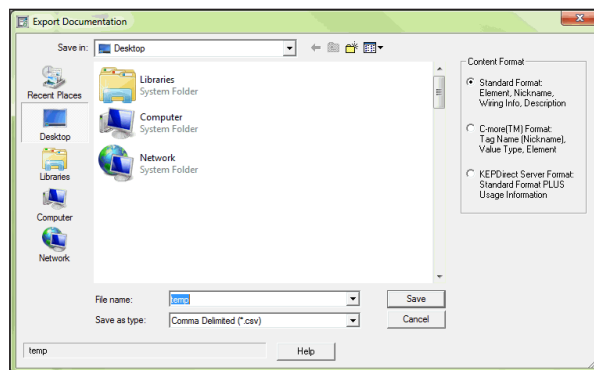

There are three different formats to select from to export. Standard, C-more and KEPDirect Server formats. All formats generate a .csv file in spreadsheet form.

This is a standard format showing an Excel spreadsheet with the element reference in column A, the nickname in column B, wiring information in column C and description in column D.

A1	A	B	C	D	E	F	G	H	I	J
1	X40	start switc	Blue, 000	Start switch on operator panel						
2	X41	part preser	Blue, 001	Limit that detects part in fixture						
3	X42	part locker	Blue, 002	Confirms that the clamp is locked						
4	X43	part unlock	Blue, 003	Confirms that the clamp is unlocked						
5	X44	lower limit	Blue, 004	Lower arbor limit.						
6	X45	upper limit	Blue, 005	Upper arbor limit						
7	X46	index conv	Blue, 006	Confirms that the conveyor actually moved forward						
8	X47	one cycle	Blue, 007	Switch on operator panel selects one cycle or automatic operation						
9	X50	stop switc	Blue, 008	Stop Switch on operator panel						
10	Y40	clamp	Red, 000	Clamp to hold part in place						
11	Y41	arbor down	Red, 001	Output for downward movement of the arbor						
12	Y42	conveyor	Red, 002	Motor starter for conveyor motor						
13	C0	Automatic mode		Control relay used to signal press is in automatic mode						
14	C1	press complete		Control relay showing that the part has been pressed						
15	C2	release clamp		Control relay that controls the releasing of the fixture clamp						
16	C3	1 cycle mode		Control relay used to signal that press is in one cycle mode						
17	T0	Conveyor delay		Delay timer for conveyor						
18	CT0	Part Counter		Self resetting parts counter to count number of parts made						
19										
20										

The illustration below is the C-more format showing an Excel spreadsheet with the tagname (element) in column C, the data type in column D and element reference (Address) in column G.

A	B	C	D	E	F	G
1	ProtocolID	DeviceName	TagName	DataType	DataCount	Retentive
2	100	DEV001	PUMP NO. 2 START PB	Discrete	1	FALSE
3	100	DEV001	PUMP NO. 1 START PB	Discrete	1	FALSE
4	100	DEV001	PUMP NO. 1 STOP PB	Discrete	1	FALSE
5	100	DEV001	PUMP NO. 2 STOP PB	Discrete	1	FALSE
6	100	DEV001	SOUTH STATION CONTROL OPENED	Discrete	1	FALSE
7	100	DEV001	SOUTH STATION CONTROL CLOSDSED	Discrete	1	FALSE
8	100	DEV001	NORTH STATION CONTROL OPENED	Discrete	1	FALSE
9	100	DEV001	NORTH STATION CONTROL CLOSDSED	Discrete	1	FALSE
10	100	DEV001	PUMP NO. 1 AUTO	Discrete	1	FALSE
11	100	DEV001	PUMP NO. 2 AUTO	Discrete	1	FALSE
12	100	DEV001	PUMP NO. 1 SPEED - RPM	Signed_int_16	1	FALSE
13	100	DEV001	PUMP NO. 2 SPEED - RPM	Signed_int_16	1	FALSE
14	100	DEV001	FLOW RATE - GPM	BCD_int_16	1	FALSE
15						
16						
17						
18						
19						
20						

**NOTE:** If unassigned nicknames are exported, they will appear in the resultant text as the following types:



UB - unassigned bit

UBY - unassigned byte (useful only for R memory in the DL305)

UW - unassigned word

UDW - unassigned double-word

UU - unassigned unknown (used for uninitialized types, should never be used)



### Export Rung Comments

The program rung comments can be exported from a project to a text file and a printout can be obtained using Microsoft Notepad or equivalent word processor. The following dialog will appear when either pressing the **Export Comments** button on the File toolbar if it is displayed or by pressing **File > Export > Rung Comments**. Select where the file is to be saved, then name the text file and press the **Save** button.

The illustration below is an example of an exported comment text file shown with Microsoft Notepad.

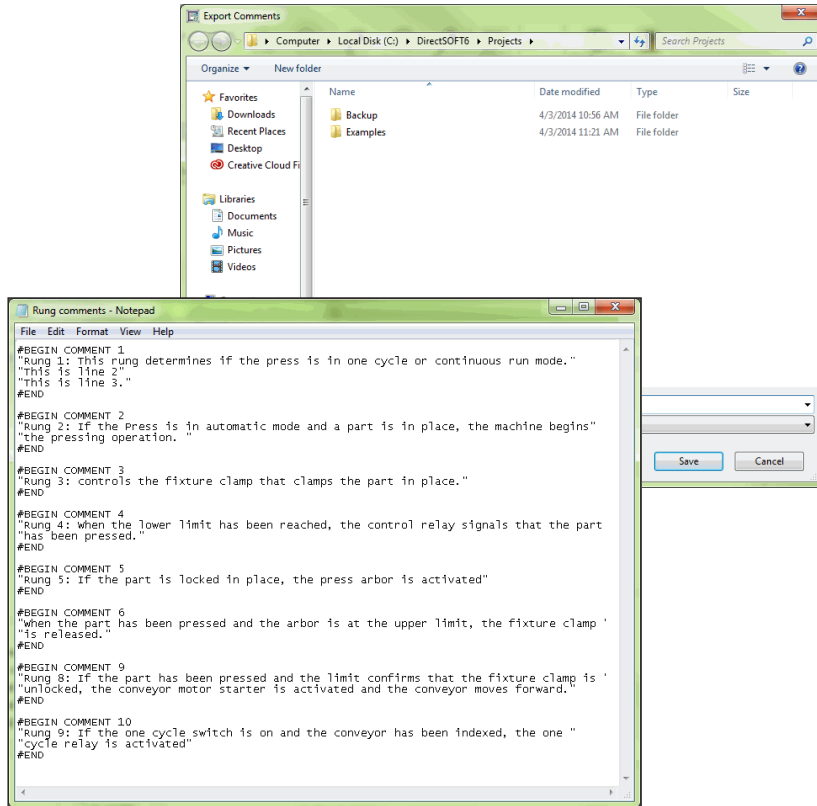

## Importing a Program

There may be a time when it is necessary to import a *DirectSOFT6* program which has been previously edited and exported as a text file. This could be an entire program or just a few rungs with element nicknames and comments. Use the following illustrated steps to guide you through the import procedure.

Begin by opening the New Project dialog from the *DirectSOFT6* Launch window (page 3-4). Cancel the New Project dialog, then either select **File > Import > Program** or press the **Import** button on the File toolbar if it is displayed.

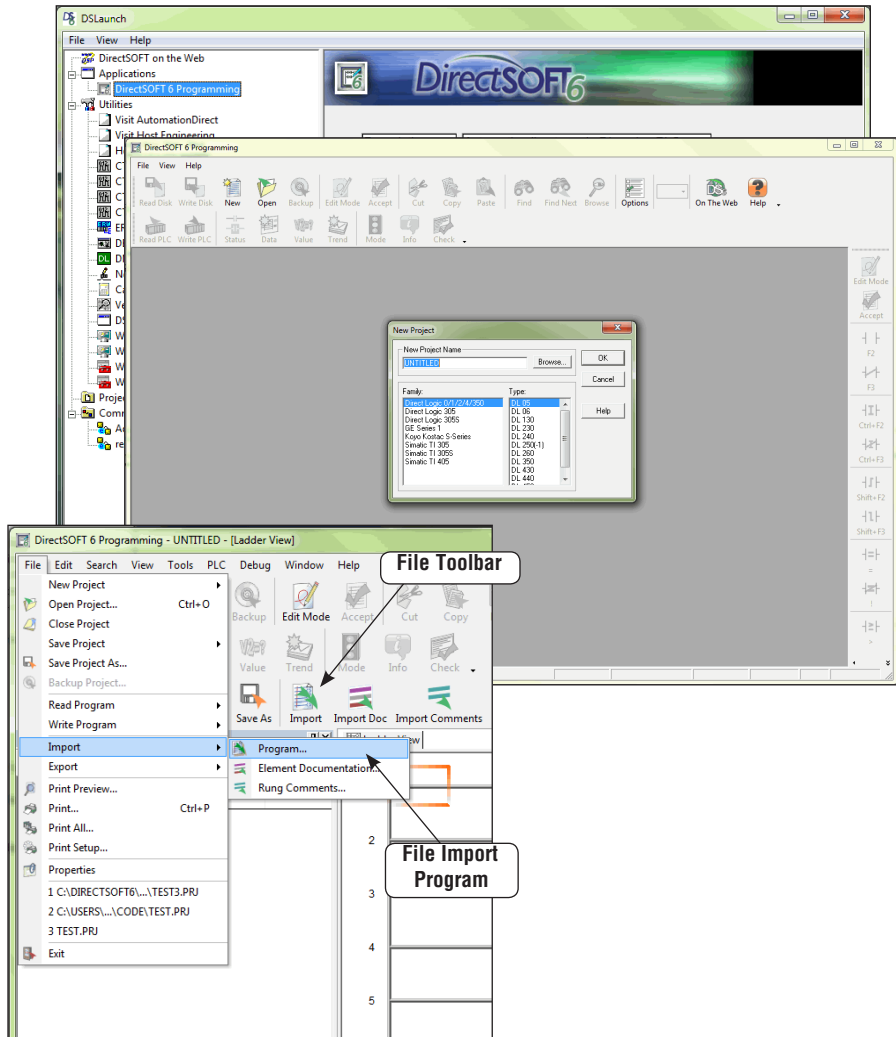

The **Import Program** dialog will appear so the program text to be imported can be selected. Select a previously exported *DirectSOFT6* program to import. Choose the program text file and click **Open**.

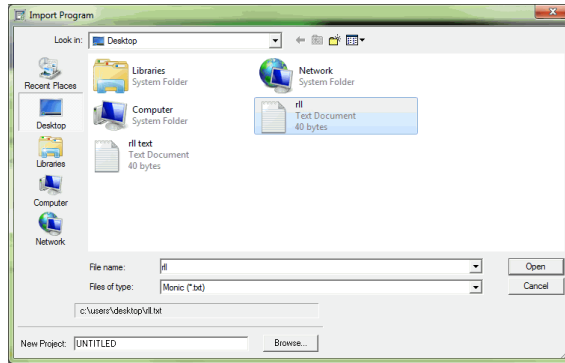

The complete imported program will appear as shown below. In this example, all elements, element descriptions, nicknames and rung comments appear in the program along with the cross reference.

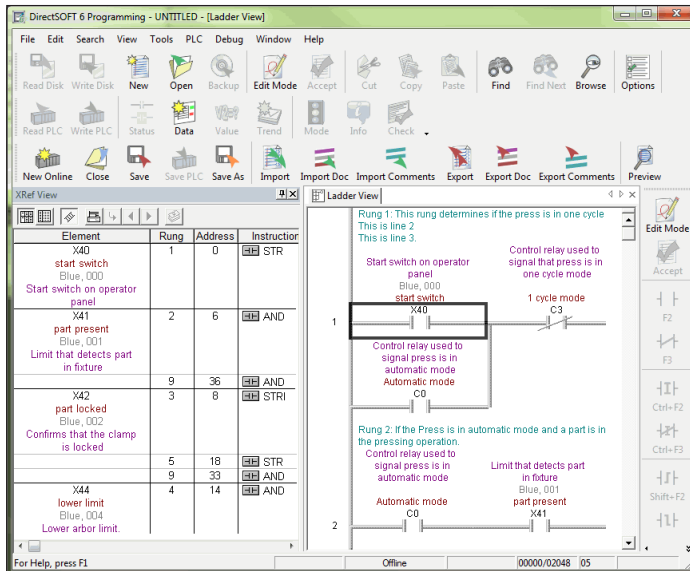

Element	Rung	Address	Instruction
Y40 start switch Blue, 000 Start switch on operator panel	1	0	STR
Y41 part present Blue, 001 Limit that detects part in fixture	2	6	AND
Y42 part locked Blue, 002 Confirms that the clamp is locked	9	36	AND
Y44 lower limit Blue, 004 Lower arbor limit.	4	14	AND
	5	19	STR
	9	33	AND

**Rung 1:** This rung determines if the press is in one cycle  
This is line 2  
This is line 3.  
Start switch on operator panel  
Control relay used to signal that press is in one cycle mode  
1 cycle mode C3

**Rung 2:** If the Press is in automatic mode and a part is in the pressing operation.  
Control relay used to signal press is in automatic mode  
Automatic mode C0  
Limit that detects part in fixture Blue, 001  
part present Y41

Exported programs, element documentation and rung comments can be imported using the *DirectSOFT6* programming window if it has been opened to edit another program. This is done by first saving and closing the current program. Next, either select **File > Import > Program** or press the **Import** button on the File toolbar. The program to be imported is selected and opened as shown in the previous example.

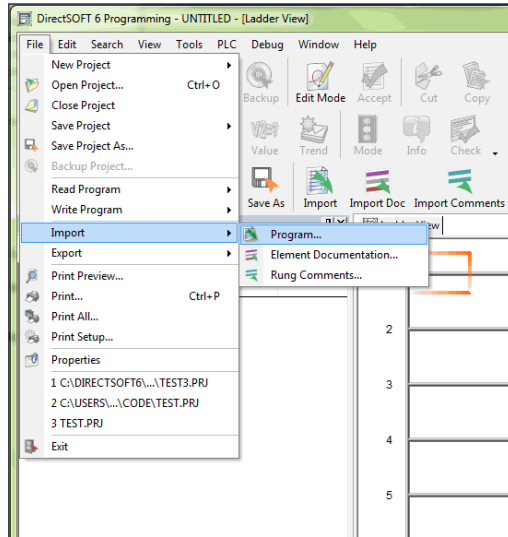

## Importing Element Documentation

To import program documentation, a project must be open. This project can be the one currently open. The typical method for importing element documentation is to import a .csv file which has been previously exported. It is possible to generate element documentation using a spreadsheet such as Microsoft Excel, but it is important to follow the correct import format. The standard format is in spreadsheet form which should be setup in columns similar to the example below: element reference in column A, the nickname in column B, wiring information in column C and element descriptions in column D.

	A	B	C	D	E	F	G	H	I	J	K
1	X40	start switc	Blue, 000	Start switch on operator panel							
2	X41	part preset	Blue, 001	Limit that detects part in fixture							
3	X42	part locker	Blue, 002	Confirms that the clamp is locked							
4	X43	part unlock	Blue, 003	Confirms that the clamp is unlocked							
5	X44	lower limit	Blue, 004	Lower arbor limit.							
6	X45	upper limit	Blue, 005	Upper arbor limit							
7	X46	index conv	Blue, 006	Confirms that the conveyor actually moved forward							
8	X47	one cycle	Blue, 007	Switch on operator panel selects one cycle or automatic operation							
9	X50	stop switc	Blue, 008	Stop Switch on operator panel							
10	Y40	clamp	Red, 000	Clamp to hold part in place							
11	Y41	arbor down	Red, 001	Output for downward movement of the arbor							
12	Y42	conveyor	Red, 002	Motor starter for conveyor motor							
13	C0	Automatic mode		Control relay used to signal press is in automatic mode							
14	C1	press complete		Control relay showing that the part has been pressed							
15	C2	release clamp		Control relay that controls the releasing of the fixture clamp							
16	C3	1 cycle mode		Control relay used to signal that press is in one cycle mode							
17	T0	Conveyor delay		Delay timer for conveyor							
18	CT0	Part Counter		Self resetting parts counter to count number of parts made							
19											

To import element documentation, select **File > Import > Element Documentation** or press the **Import Doc** button on the File toolbar. The window shown here will appear. Select the folder and the .csv file to be imported. Notice the **Import Method** box located on the right side of the window.

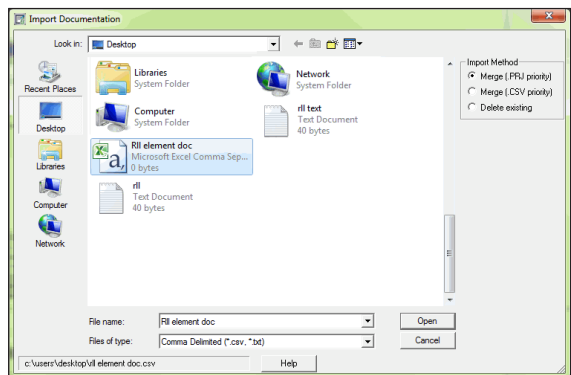

There are three import methods to select: **Merge (.PRJ priority)**, **Merge (.CSV priority)** and **Delete existing**. Selecting one of the three methods will determine the course of action which will be taken if the currently open project and the imported file have duplicate nicknames.

- If **.PRJ priority** is selected, the nicknames in the imported file will be added to the project file. If there are duplicates, the nickname in the project file will be kept.
- If **.CSV priority** is selected, the nicknames will be added to the project file. If there are duplicate nicknames, the import file will overwrite the ones in the project file.
- If **Delete existing** is selected, all of the element documentation of the open project will be deleted, then it will be rebuilt with the contents of the .csv file.
- Press the **Open** button to execute the import.

---

**NOTE:** If the following element types are imported, they will appear in the **DirectSOFT6** documentation editor with “\_\_\_” under the element type column:



*UB - unassigned bit*

*UBY - unassigned byte (useful only for R memory in the DL305)*

*UW - unassigned word*

*UDW - unassigned double-word*

*UU - unassigned unknown (used for uninitialized types, should never be used)*

---

Once the element documentation is imported, the Documentation editor will be updated with the imported information. This can be verified by opening the Documentation editor from Tools on the Menu bar, the Documentation Editor button on the Tools toolbar if it is displayed or use **Ctrl + D**. When the elements are created or if they are already used in the program, the element will be updated with the new information.

## Importing Program Comments

Exported program comments are imported like the element documentation as described on the previous two pages. To do this, select **File > Import > Rung Comments** on the Menu bar or press the **Import Comments** button on the File toolbar. The following window will appear. Select the folder and the .txt file to be imported.

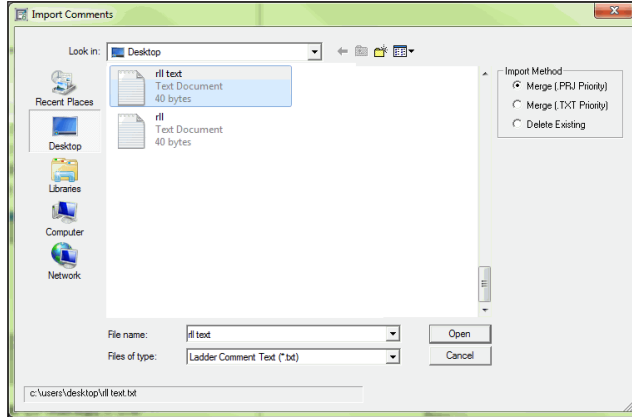

Also select the **Import Method** to use. **Merge (.PRJ priority)** if the current project is to remain in place when the import is executed. If comment matching occurs, a message will appear asking which one to update, the imported file or the existing file. Selecting **Merge (.TXT priority)** will allow the imported comments to overwrite the existing ones. **Delete Existing** will delete the current comments and update with the imported comments.

## Insert Instructions

The Insert Instructions From File feature will allow the insertion of mnemonic text files as instructions within an open project. Mnemonic instructions can be inserted one time or several times within a program. To use this feature, there must be an existing text file, such as, a file written with MS Notepad. This file must be written in mnemonic text form like the example on left. Note that rung comments, element descriptions, element nicknames and wiring information can be edited within the text file to be inserted.

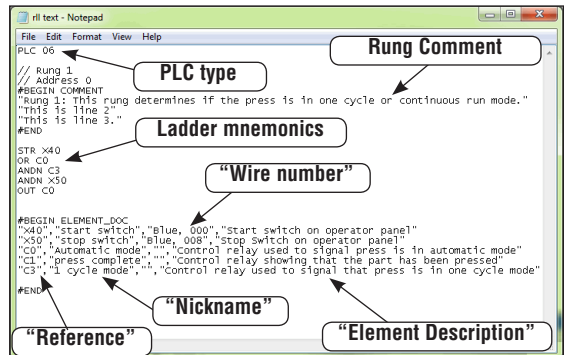

The text file needs to be edited in the same format as shown, with a PLC type at the beginning, #BEGIN, the documentation and #END. Quotation marks are placed around each line of rung comments. Of course, the ladder mnemonics are also edited with the text file. The element documentation must be in this form: “element reference”, “element nickname”, “wire number”, “description”. Quotation marks must be used with each entry followed by a comma. If an entry is to be left blank, the quotation marks *must not be omitted*.

The mnemonics text which is to be inserted can also be edited without comments like the example below. Note the PLC type is at the beginning of the text.

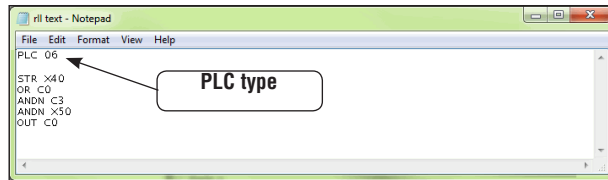

To insert the mnemonic text in a program being edited (Edit Mode), either use the **Tools > Insert Instructions From File** on the Menu bar or press the **Insert Instructions** button on the Tools menu if it is displayed.

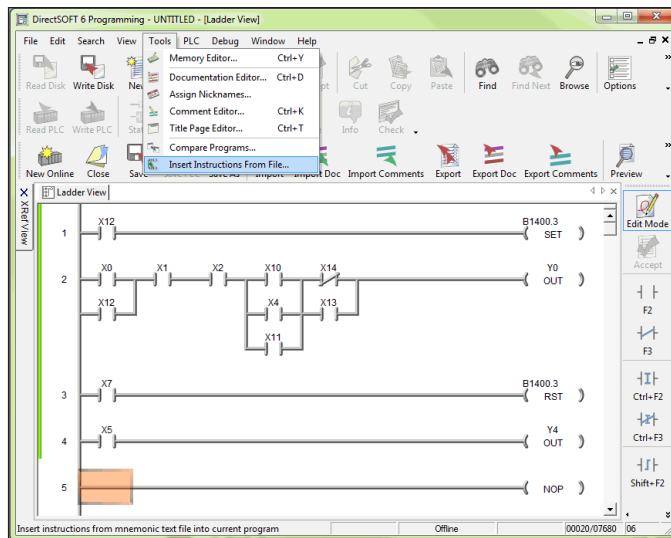



The **Insert Instructions** dialog will appear. Select the folder where the text file is located, then select the text file to be inserted. Next, choose either **Insert at Beginning**, **End** or **Before Rung Number**. How the element documentation can be imported involving “collisions” with existing program documentation can also be chosen. Select **Merge (.PRJ Priority)** if the existing project documentation is to remain unchanged. Select **Merge (.TXT Priority)** if the new documentation is to overwrite the existing documentation in the program. If the program element documentation is not to be changed, select **Ignore Element Documentation**. Press the **Open** button to execute the instruction.

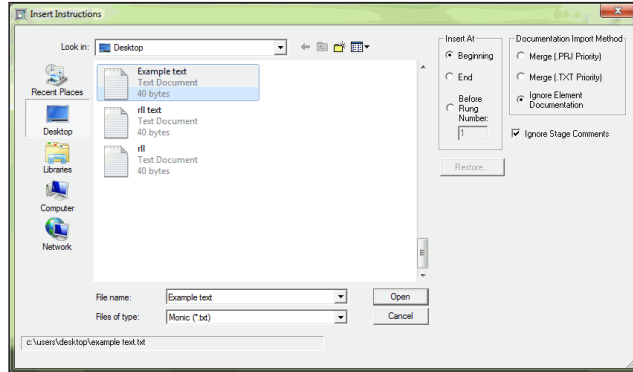

The **DirectSOFT6** Ladder view now displays the inserted instructions and documentation.

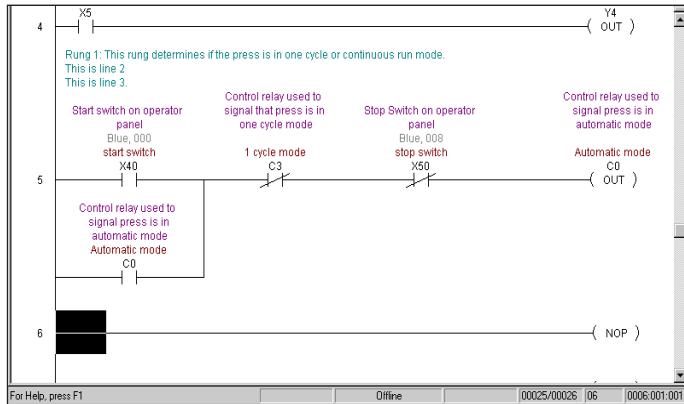

## Restore

One option which the Insert Instructions function has that can be useful is the **Restore** feature. Each time the Insert Instructions is executed, a backup copy of the entire program is made before the insert occurs. If an error is made, i.e. wrong code, just press the **Restore** button and the program will be restored to its original state.

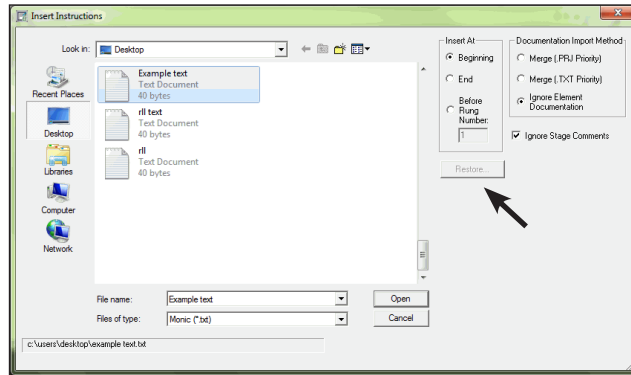

## Prevent Documentation Loss

The documentation which is created with *DirectSOFT6* is stored on disk. Each time a project is opened with *DirectSOFT6*, there are multiple project files opened. Apply the same precautions to your project as you would with any other database package to avoid data loss.

Backing up the project files is the best insurance to prevent loss. Any time changes are made to a project, make a copy of the project before starting. If something goes wrong, the original will remain intact and unchanged. There are four different methods to preserve a project as a program is created and after the project has been completed. The four methods are: Save Project (to disk), Save Project As, Backup Project and Export Program.

### Save Project

Save Project to Disk should be used to save your project often. Your entire project, i.e., program and all documentation will be saved to the drive that is being worked from, usually the C: drive. From the Menu bar, select **File > Save Project > to Disk** or press **Ctrl + S** (keyboard shortcut).

To save a project to a different folder than the one being worked from, select **File > Save Project As** from the Menu bar. The save as window will appear so the folder can be selected where the project is to be saved. Name the project, press the **Save** button and the entire project will be saved.

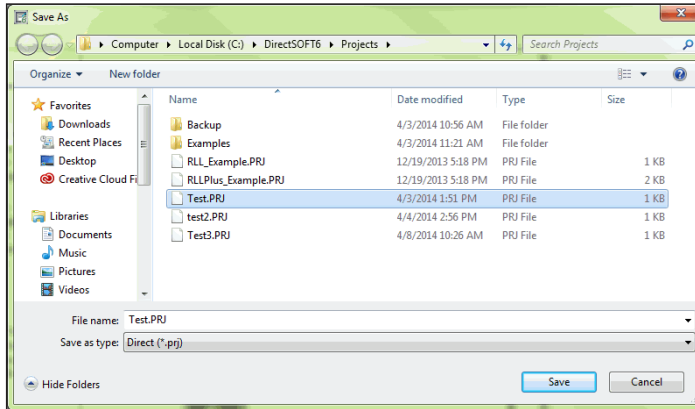

**NOTE:** The *Write to Disk* button on the *Offline* toolbar only saves the ladder logic program.



## Backup Project

The backup feature is another way to save your project. Selecting **File > Backup Project** on the Menu bar or pressing the **Backup** button on the Offline toolbar will open the following dialog asking if the project is to be saved. Press the **OK** button to save the project.

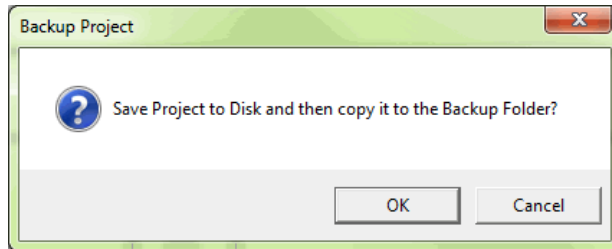

The following **Backup Project** dialog will appear, the project can be saved with the default date/time stamp or rename the folder. A different drive can also be selected to save the project.

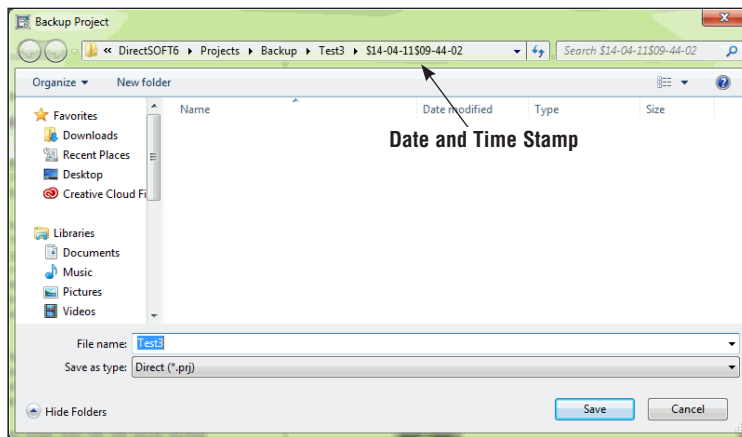

The last backup method is to use the export program feature as explained previously. This method will save a program to a text file. One advantage of the text file is that the program or comments can be edited without using *DirectSOFT6*.

Close all other applications that may be running to allow as much free RAM as possible. This not only lessens chances of memory conflicts, but also allows *DirectSOFT6* to run much faster.

Consider printing a hard copy of the program at longer intervals. If your computer breaks down or you lose all of the data due to a disk crash, you will at least have a hard copy of the program.

# OTHER VIEWS

---



## In This Chapter...

Tabbed Views.....	7-2
Stage (RLL <sup>PLUS</sup> ) View.....	7-4
Mnemonic View.....	7-5
Cross Reference (XRef) View.....	7-6
PID View.....	7-11
Trend View.....	7-13
Bookmark.....	7-17
View Terminology.....	7-18

## Tabbed Views

Using the Ladder View to create ladder logic programs has been discussed to this point. There are other views that are output only. These views will help to organize and better visualize the program. These additional views are Mnemonic, Stage (RLL<sup>PLUS</sup>), Cross Reference (XRef), Documentation Editor, Trend and PID Views. Once these views are opened, each view is easily accessed by a tab located at the top of the display window.

### The Primary Views

**Ladder, Stage, Mnemonics, XRef and Trend Views** are the primary views in *DirectSOFT 6*, and can be accessed by selecting the **View** submenu from the Menu bar and then selecting the view of your choice with the mouse cursor. When a new project is started, the Ladder and XRef Views appear as the default (refer to page 2-12). The Stage and Mnemonic Views can only be opened from the **View** submenu or by right-clicking when the mouse cursor is in any open View and selecting a different View from the Local Menu. The Trend View can be opened from the **View** submenu or from the Trend button on the Online Toolbar.

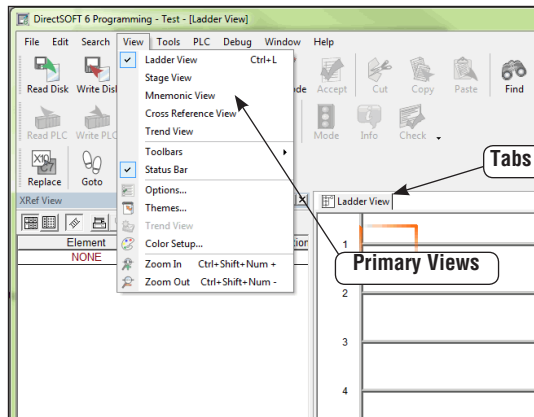

It is possible to open the Stage, Mnemonic and Trend Views along with the Ladder View by selecting the views one at a time from the View submenu, thus providing a Multi-Tabbed Interface (MTI) view. Once the views are open, you can switch from view to view by clicking on the appropriate tab in the display window. The Stage View also displays the Ladder View in the lower part of the view, therefore, it may not be necessary to open the Ladder View. This choice is left to the programmer.



One option is to have the **Documentation Editor** open as a tabbed view while editing a program. Selecting the Documentation Editor tab allows easy access to the editor. To open the editor, either press the **Documentation Editor** button on the Tools toolbar (if it is displayed), use **Tools > Documentation Editor** on the Menu bar or the keyboard shortcut **Ctrl + D**.

The **Trend View** is used to visually monitor the values of *Direct*LOGIC controller data elements over time. This View can monitor any readable numeric location or any readable bit location or any constant value. Trend View also logs the values of the controller elements on each pane of the Trend. Those values are displayed on a moving graph.

One more view, the **PID View**, will be useful if a PLC with PID loops is being used. This view is only available to the user after at least one PID loop has been setup. Once a PID loop has been setup, the PID View is opened from the View submenu on the Menu bar.

If multiple views are open in the Program display window at the same time, the tabs will appear as in the illustration below.

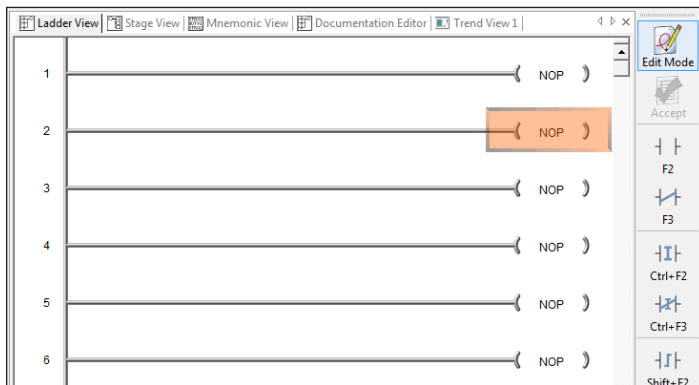

## Stage (RLL<sup>PLUS</sup>) View

Most of the *Direct*LOGIC PLCs support the RLL<sup>PLUS</sup> instructions. The instructions (Stage, Jump, etc.) enable you to create a structured program that can be viewed as a flowchart when the Stage View is enabled. A program flowchart may be easier to follow than a comparable ladder logic program.

### Troubleshooting RLLplus vs. RLL

The old saying, “can’t see the forest, because of all the trees” often holds true in ladder logic programming. Some RLL programs may contain many interlocks and complex rungs. It may be difficult to follow the logical flow of activity and the relationships between different parts of the program. This is where Stage programming can be better than ladder logic programming. As a ladder logic program is edited with stages, *Direct*SOFT6 will translate the RLL into the equivalent Stage View using much more compact, and easy-to-follow flow diagrams.



**NOTE:** Consult the PLC User Manual, Chapter 7, to learn how to incorporate Stage Instructions in a ladder logic program.

An illustration of a Stage View is shown below. The flowchart area is shown in the upper left part of the display while a ladder logic area is shown in the lower half of the display. The two windows are synchronized, in other words, when the flowchart is activated with the cursor, the ladder logic will scroll to the same position in the program. This can aid with troubleshooting the program. When testing a program online with a PLC (status ON), both the flowchart and the ladder logic will track each other, showing the power flow and transitions as they occur. It is possible to look at another part of the program by opening the Ladder View and tile the two views (refer to page 4-30). The right-hand corner view contains the stage comments. These comments are synchronized with the flowchart area of the display (refer to page 6-12 for details).

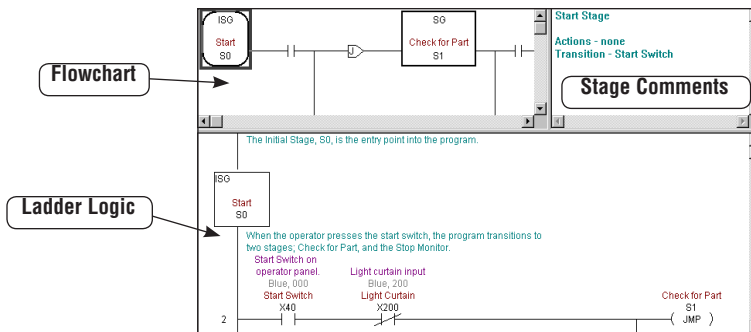

### Stage Components

If the flowchart area of the Stage View is being viewed and there is an uncertainty of what a component means, click on the component and the corresponding equivalent in ladder logic will come into view. Help (F1) can also be consulted for more clarity.



## Mnemonic View

### Handheld Programmer Aid

There may be times when a *DirectSOFT6* user will need to use a handheld programmer (HPP) to modify a *DirectSOFT6* ladder logic program. Since the HPP only uses mnemonics, the Mnemonics View will prove to be useful as a guide. Just open the Mnemonics View and print it on a printer. The hard copy can be carried to the PLC location. Consult the PLC User Manual (Chapter 5) for the proper keystrokes required for entering the mnemonic instructions.



0	ISG	S0
2	STR	X40
3	ANDN	X200
4	JMP	S1
5	JMP	S10
6	SG	S1
8	STR	X41
9	JMP	S2
10	STRN	X41
11	TMR	T1 K10
14	STR	T1
15	JMP	S5
16	SG	S2
18	STR	X51
19	SET	Y40
20	STR	X42
21	SG	S3
23	OUT	Y41
24	STR	X44
25	STR	CT0



**NOTE:** There are no display options for the Mnemonic View.

## Cross Reference (XRef) View

As mentioned on page 2-12, the Cross Reference (XRef) and Ladder Views open by default whenever a new project is started. The XRef View can be closed if desired, but since it is a dockable view, it is a good idea to dock it if you do not want to view all the time. Just click on the push-pin to dock it, and hover the mouse cursor over the XRef tab to bring it back into view. Then, click on the push-pin again or double-click on the XRef View bar at the top to “lock” it in position again. The XRef View has two viewing modes, **XRef Mode** and **Usage Mode**.

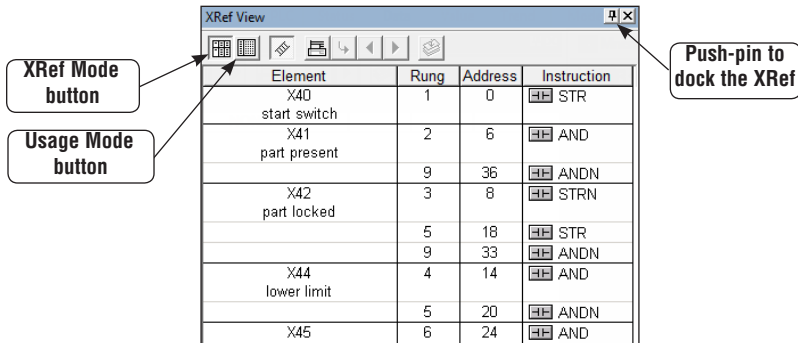

### XRef Mode

The XRef Mode is the default mode when the XRef View is first opened. When in XRef Mode, the Cross Reference Table reports information for all elements that meet the current Query which determines the elements to be included in or excluded from the XRef and Element Usage Tables. The table is divided into four columns:

- **Element** - reserved for the element ID, but will display whatever Query is selected in the Options dialog.
- **Rung** - rung number where the element is used.
- **Address** - the address where the element is located in the program.
- **Instruction** - type of instruction that contains the element.

A useful feature of the XRef Mode is to double-click the left mouse button on the Rung, Address or Instruction and the program will move to that location. Also, double-clicking the left mouse button on an element will cause the Element Browser to appear.

## Change the XRef Query

The XRef Element column can contain all four types of documentation available in the Options dialog. To change the Element XRef Query definition, first enable the XRef View by clicking the mouse on the table. Next, open the Options dialog from the Menu bar using **View > Options** or press the **Options** button on the Offline toolbar. You can also right-click anywhere in the XRef View and choose **Options** from the Local Menu. Choose the XRef tab and make the Query selections in the **Documentation** section to be displayed in the Element column. Press **OK** after making the selections.

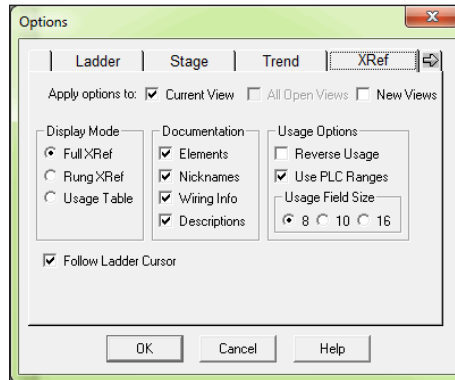

The other two sections located in the dialog, **Display Mode** and **Usage Options**, contain options that can be selected on the XRef View toolbar. Also notice the box to the left of the **Follow Ladder Cursor** option under the Display column. The box can be checked in this dialog or selected at will in the XRef Toolbar which is explained on the facing page.

## XRef Toolbar

The Cross Reference View has a toolbar to move quickly to different locations and views in a program. The available buttons can be seen in the illustration below.

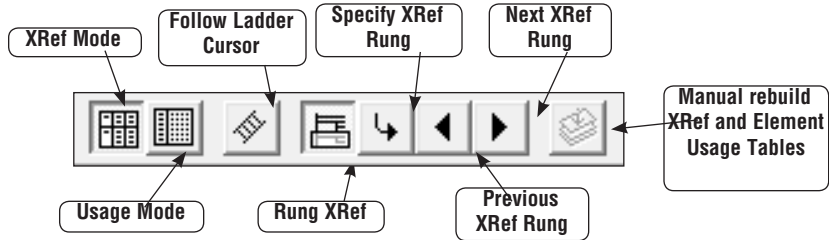

- **XRef Mode** – this button brings the Cross Reference table into view if it is not in view.
- **Usage Mode** – pressing this button brings the Element Usage table into view.
- **Follow Ladder Cursor** – when the XRef View is enabled, the rung information will be placed at the top line of the table for any rung where the ladder cursor is positioned.
- **Rung XRef** – this button transfers the current mode to a one rung mode which only displays one rung in the table.
- **Specify XRef Rung** – enabled only in the single rung view. Enter a rung number or an address in the dialog pictured below, then click **OK**. The program will go to and display the rung number entered.

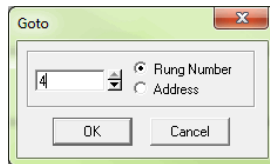

- **Previous XRef Rung** – the Ladder View will display the previous rung while only in the Rung Mode.
- **Next XRef Rung** – the Ladder View will display the next rung while in only the Rung Mode.
- **Manual Rebuild XRef and Element Usage Tables** – manual rebuild for elements either added or deleted later in a program. This button will be inactive unless Auto Rebuild is not selected in the XRef DB dialog (see page 7-11).

## Usage Mode

The Usage Mode is selected to display the Element Usage Table in the current Cross Reference View. The Element Usage Table displays all elements that meet the current Query. The table is an effective way to see which points have been used, which points are free and whether or not they have been used in a range. The elements are shown in groups of 8, 10 or 16 bits as determined by the current Usage Field Size setting

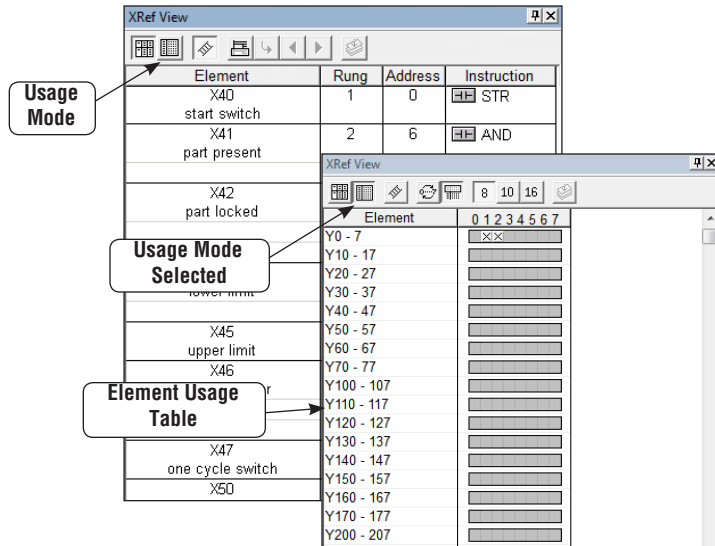

## Usage Mode Toolbar

The Usage Mode toolbar is used to select various options for viewing the Element Usage table.

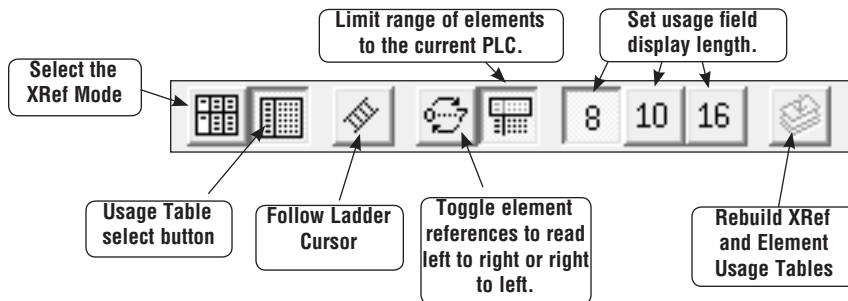

### XRef DB

There is another tab on the Options dialog that can be used for setting up the Query for the XRef View. It is the **XRef DB** tab as seen in the dialog below. This dialog opens with the default selections as shown. In most cases, this dialog should remain as is. The Auto Rebuild may be the only selection to be disabled if it is desired to manually update the Cross Reference View whenever an element is added or deleted.

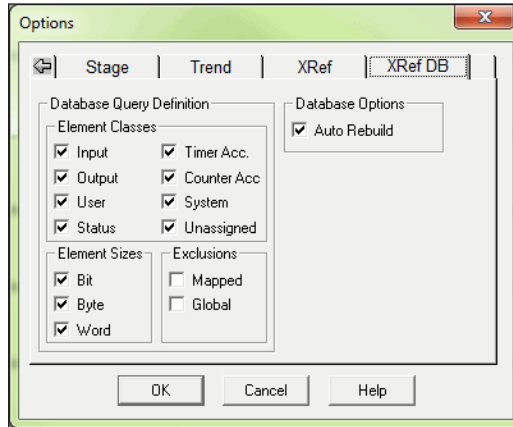

## PID View

The **PID View** will be useful as a PID loop tuning aid. To access this view, at least one PID loop must be setup.



**NOTE 1** Refer to your PLC User Manual, Chapter 8, PID Loop Setup to setup a PID loop.

**NOTE 2:** PLC View is not available until you are connected with a PLC and at least one PID loop is configured.

## PID Setup

To setup a PID loop, the PC must be connected to a PLC which is online. To begin, either press the **PID** button located on the **PLC Setup** toolbar (if displayed) or use **PLC > Setup > PID**. This will open PID Address dialog as pictured below.

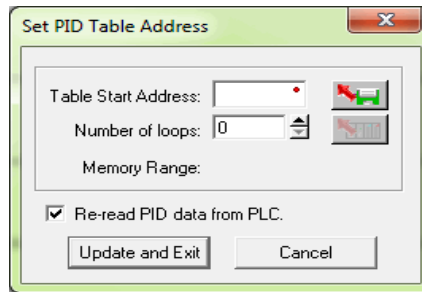

After this dialog has been completed and saved, the **Setup PID** dialog, pictured below, is opened. The Setup PID dialog is a series of dialogs used to setup one or more PID loops. Use the PLC User Manual as a guide to setup the loop(s).

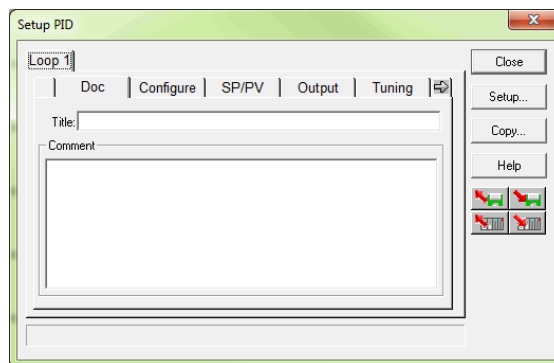

Once a PID loop has been setup, open the **PID View** by selecting it from the View submenu on the Menu bar. A Data View can also be open to assist in tuning the PID loop(s).

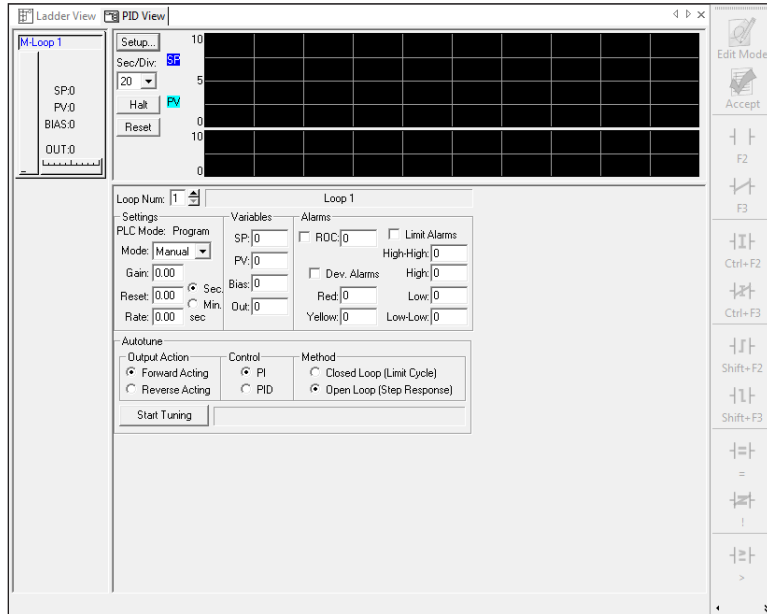



## Trend View

The **Trend View** can be used as a debugging tool. As mentioned previously, it is used to visually monitor the values of *Direct*LOGIC controller data elements over time. It has the ability to monitor any readable numeric location or any readable bit location or any constant value. Those values are displayed on a moving graph and can be logged and exported to a CSV file for importing into a third-party application for further research.

### Creating a new Trend View

A new (empty) Trend View can be created by selecting **Debug > Trend View > New** from the Menu, or clicking the Trend button on the Online toolbar. The following dialog is displayed prompting for the number of Panes to initially create.

Enter the number of Panes in the Number of Panes field or use the Up or Down arrow to set the value. Click the OK button to accept or the Cancel button to abort.

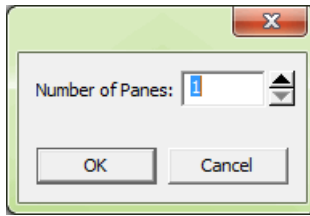

A Trend View can also be created and pre-filled with the critical elements by the following methods:

- Right-clicking anywhere in a Data View and selecting Trend All.
- Highlighting a range of elements in a Data View, then right-click and select Trend Selection.

The next window to appear is the Trend View Options window as seen on following page. This window contains all of the parameters available for the new Trend View. Enter Starting and Ending elements, desired display characteristics and historical options in this window.



**NOTE:** Refer to the *DirectSOFT6* help file for more information on configuration options and features of Trend View.

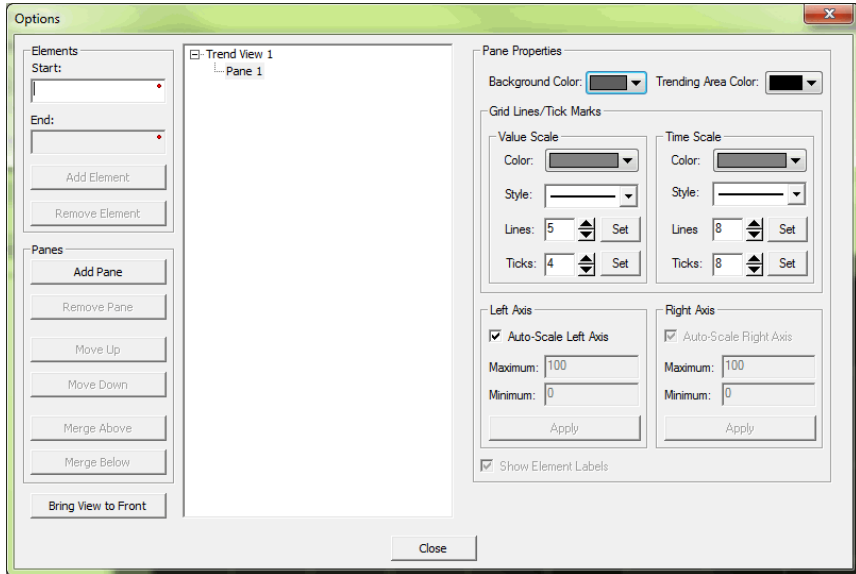

If the element to be added is not a bit or a constant, then this causes a secondary dialog to be displayed so that the Format and Size can be determined. Once determined, the OK button will accept the selections. An example Trend View is shown below.

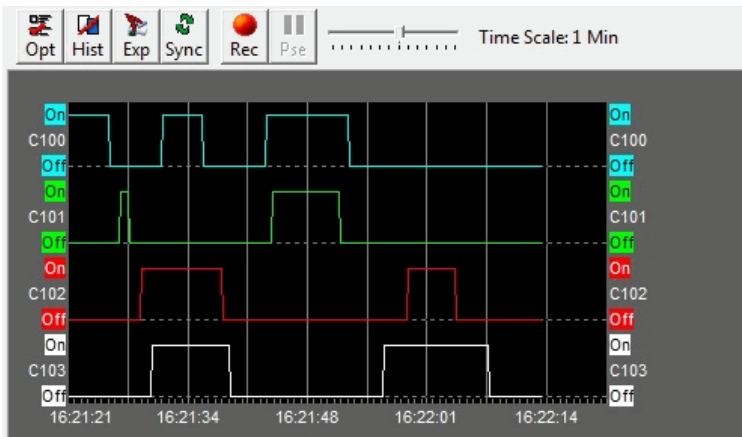
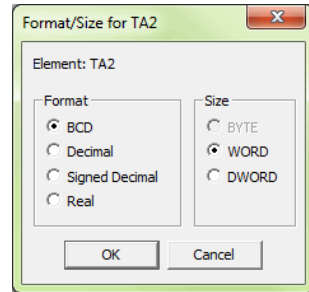

## Output Window

There may be an occasion when a mistake(s) has gone unnoticed while a program is being edited. The mistake(s) will be detected by DirectSOFT6 whenever the program is accepted (compiled), and displayed in the Output window as shown below.

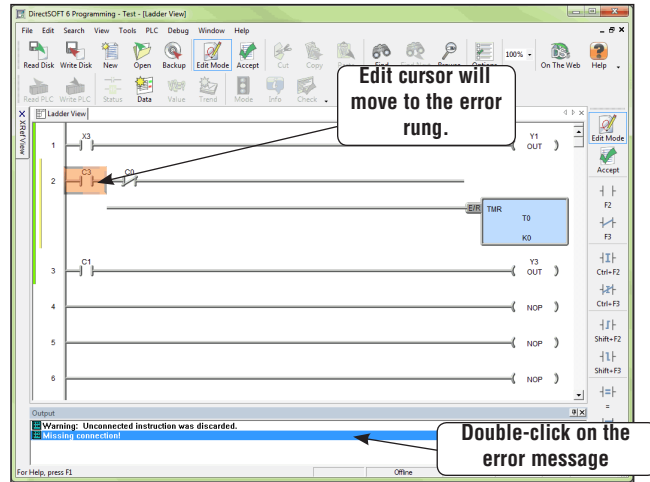

The Output window will appear below the view being displayed, in this case, the Ladder View. Each mistake or error message will be listed. Double-clicking on the error in the Output window will move the edit cursor to the error rung in the ladder view. Once all of the errors are corrected, the program can be compiled. The error messages in the Output window will disappear but the window will remain in view as can be seen in the diagram on the facing page.

In the diagram above, notice the push-pin in the upper right-hand corner of the Output window. Clicking on this push-pin will auto-hide the window, and a tab will be displayed in the lower left-hand corner. More about auto-hide and dockable views will be discussed beginning on page 7-19.

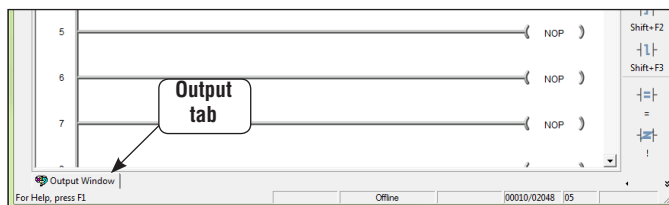

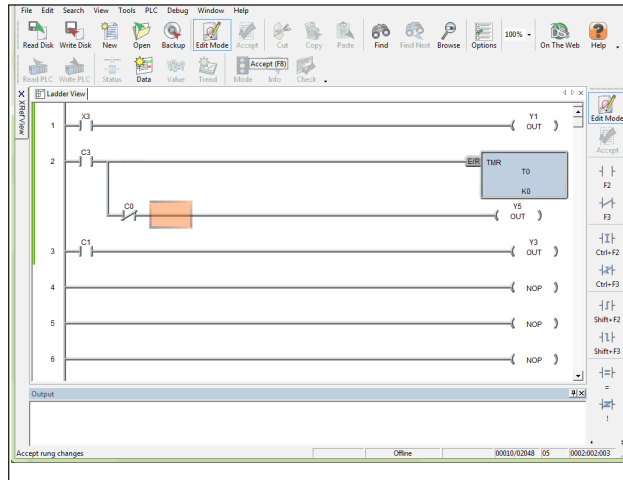

The Output window can be closed just like other windows are closed. If you desire to open the Output window, press the **Output** button located on the Windows toolbar if it is displayed.



If the Output window is displayed with error messages, it can be cleared by pressing the **Clear Output** button located next to the Output button on the Windows toolbar.

## Bookmark

A feature which can be used as either an editing or a debugging aid is the **Bookmark** feature. This feature allows the programmer to mark one or more rungs in his program if he wants to quickly go to a marked rung. To use the feature, simply have the cursor located on a rung and hold the <Ctrl> key down and press the left mouse button (this will only work with the mouse button). The rung which is bookmarked will appear in the Output window. Once the bookmark has been made, you can double-click on the bookmark in the Output window and *DirectSOFT* will jump to that rung and display it. The Output window can also be hidden by clicking on the push-pin. The Output window can then be recalled by clicking on the Output tab. Closing the Output window will clear all bookmarks.

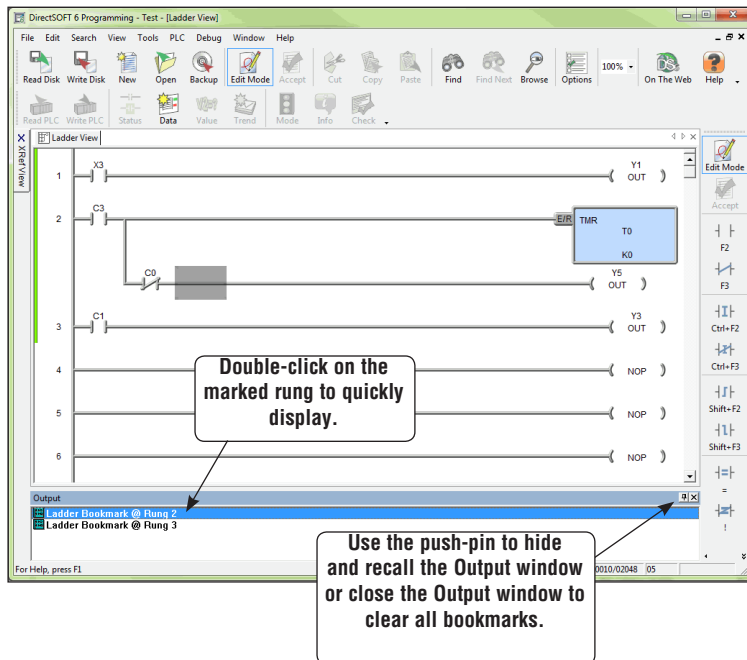

## View Terminology

The terms “docked view” and “floating view” have been used in this manual and will be clarified in this section. A “Docked View” or a “docked toolbar” is a view, or toolbar, that is “docked” to a specific edge of the Programming window. Initially, the Offline toolbar is docked at the top of the Programming window below the Menu bar. The Online toolbar is also docked at the top, but below the Offline toolbar. The Ladder Palette toolbar is initially docked on the right edge of the Programming window, and the Cross Reference View is docked on the left edge of the window. Primary views (Ladder, Stage, PID, Trend, etc.) appear within the “Tabbed MDI View” (Multiple Document Interface) area between the various docked views/toolbars. The primary tabbed views are shown in the diagram below.

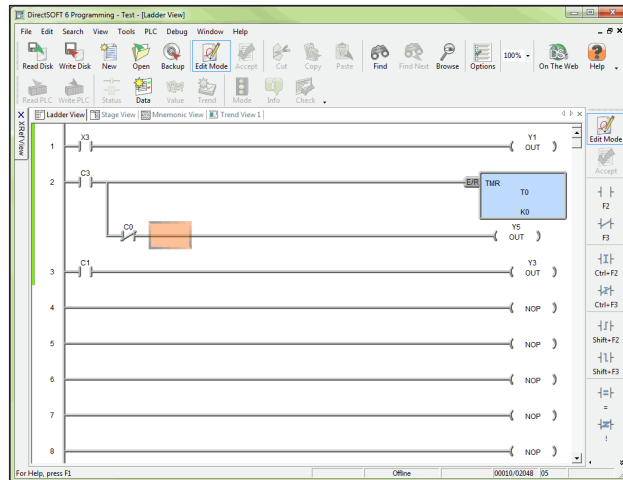

Viewing the example on the next page, each of these docked views/toolbars can be docked on any edge (e.g. the XRef View can be moved and docked on the right or on the bottom). Notice that the XRef View has been unpinned and placed in a floating position. In this position, the XRef View cannot be placed in a auto-hide position by pinning it until it is back in a docked position.

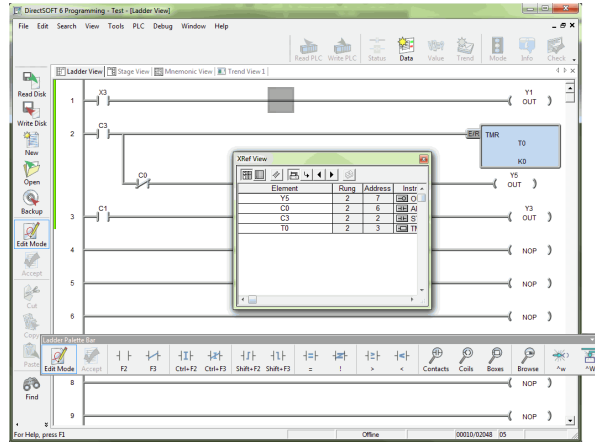

All docked views/toolbars can also be Floating views/toolbars, and float outside the application frame (very handy if multiple monitors are being used). The remaining area, bounded by all of these docked views/toolbars, is where the primary MDI Views are positioned.

One final user interface for dockable views is the capability to group only the dockable views to create a tabbed group of multiple docked views (e.g. 2 Data Views and the XRef View can all be placed in a single tabbed group). This tabbed group can then be docked, floated or auto-hidden as a single entity. To create this tabbed group, open all of the Data Views to be placed in the group, then drag one Data View on top of a second Data View, and so forth. You can also drag the XRef View over the top of this group to complete the single dockable, tabbed group.

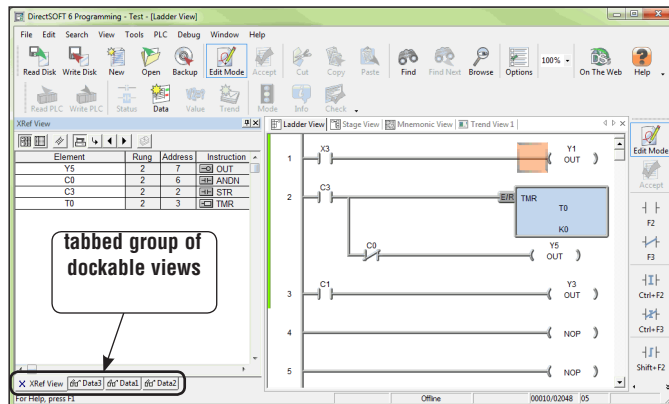

The following table lists all of the different views/toolbars and all of the possible frame behaviors.

Window Frame Behaviors						
<i>DirectSOFT6</i> Window Type	Individual MDI (cascade, tile, etc. like Rel 4)	Tabbed MDI	Docked to Edge	Auto- hidden Docked to Edge	Floating	Tabbed Group of Docked/Auto- Hidden/Floating
All Toolbars			√*		√	
Ladder View	√	√*				
Stage View	√	√*				
Trend View	√	√*				
Documentation Editor	√	√*				
PID View	√	√*				
Mnemonic View	√	√*				
Cross Reference/ Usage View (XRef)			√*	√	√	√
Data View			√*	√	√	√
Output Window			√*	√	√	√

\* Default behavior

Note that the Docked/Floating/Auto-hidden/Tabbed Framed windows can all be independently set on a frame by frame basis. For example, you can have the Ladder Palette and the PLC Setup toolbars floating on a second monitor, with the Offline and Online toolbars being docked on the top edge; then have one Data View floating and three other Data Views grouped as a docked tab to the right side of the application; and have the Cross Reference View auto-hidden, and docked on the bottom edge of the application.

However, the two different MDI Frame behaviors are exclusively either/or. This means that within a *DirectSOFT6* session, all of the MDI views behave either as individual MDI frames or as tabbed views, but not both at the same time. You cannot have the Ladder View be a tabbed view and the Stage View and PID View be cascaded as Individual MDI frames. All MDI Views will have Individual behavior or Tabbed behavior.



Examples of the various Window Frame Behaviors are in the picture below.

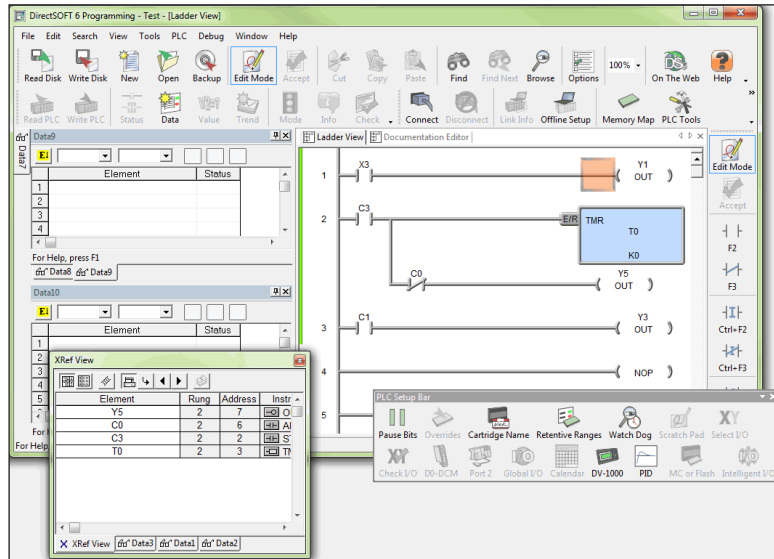

- Ladder View and Documentation Editor – **Tabbed MDI View** with Ladder View currently selected.
- Offline toolbar, Online toolbar and PLC toolbar – **Docked** to the top edge of the application, just below the Menu bar.
- Ladder Palette toolbar – **Docked** to the right edge of the application.
- Data View Data10 – **Docked** to the left edge of the application.
- Data Views Data8 and Data9 – **Docked as a Tabbed Group** to the left edge of the application, with Data9 currently selected.
- Data View Data7 – **Auto-hidden/docked** Data View that is docked to the left edge of the application.
- XRef View – **Floating** XRef View that is floating outside the borders of the *DirectSOFT6* application window.
- PLC Setup – **Floating** toolbar that is floating outside the borders of the *DirectSOFT6* application window.

# PRINTING

---



## In This Chapter...

Print the Current View .....	8-2
Print Multiple Views .....	8-5
Print View Common Setup.....	8-7
Using Print Preview .....	8-8
Print Troubleshooting .....	8-10

## Print the Current View

A printout of the program can be very useful when developing a program. A printout will provide a full view of whatever view is displayed in the *DirectSOFT6* programming window.

### Print the Ladder View

To print the Ladder View, use the **Print** dialog to select the printing options. To open the Print dialog either select **File > Print** on the Menu bar, press the **Print** button on the File toolbar if it is displayed or use the keyboard shortcut **Ctrl + P**. The Print dialog will appear like the one shown below.

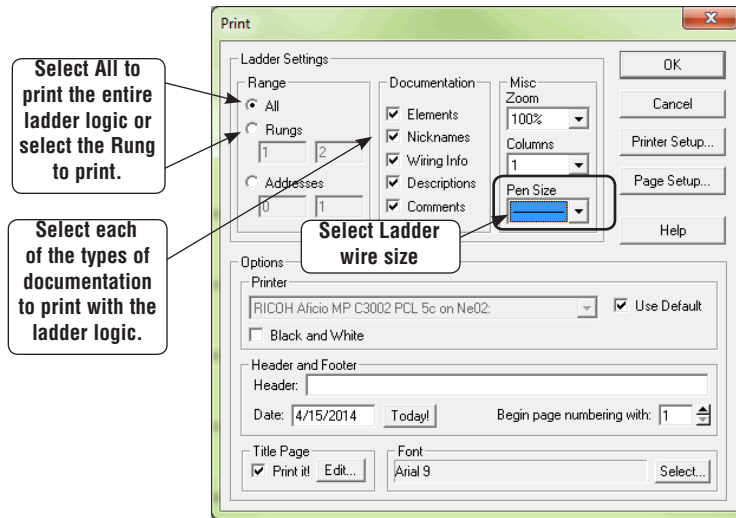

In this dialog, you can set the range to print all or any part of the ladder logic by either selecting **All**, **Rungs** or **Addresses** to be printed. Select any or all of the ladder documentation to print with the ladder logic. The **Miscellaneous** settings allows the level of zoom to print and the selection of the number of columns to print, also, the **Pen Size** allows the selection of the thickness of the pen used to draw wires, contacts, coils and boxes on high resolution printers.

## Other Print Views

There are three additional current view print dialogs, Mnemonics, Stage and Cross Reference. Each dialog is a bit different than the Ladder dialog as noted in the following diagrams. Each view must be enabled (current view in the programming display) to open the Print Views.

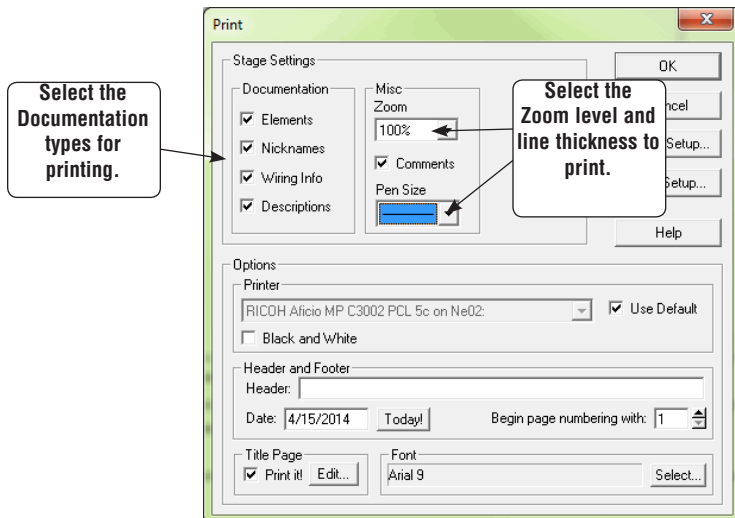
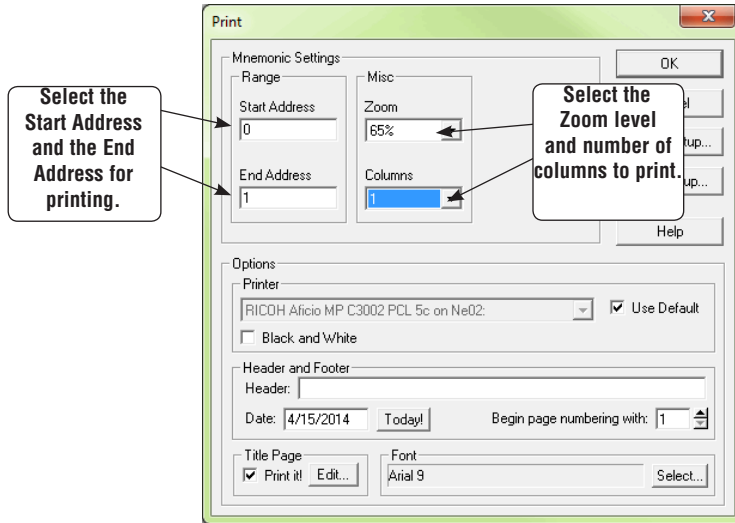

### Cross Reference Print Dialog

The image shows a 'Print' dialog box for cross-references. It is divided into several sections: 'Cross Reference Settings', 'Options', and 'Header and Footer'. The 'Cross Reference Settings' section includes a list of elements (Unassigned, X, Y, C, S) with checkboxes, a 'Columns' dropdown set to '2', and buttons for 'Edit...', 'Set All', and 'Clear All'. There are also checkboxes for 'XRef' and 'Usage'. The 'Documentation' section has checkboxes for 'Elements', 'Nicknames', 'Wiring Info', and 'Descriptions'. The 'Options' section includes a 'Printer' dropdown (Adobe PDF on Ne03), a 'Black and White' checkbox, and a 'Use Default' checkbox. The 'Header and Footer' section includes a 'Header' field, a 'Date' field (4/16/2014), a 'Today!' button, a 'Begin page numbering with' field (1), a 'Title Page' checkbox (checked), and a 'Font' dropdown (Arial 9). Callout boxes provide instructions: 'Edit the range of the current element.' points to the 'Edit...' button; 'Set All enables (checks) all elements.' points to the 'Set All' button; 'Clear All disables (Unchecks) all elements.' points to the 'Clear All' button; 'Select the Elements to print the xref for.' points to the element list; 'Select the number of columns to use for printing XRef/Usage printouts.' points to the 'Columns' dropdown; 'Check to include the XRef printout and select the documentation to be printed.' points to the 'XRef' checkbox and the 'Documentation' section; 'Check to include the Usage printout and check the options to be printed.' points to the 'Usage' checkbox and the 'Documentation' section.

**Edit the range of the current element.**

**Set All enables (checks) all elements.**

**Clear All disables (Unchecks) all elements.**

**Select the Elements to print the xref for.**

**Select the number of columns to use for printing XRef/Usage printouts.**

**Check to include the XRef printout and select the documentation to be printed.**

**Check to include the Usage printout and check the options to be printed.**

## Print Multiple Views

The advantage of using the **Print All** dialog is that all of the available print views are available using one dialog. Open the dialog by either selecting **File > Print All** on the Menu bar or press the **Print All** button on the File toolbar if it is displayed. The following dialog will appear.

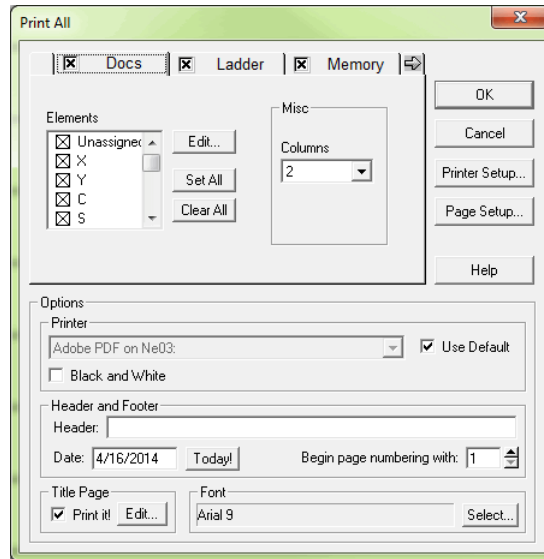

The tabs located at the top of the dialog are used to select the print dialog and printout setup. Click on the tab to select the print view. The print views available when the Print All dialog is opened are: Documentation, Ladder and Memory. Clicking on the “right arrow” on the dialog will move the Mnemonics, Stage and XRef tabs into view. Select the views to be printed by checking the check box next to the view named on the tab. The use for all of the available views has been explained with the exception of the Docs and Memory tabs seen in the Print All diagram.

**Docs tab** – check the elements for which to print documentation

### Elements

- **Edit** – edit the range of the current element.
- **Set All** – enables (checks) all elements to print.
- **Clear All** – disables (unchecks) all elements to print.

**Memory tab** – check the V-memory addresses to print the desired values.

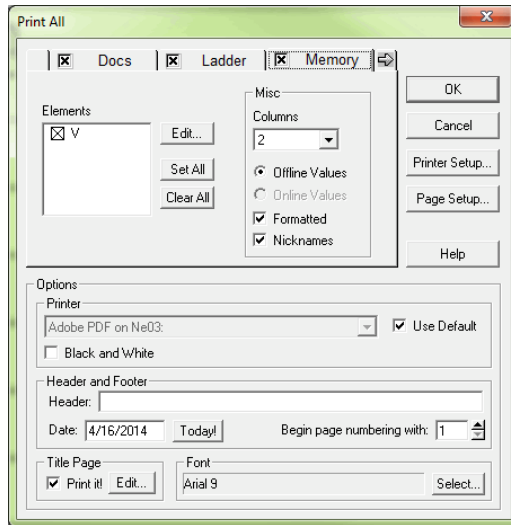

### Elements

- **Edit** – edit the V-memory range.
- **Set All** – enables (checks) all V-memory to print.
- **Clear All** – disables (unchecks) all V-memory to print.

### Miscellaneous

- **Columns** – select the number of columns to use for the V-memory printout.
- **Online / Offline Values** – select whether online data or offline data is to be printed.
- **Formatted** – use previously saved format information rather than raw data.
- **Nicknames** - check this to show nicknames instead of element IDs.

## Print View Common Setup

The **Printer Setup**, **Page Setup** and **Options** are common to all of the Print Views.

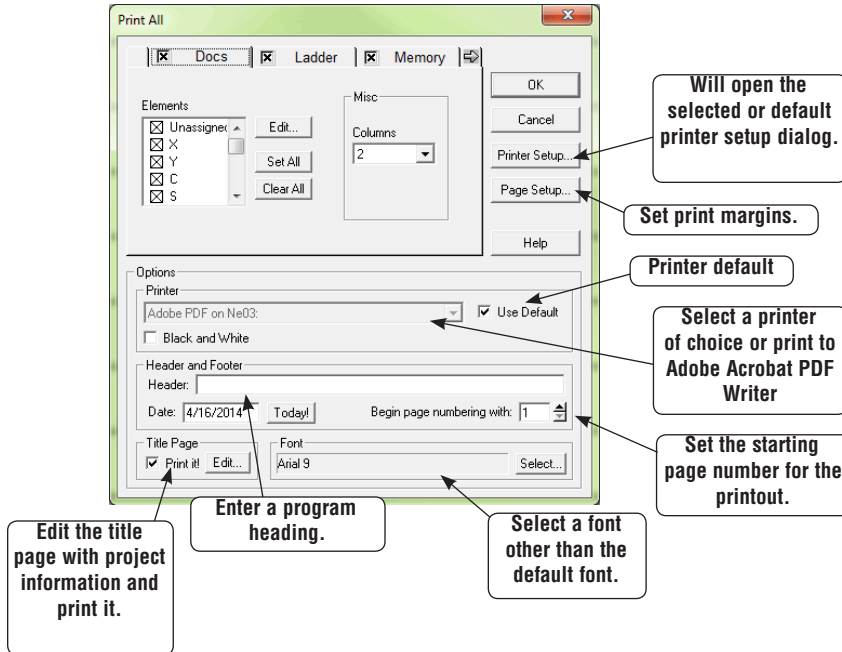



# Using Print Preview

**Print Preview** is available and is recommended before printing the program. One advantage for using Print Preview before printing is saving printer paper. You will be able to see how the program will appear on paper before it is printed, and corrections can be made before printing.

## Print Preview Setup

Either open the Print Preview dialog from the Menu bar using **File > Print Preview** or press the **Preview** button on the File toolbar if it is displayed. Notice that the Print Preview dialog is the same as the Print dialog. The Print Preview is setup in the same manner as the Print dialog, Use the dialog to setup the printer, the page margins, setup the rest of the print options then press **OK**.

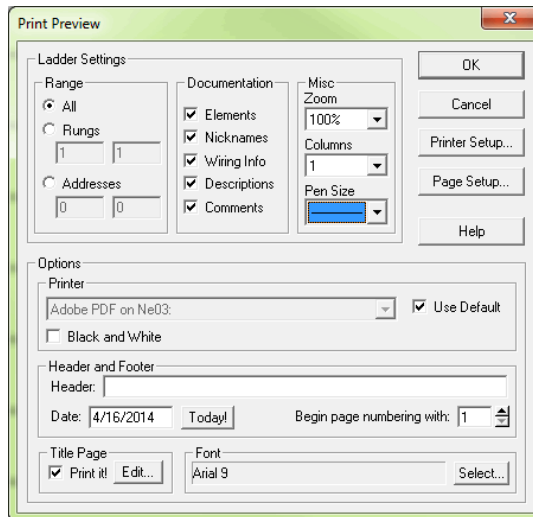

## Print Preview

After pressing the OK button, the Print Preview will appear using the full computer screen. Use the **Page** buttons at the top of the display to scroll through the program. **One Page** can also be selected and switched back to two page when desired. If the displayed program does not appear the way you want to, press the **Settings** button to return to the setup to make corrections. Once the program preview looks the way you want it to look, press the **Print** button.

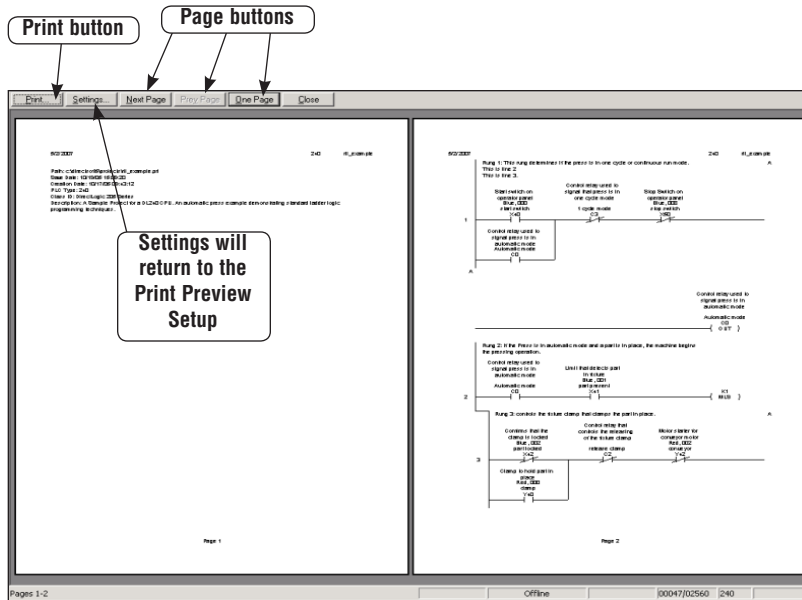

# Print Troubleshooting

## Parts of Program not Printed

If the program looks good in Print Preview but some parts do not appear on the program printout, there may be a problem with the color setup. When generating the data sent to the printer, *DirectSOFT6* will attempt to make the program printout look as close to the on-screen version as possible, including the colors. If a color printer is being used, there probably isn't enough contrast between the background and whatever is being printed. If the printer is black and white, the same lack of contrast could be the problem because *DirectSOFT6* will try to generate gray-scale colors to match the display colors.

One way to solve this problem is to tell *DirectSOFT6* to use monochrome (black and white) for display. If the **View** toolbar is displayed, press the **Color** button, otherwise, go to **View > Color Setup** and click on the **Monochrome** button, then press **OK**. After printing is complete, you can return to the Color Setup dialog to restore the original setting.

## Program Prints “Garbage”

As a general rule, if the Ladder View looks correct in Print Preview but the program printout shows “garbage”, the first thing to suspect is the printer driver being used. Look on the printer manufacturer's website for the latest driver for the printer, then download it and install it on the computer. Once this is done, print one page of the program in Print Preview to be sure that the problem has been corrected.

## DirectSOFT6 Crashes

If *DirectSOFT6* crashes whenever **Print** or **Print Preview** is selected, there may be a corrupted printer setting file in *DirectSOFT6*. Each project has a printer settings file that is generated whenever a new project is created. It will reside in the project folder, and will have an extension of **.prt**.

To correct this, close *DirectSOFT6* and delete this file by using Windows Explorer. Reopen *DirectSOFT6* and try the print operation again.

Another reason for *DirectSOFT6* crashing whenever **Print** or **Print Preview** is selected may be from corrupted global printer settings files. There are two files located in *DirectSOFT6*\Program\Bin sub-folder named **PrntSrv.rst** and **Program.opt**. These files can be deleted from the directory after closing *DirectSOFT6*. Locate the two files by using Windows Explorer. After deleting the files, reopen *DirectSOFT6* and try the print operation.

## Print Setup Dialog

The **Print Setup** dialog deserves to be mentioned. Print Setup can be invoked by either using **File > Print Setup** or pressing the **Print Setup** button on the File toolbar. The dialog that appears will be the **Properties** dialog for the printer being used. If necessary, printer settings can be made here as well as choosing the page layout which includes Landscape and Portrait orientation.

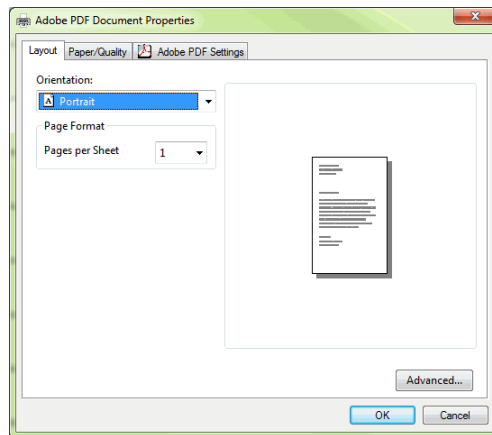

# SETUP AND MANAGE COMMUNICATION LINKS

---



## In This Chapter...

Establish the Communications Link .....	9-2
Setup a Serial Link .....	9-2
Setup an Ethernet Link .....	9-7
Setup a Modem Link .....	9-14
Comm Link Options .....	9-22
Going Online .....	9-24

# Establish the Communications Link

In order to download a program to the PLC a communications link must be established. If your PLC is connected to your computer by a serial connection or USB-to-Serial converter, **DirectSOFT6** should be able to auto-configure your communications link for you. If you are using an Ethernet link or if for some reason your serial link does not auto-configure, you can follow the steps below to manually configure a communications link to your PLC.



**NOTE:** For tips on troubleshooting a communications link, see Appendix B

## Setup a Serial Link

Connect the programming cable from the serial port of the PC to the serial port of the PLC (see Appendix A for selecting the proper cable for your PLC). If your PLC has a **RUN/TERM/STOP** switch, place it in the **TERM** position. The Link Wizard can automatically determine the majority of communication settings for the PLCs.

To establish a new link, activate the Link Wizard from the launch window menu tree, by right-clicking on **Comm Links**, and then click on **Add Link** in the dialog that appears.

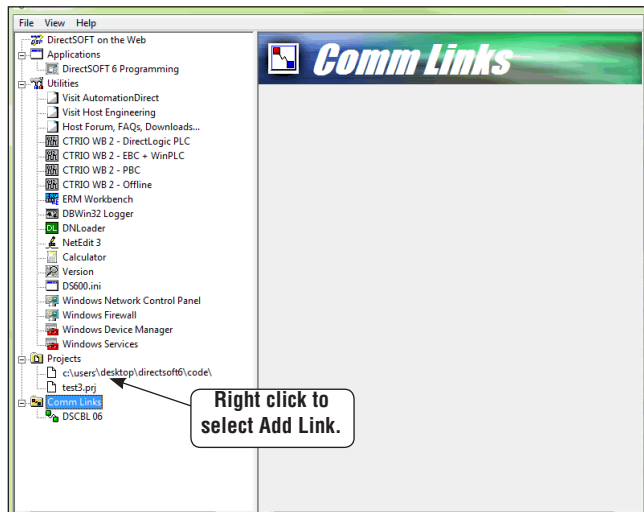

1. The next step is to select a communications port. The window at the top of the facing page will appear showing a list of communication ports. For serial communication, select the port you will use (commonly COM1) and click **Next**.



**NOTE:** The COMM ports shown in the window below are those which **DirectSOFT6** will attempt to use. Simply because a COMM port is shown in the list does not mean the port actually exists on the PC. Open Windows Control Panel and verify that a port exists in Device Manager.

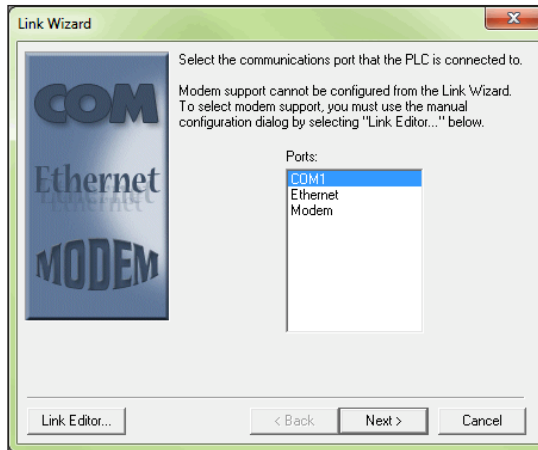

**NOTE:** The comm port on your PC may have to be enabled (example, COM5). See Appendix B, DS600.ini File

- The next window will show a list of **PLC Families**. Select the PLC family by clicking on the appropriate choice. If you are unsure of the PLC family but know which communications protocol to use, select **“Not Sure”**. If you are using a **DirectLOGIC** compatible PLC, the Link Wizard will try and detect the PLC type automatically. Click **Next** when you are finished.

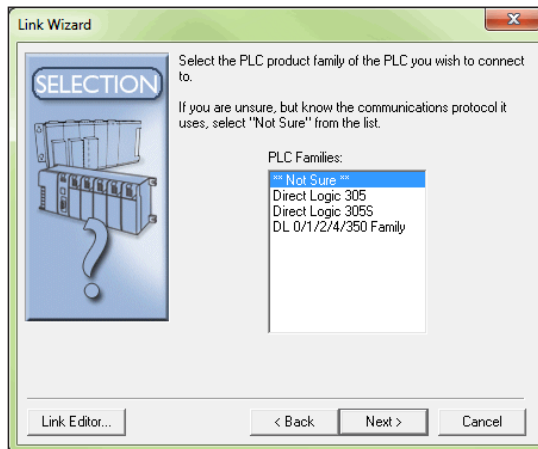

- Now, to choose the protocol and node address. In this step, you will see a choice of either **DirectNET** or **K-Sequence**. Assuming you have selected the **DirectLOGIC** PLC family (not the DL305), the default, K-Sequence, will be highlighted. The K-Sequence protocol allows you to perform write operations to individual discrete I/O points and control relays. **DirectNET** protocol cannot write to individual bit locations. (See Appendix A for a list of protocols available for **DirectLOGIC** and compatible PLCs). If your PLC has been configured with a node address other than 1, enter that address now. Click **Next** when finished.

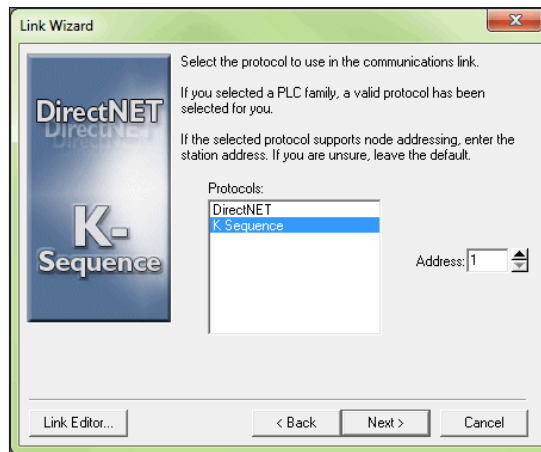

- The Link Wizard will attempt to establish a communication link with the PLC using the node address and protocol you have selected. It will try the combination of 9600 Baud, and Odd Parity. If this combination is unsuccessful, an 'auto-baud' sequence will be used to try and determine the correct baud rate and parity combination. If these attempts are unsuccessful, the dialogs shown at the top of the facing page will be displayed. You can click on the Link Editor button, and manually attempt to adjust the port configuration. See Appendix B for further help.



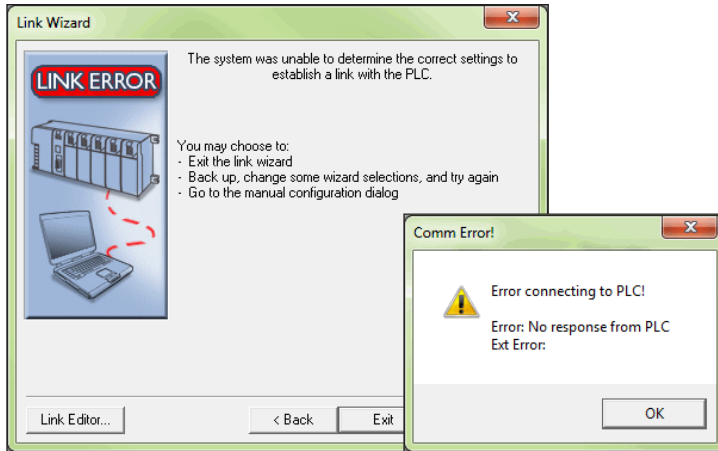

5. If the Link Wizard is successful in communicating with the PLC, the following window will prompt you to enter a unique link name, and a description of the link if desired. The description field allows 32 characters. Enter the name for the link and description then click Finish to return to the DSLaunch window.

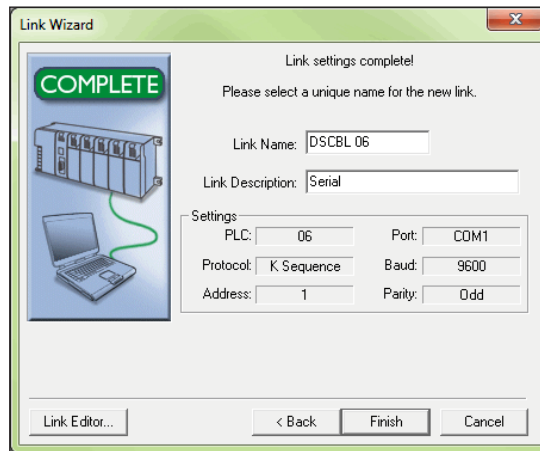

### Link Status

After creating a link, the name of the link will be displayed in the menu tree under the **Comm Links** folder icon. When you click on the link all of the configuration information will be displayed in the DSLaunch window. The status field is color-coded to help easily identify the link status.

- **Green** – link is enabled (it is active and you can use it).
- **Yellow** – a link becomes inactive while that specific link is being edited using the Link Editor.
- **Red** – communication error, i.e., the link has been broken or the PLC has lost power. *DirectSOFT6* will automatically attempt to re-establish the link.

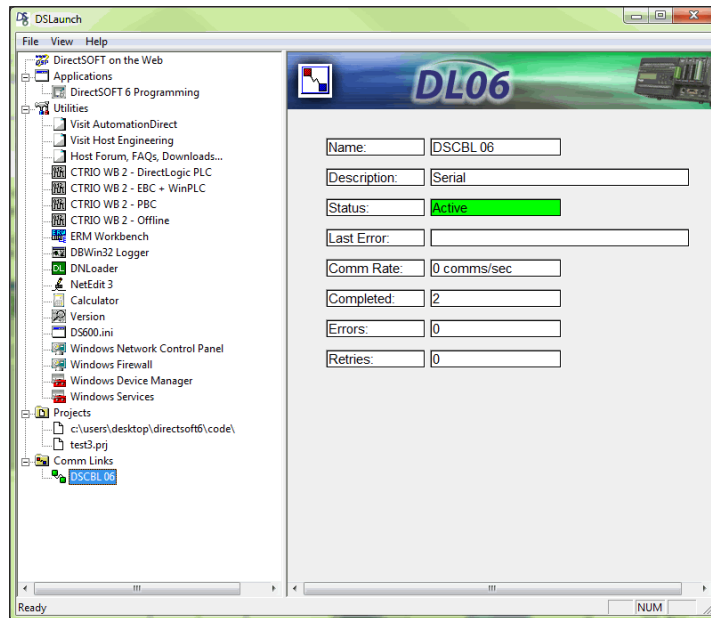

## Setup an Ethernet Link

The Ethernet link is setup using an Ethernet Communications Module (ECOM) installed in the PLC. The *DirectSOFT6* Link Wizard is used to setup the link. The Link Wizard will automatically determine the majority of the communication settings. It will search for any existing connections and try to establish the link. If a link is not present or a new link is to be established, the Link Wizard will need to be activated. The following steps will guide you through the link setup.

1. Open the Link Wizard from the DSLaunch window. Right click on Comm Links folder in the DSLaunch menu tree, then select Add Link.

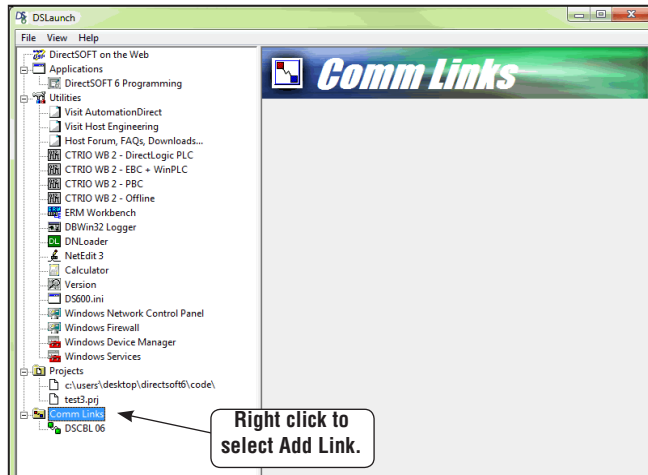

2. Select Ethernet as the port in the Link Wizard dialog, then click **Next**.

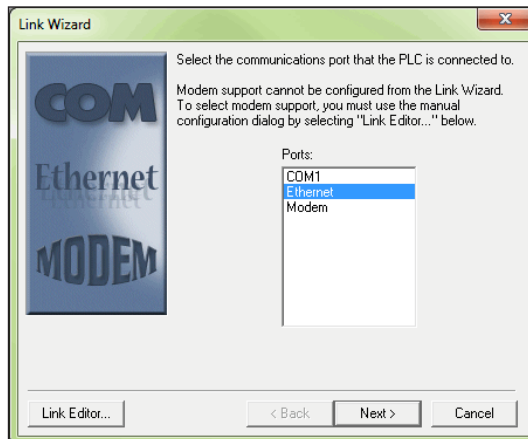

- The **Transport** and the **Transport Protocol** is chosen in the next dialog. The Transport is nothing more than a network driver. Note the following restrictions:
  - If the Operating System is Windows XP then you can choose either IPX or UDP/IP. Windows Vista, 7, 8 and 10 users must choose UDP/IP.
  - If UDP/IP is chosen as the Transport Protocol, the PLC ECOM module IP address must be changed from its default of 255.255.255.255 before communication will occur. The following dialogs are used for this.

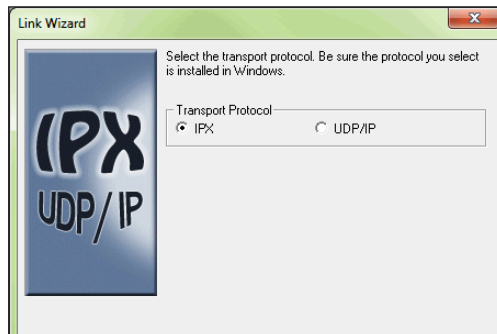

- DirectSOFT6** will use the specified Transport and Transport Protocol to scan the network for any Ethernet module on the network. After the scan is complete the following dialog will be displayed.

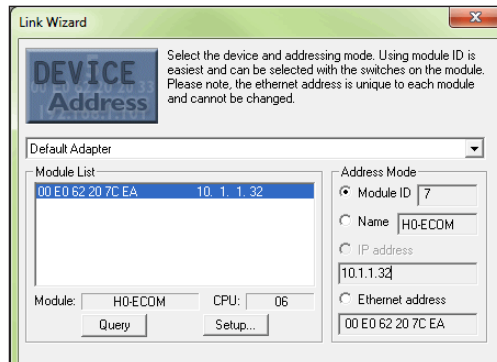

**NOTE:** If the dialog is blank, use the drop down list to select the specific Network Adapter (NIC) that the PLC is connected to. If the list is still blank after selecting the specific Network Adapter, then you will need to use NetEdit 3 to set up the ECOM module.

If the ECOM module has been setup using NetEdit 3, the Link Wizard dialog will display the information as shown in the sections named **Module List** and **Address Mode**.

The Module List will display the Ethernet modules that are found on the network, sorted by their Ethernet address. The Ethernet addresses displayed are unique 12 digit addresses assigned to the Ethernet module at the factory. The ECOM module will have a label with the assigned address printed on it. When a device address is selected in the Module List, the current configuration for the selected device is displayed in all fields of the dialog.

The Address Mode section displays the module information that was setup using NetEdit 3. There are three module identifiers shown: Module Id, Name, IP address and Ethernet address. Any one of these identifiers can be chosen so the **DirectSOFT6** can locate the Ethernet module on the network.



---

**NOTE:** It is important to have a unique identifier for the Address Mode on the network.

---

If for some reason you want to change the module's configuration, press the **Setup** button to make the adjustments. The following dialog will appear.

The configuration for the module selected in the **Devices** field will appear. The fields that are not grayed out can be changed. Be cautious not to duplicate any of the information when making changes.

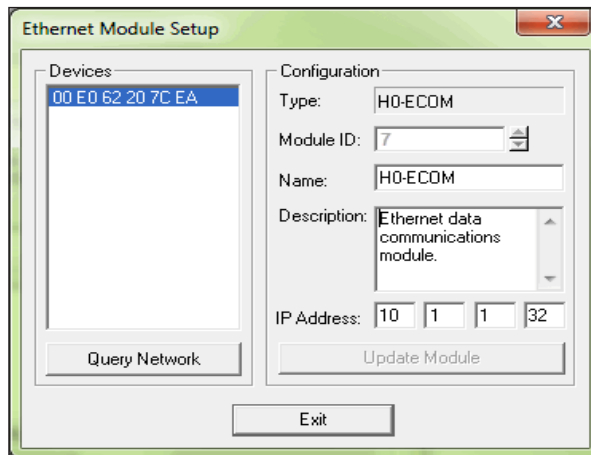

Referring to the Ethernet Module Setup dialog on the previous page, the following Configuration fields can be changed:

- The **Module ID** should be a unique numerical identifier. If this field is grayed-out, the module ID dip switches have been set. The only way to change the ID is to change the dip switches (refer to your particular ECOM User Manual). If the field is accessible, enter a new ID.
- The **Name** field can contain up to 32 characters in length. If there isn't a name in the field or the name is to be changed, enter a unique name.
- The **Description** field can contain any description limited to the available field.
- The **IP Address** field should only be changed whenever the network IP address is changed (refer to your particular ECOM User Manual). The Network Administrator should be able to provide the address.

After making any change, press the **Update Module** button and the changes will be written to the ECOM module.

The **Query Network** button will initiate a rescan of the network using the Transport and Transport Protocol previously specified.

Press the **Exit** button when the changes have been completed.

5. **DirectSOFT6** will attempt to communicate with the Ethernet module using the specified parameters. If successful, the following dialog will ask for a unique **Link Name** (up to 16 characters) and an optional **Link Description** (up to 32 characters) to be entered. Press the **Finish** button to save the link configuration to disk.

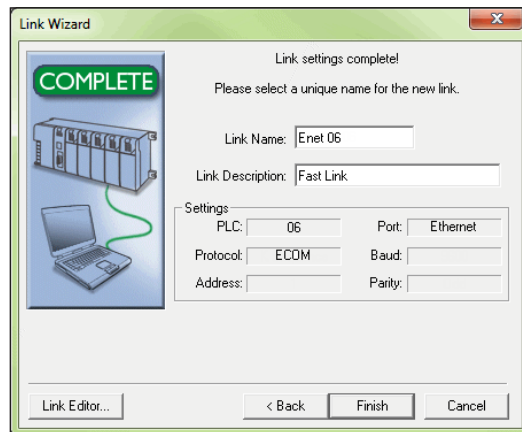

- The successfully created link will be listed with all other links in the **DSLaunch menu tree in the Comm Links folder**.

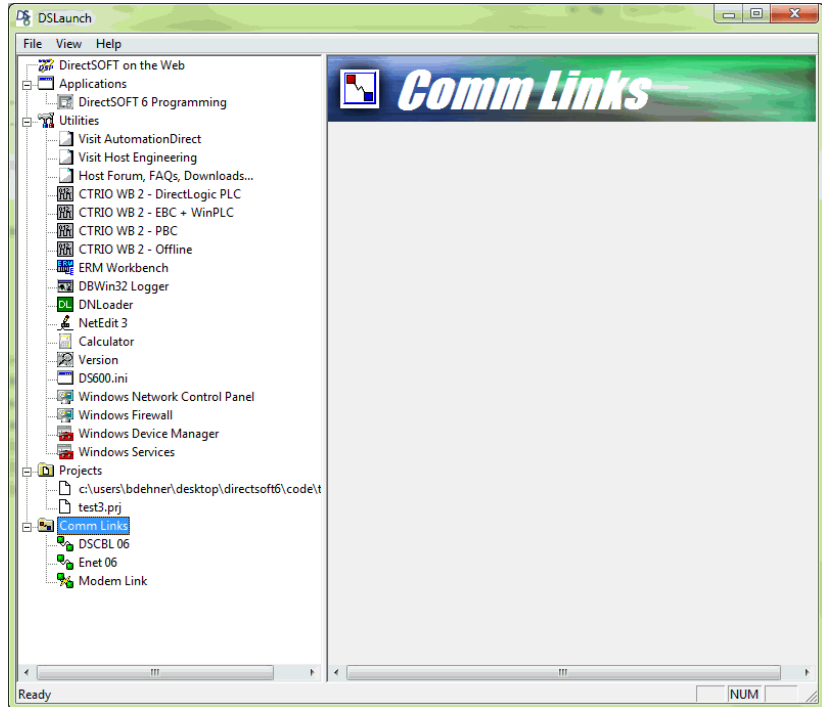

### NetEdit3 Troubleshooting Tips

As mentioned previously, when using the Hx-ECOM(xxx) module you will need to configure the IP address using NetEdit3. The module comes preconfigured to use DHCP, otherwise it defaults to address 0.0.0.0 and subnet 0.0.0.0.

If NetEdit3 doesn't see the ECOM module when you press "Scan Network", check the following:

1. Verify Link Good LEDs are illuminated on module and connecting devices like hubs or unmanaged switches.
2. Turn OFF any WiFi devices or other Ethernet devices.
3. Firewalls need to be turned OFF for initial connection (see Windows Help). Also, turn OFF any antivirus or other protection software that can interfere with Ethernet communication.
4. Try to PING the ECOM module to establish basic connection (see Windows Help, or search for resources on internet if not familiar with these steps).
5. You may need to disable any other network adapters besides the one physically connected to the ECOM or network the ECOM is on. If you get "Transport Protocol error", try the instructions in this link: <http://hosteng.com/FAQFiles/ECOM.htm#FAQ0024> Go to Step 4, Item C. The latest version of NetEdit has the ability to select the specific network adapter, by going to the main Menu, select "Network", then "Adapter" and specifying which installed adapter you want to use ( it also lists the IP addresses of the adapters). We strongly suggest you download the latest version of NetEdit here: <http://hosteng.com/SW-Products/NetEdit3.zip>
6. If you have a network administrator, you may need to check with them to verify the configuration of the local network.
7. If you have Windows XP or earlier, and you still can't make a connection, you should consider trying the IPX protocol. Click the IPX button in NetEdit3. If you get the 10047 error, you need to install the NWLink/IPX protocol to your computer Ethernet card. See Windows Help for this procedure, or try this link <http://hosteng.com/FAQFiles/ECOM.htm#FAQ0043> If you can't connect to an existing/unknown ECOM100 in a network, and the card is likely newer than 2007, by powering-down and putting dipswitch 6 ON, then powering up, the IP address will be reset to all 0's, and should become visible to NetEdit3. You must power down and turn this dip back OFF for card to be able to operate properly. <http://hosteng.com/FAQFiles/ECOM.htm#FAQ0085>



Other potential issues with ECOM modules:

- All ECOM modules need dipswitch 7 ON for IBoxes and DataWorx communications.
- ECOM modules can not be located in slot 0 of a DL205 system.

If you are trying ModbusTCP client(master) comms with an ECOM100, look at this link for the steps to follow: <http://hosteng.com/FAQFiles/ECOM.htm#FAQ0050>



---

**NOTE:** *If the ECOM100 is the slave, these steps are not required.*

---

When you have established a link to the ECOM and NetEdit can identify it, note the F and B columns. An asterisk in a column means that the firmware/booter is not the latest version (this likely won't hinder your operation, some firmware fixes are for very rare issues.) You can go to File>Live Update ( if you have an active internet connection - remember, as part of the connection you may have had to disable your internet - you can click Live Update to get the latest firmware/booter versions).

# Setup a Modem Link

Establishing modem links have changed from the standard serial link. *DirectSOFT6* uses Telephony Application Programming Interface (TAPI) for modem configurations. The TAPI protocol allows applications to control modems or other telephony devices for operations such as dialing, answering or disconnecting a connection. With the TAPI protocol, all of the modem support is centralized by the Windows operating system.

By using TAPI, the Windows modem setup utilities will be used to configure the modem. Configuring the modem in this manner should simplify the setup process and allow the selection of the most recent drivers for the modem being used.



**NOTE:** If the AutomationDirect MDM-TEL serial modem is being used, refer to the **ADC MDM-TEL Modem** setup folder on the **DirectSOFT6 CD** before trying to establish a link through the modem setup.

## Modem Setup

The first series of examples were performed in Windows 2000 and will illustrate how to configure a modem connected to your PC. The examples may differ depending on the Windows operating system being used.

1. Install the modem if not already installed. Refer to the modem's documentation for installation information. If the modem is to be used for other devices, it will need to be installed a second time.
2. Once the modem has been successfully installed, the properties will need to be edited. In the Windows **Start** field, select **Settings > Control Panel**.
3. Select **Phone and Modem Options**. A dialog with all available modems installed will appear.

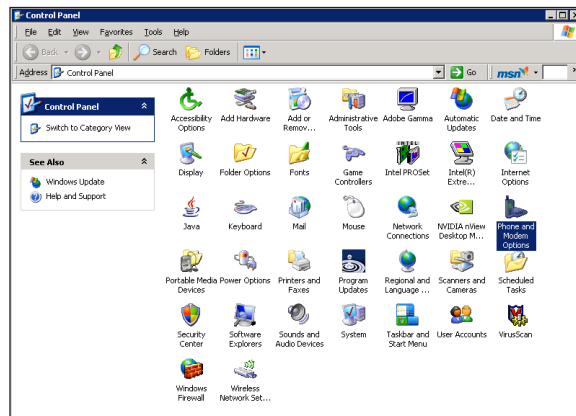

4. Choose the **Modems** tab, then click on **Properties** at the bottom.

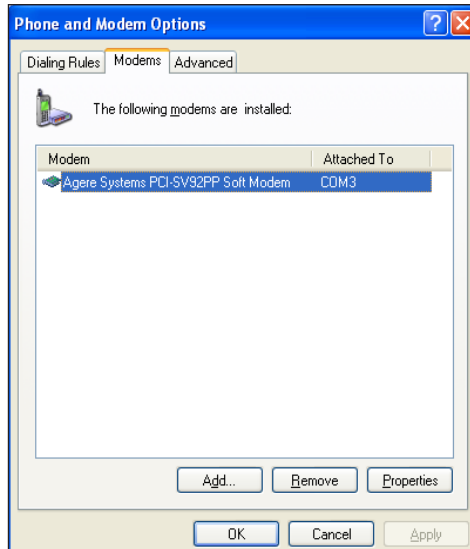

5. Choose 9600 as the **Maximum Port Speed**.

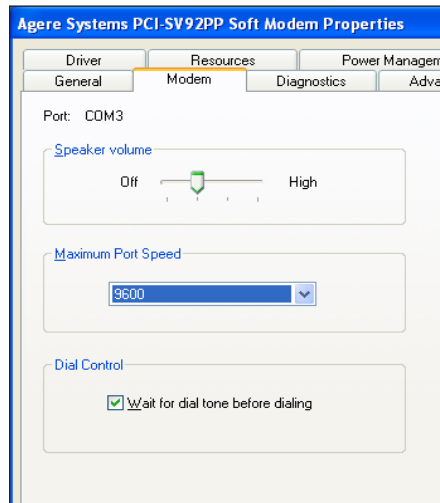

6. Select the **Advanced** tab and click on **Change Default Preferences**.

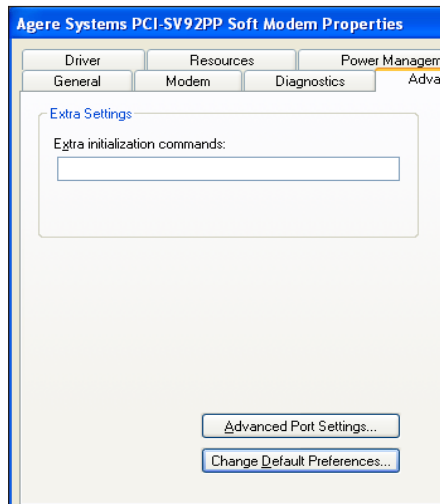

7. Make **Port speed** 9600 and choose None for **Flow Control**.

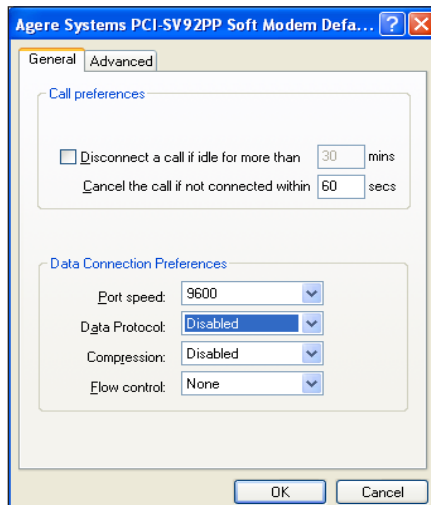

- Click on the **Advanced** tab and choose 8 **Data bits**., None for **Parity** and 1 **Stop bits**.

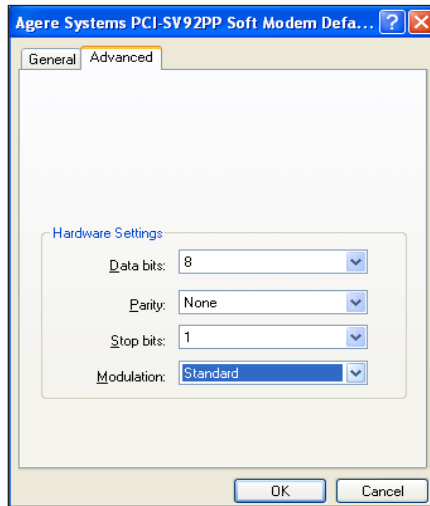

- Click **OK** until all dialogs are closed. This will setup your Windows driver so *DirectSOFT6* can use the Windows TAPI control when accessing the modem.

### Configuring the Link

With the modem configured correctly, the link to the PLC can now be established. The next series of steps will provide the information necessary for configuring the link using *DirectSOFT6*.

1. The Link Wizard can automatically determine the majority of the communication settings, however, the specific modem information (modem type, phone number, etc.) will have to be entered manually. To activate the Link Wizard in the Launch Window, right click on Comm Links in the DSLaunch tree, then select Add Link.

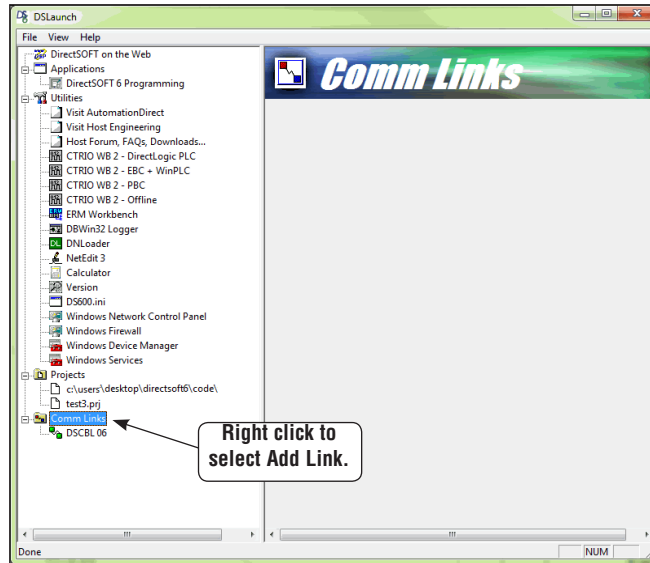

2. Select **Modem** as the device, then click the **Next** button.

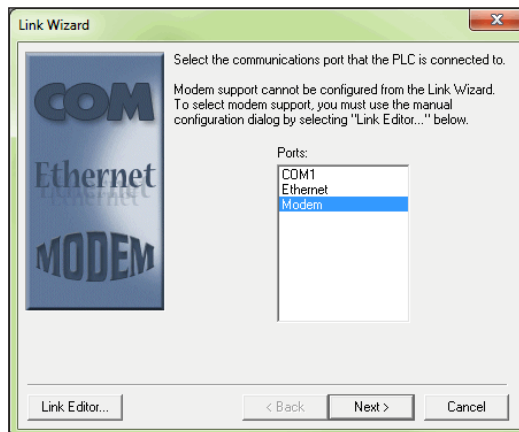

3. The **Configure Link** dialog should now be in view. First, choose the PLC family and CPU type. Click once on the appropriate **PLC Family** and a list of available CPUs for that family will appear in the **PLC Type** window for your selection. Also, give the link a name and description.

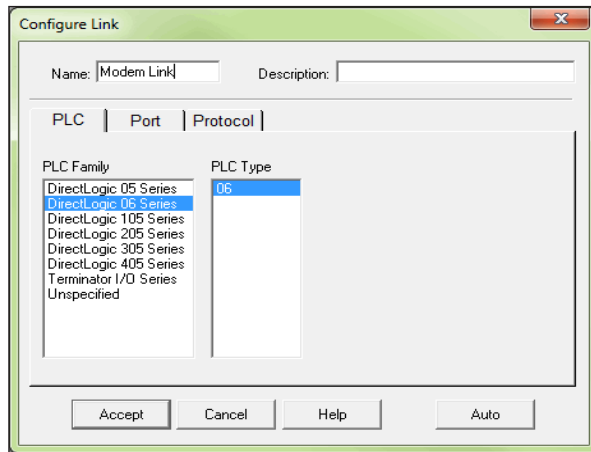

4. Click the **Port** tab on the dialog to display the port configuration dialog. This dialog is used to setup the port to match the modem's configuration. Follow the steps below:
  - a. Select Modem in the Devices column.
  - b. Select the modem type that was configured in the Windows modem setup. This can be verified or modified by clicking on the Properties button or a new modem can be setup by clicking on the Add button.
  - c. Enter the dialing information for the modem.

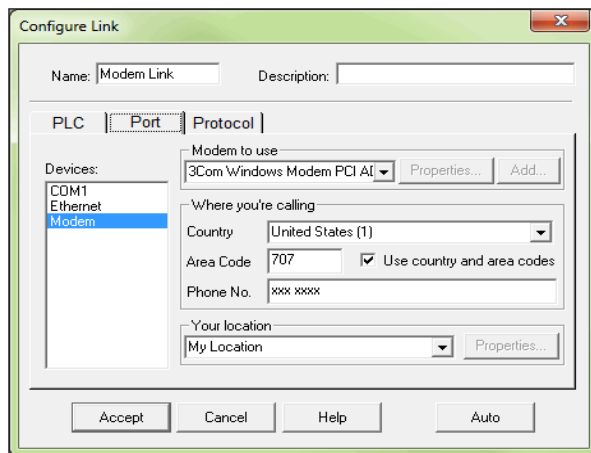

- Click the Protocol tab to display the communication protocol dialog. The communications parameters can be defined further in this dialog.

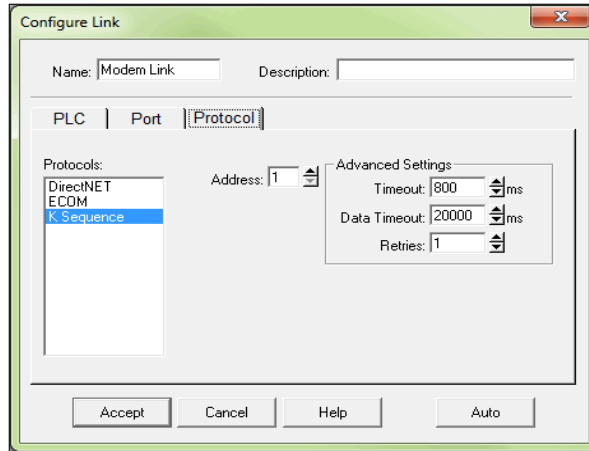

- Select the communication protocol to use. Refer to the chart in Appendix A for a breakdown of the various CPUs and which protocols are supported on which ports.
  - If the PLC has been given a node Address other than 1, enter the new address.
  - If necessary, adjust the Timeouts and Retries, however, the default values should be the best choice.
- Click the Accept button to save the link configuration. The following dialog will appear. If Yes is pressed, DirectSOFT6 will dial the modem and attempt to verify that it can indeed communicate with the PLC connected to the other modem using the defined parameters in the link. DirectSOFT6 will hangup after the connection has been made. If No is pressed, the link configuration will simply be saved to disk.

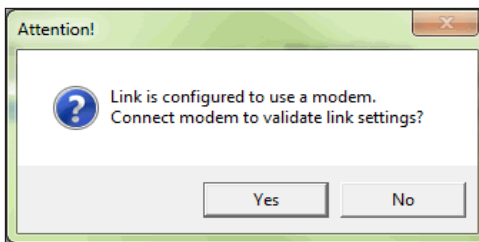



- After the link has been successfully setup, the newly configured Modem link will be listed on the DSLaunch tree under Comm Links in the DSLaunch window. The DSLaunch window will display all the information for the link whenever the link is selected.

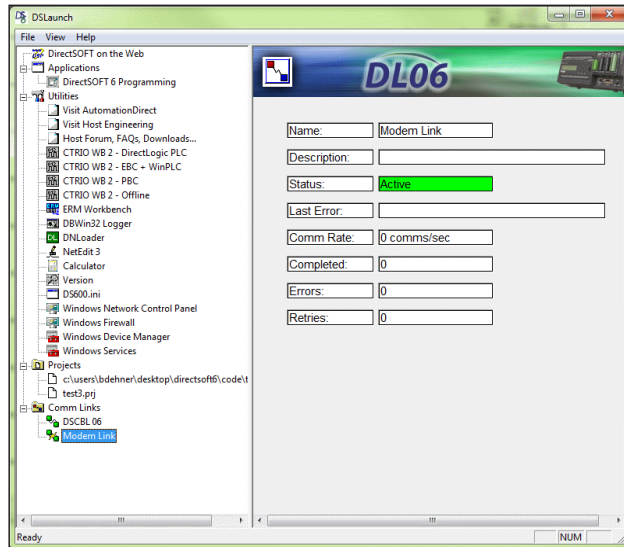

### Comm Link Options

There are several link options available after a link is setup. The link options drop-down menu is opened by right-clicking on the desired link name. The available options are shown in the menu below.

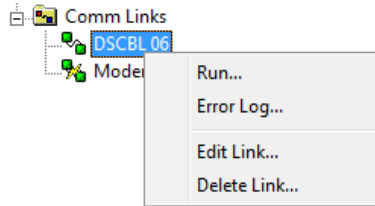

Selecting **Run** will use the link to connect to the PLC. *DirectSOFT6* will connect to the PLC and search it for a program. If a program is found in the PLC, it will be displayed in the programming window without a program name. Also, the displayed program will not have any documentation showing because the documentation is stored with the project on disk and not in the PLC.



**NOTE:** Double-clicking on the link name will also connect to the PLC.

Clicking on **Error Log...** will open the **Link Info** window displaying all communication errors which have occurred on the link along with active information for the link.

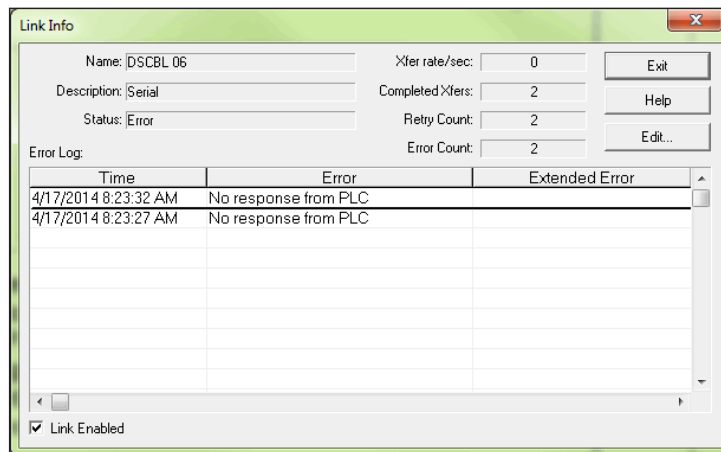

Clicking on **Edit Link...** will open the **Configure Link** dialog which was used whenever the link was setup. Click on the link to be edited, make the necessary changes then press the **Accept** button.

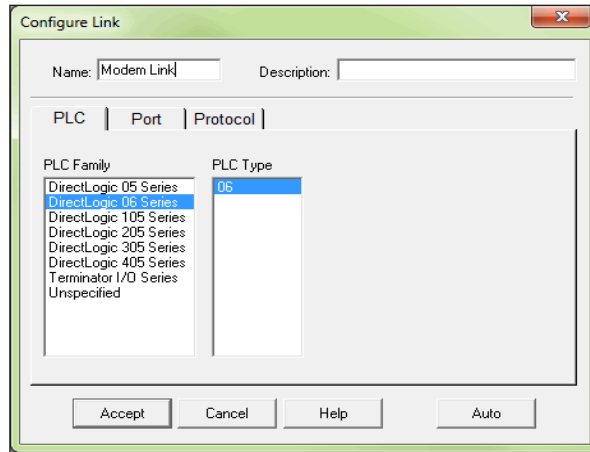

There may be a time when it becomes necessary to delete a Comm Link. To delete a link, click **Delete Link...** and the **Delete Link** dialog will open, like the one below, showing the link name and description to verify that the link is not used any longer. To delete the link, click on **Delete!**.

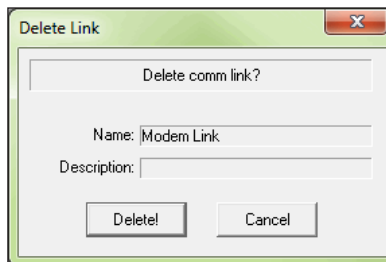

### Going Online

Once the program has been edited and the communications link has been setup, it is time to go online with the PLC and load the program.

#### Connect the PLC

With the Ladder View displayed in the Programming window, either press the **Connect** button on the PLC toolbar (if it is displayed) or use **PLC > Connect** from the Menu bar. Select the communications link from the **Select Link** dialog, then select **Use Disk** from the **Online/Offline Differences** dialog (refer to pages 2-22 to 2-24). This will load the program into the PLC. The PLC will be in the Program Mode after *DirectSOFT6* completes the download. Press the **PLC Mode** button on the Online toolbar and click on **Run** in the **PLC Modes** dialog to place the PLC online.

To disconnect from the PLC, simply press the **Disconnect** button on the PLC toolbar or use **PLC > Disconnect** from the Menu bar. Select **Yes** when asked **Are you sure?**, then you will be free to shut down.

#### Use the Project Folder

Once a project has been saved to disk, the project name will appear on the menu tree in the **Project Folder**. To open the project, double-click on its name. When the programming window is displayed, you can go online following the process just discussed.

#### Use the Link

You can also connect to the PLC by using the communications link. Make sure that a cable is connected to the PLC, then select the link name from the menu tree and double-click on it. If there is a program in the PLC, it will be displayed in the Programming window when it appears. Notice that the name of the program is **UNTITLED [Ladder View]**. The PLC does not store the program name or other documentation in its memory. All of the program documentation is stored on disk in the PC.

# DEBUGGING AND MONITORING

---



# CHAPTER 10

## In This Chapter...

Monitor with Data View .....	10-2
Change Value Dialog .....	10-16
Using the Memory Editor .....	10-20
Test Mode Operations for Debugging.....	10-22
Trap Monitor.....	10-25
Stack Monitor (D4-440 Only).....	10-28
Trend View .....	10-29
Check <i>Direct</i> SOFT6 File Revision .....	10-33

# Monitor with Data View

Chapter 2, Quick Start, described how to edit a program and go online with the PLC. There was also a discussion on how to monitor the status of the program. This chapter will discuss the monitoring and debugging features of *DirectSOFT6*.

## Using Data View

Using the Status to monitor a program is very useful. The **Data View** window is more useful since you can do much more in one view. The Data View window has more advantages, such as:

- View status of elements.
- Read and write data values.
- Multiple Data Views can be open at the same time.
- Since they “float”, they can be placed at convenient locations.
- Data View is also conveniently docked by default, and can be set to auto-hide by clicking on the push-pin. Multiple Data Views can be tabbed together as one dockable or floating window.
- Use Data View to monitor all program views (ladder, stage, mnemonic) on the same screen.
- The Data View window can be saved by name.
- Data View windows are independent of projects, and can be used for multiple projects.

## Open a New Data View Window

A new Data View window can be opened in any one of three ways; the menu bar **Debug > Data View > New**, the keyboard shortcut **Ctrl + Shift + F3** or the **Data** button on the Online toolbar.

By default, the Data View windows are assigned names **Data1**, **Data2**, etc., consecutively. This name can be changed for the current view using the Options dialog.

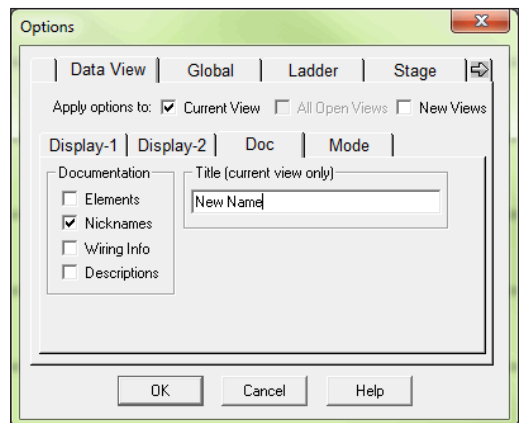

The following diagram is an example of a newly opened Data View.

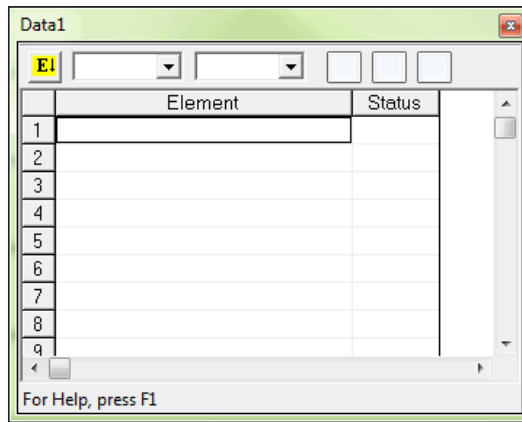

### A Closer Look

A closer look at Data View will show the basic components.

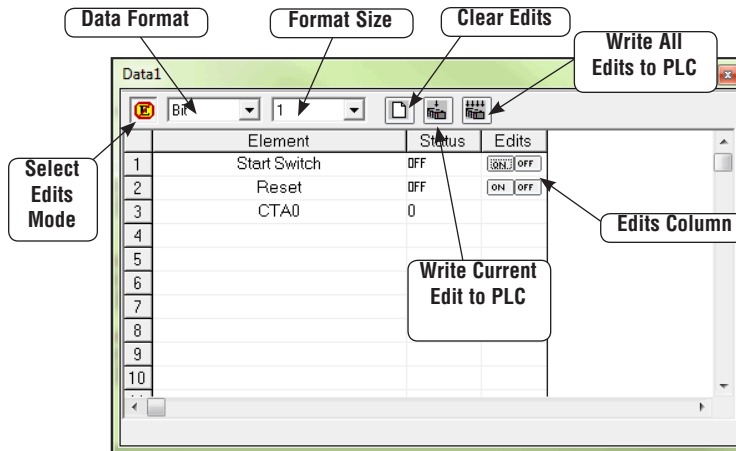

**Select Edits Mode** – enables/disables the Edits column. When the column is enabled, Edits can be written to the PLC. The Edits column is not available when disabled.

**Data Format** – change the format (bit, binary, Octal, decimal, etc.) displayed in the Status column for a selected row.

**Format Size** – choose the selected Data Format displayed in the Status column(1, 16, 32, WORD, etc.).

**Clear Edits** – this will clear all data entries from the Edits column.

**Write Current Edit to PLC** – the data value for one element can be entered in the Edits column and written to the PLC with this button.

**Write All Edits to PLC** – multiple data values can be entered in the Edits column and written to the PLC.

### Data View Options

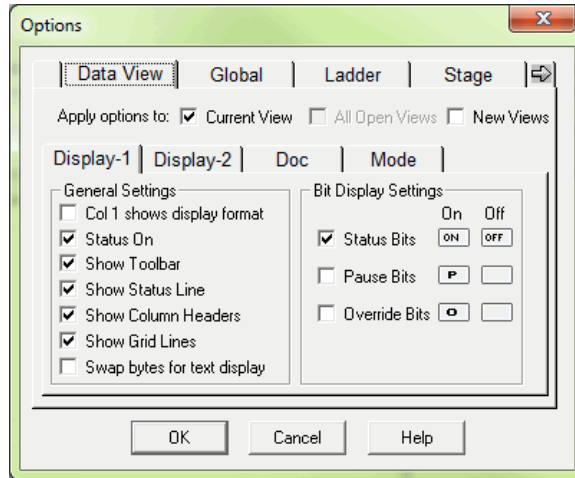

The Data View window can be customized for a particular user or users. To customize Data View, click on the Data View window, then use **View > Options** on the menu bar, press the **Options** button on the Offline toolbar or right-click in the Data View and choose Options. The Options dialog will open with the Data View tab in view as shown above.

The dialog will open with default selections checked in the **General Settings** in the **Display 1** tab. More settings are continued in the **Display 2** tab. Checking **Col 1 shows display format** may be beneficial at times. This will show the display format to the right of the element in the first column. Not all requirements are the same, and experimenting with the General Settings will determine what works best for you.



## Select Bits for Display

The **Bit Display Settings** area to the right of the General Settings, is only available under the Display 1 tab. There are three selections for controlling or monitoring bits with the PLC in the Run Mode, either one, two, all three or none can be selected (enabled).

- **Status Bits** – when this is enabled, the status of the element will be shown in the Status column if Status On is enabled.
- **Pause Bits** – enabling this will allow inputs (or other logic) to operate while disabling selected outputs.
- **Override Bits** – selected I/O points in Data View can be turned ON/OFF if this is enabled.

The diagram below shows what a Data View can look like when all three Bit Display Settings are enabled. Notice that the outputs are the only elements to have all three sets of data bit buttons in the Edits column. Each group of bit setting buttons can have the displayed indicator changed from the default to any one of twenty selections.

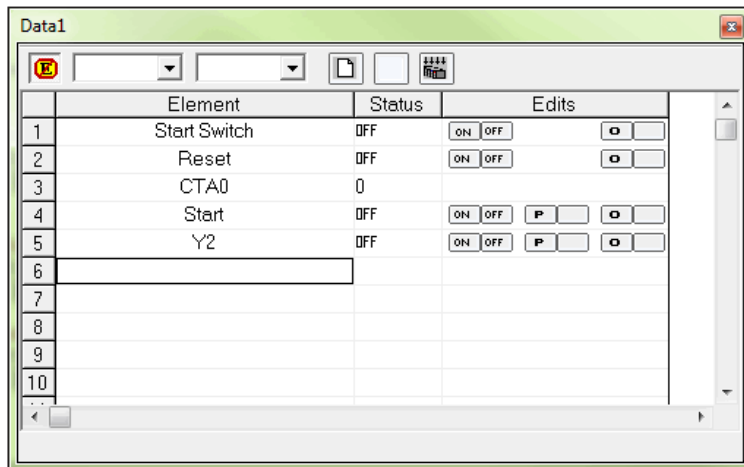

**NOTE:** The buttons in the Edits column will only be displayed when the PLC is in the Run Mode and Status is selected. Also, they will be disabled for **DirectNET** links.

Click on the Bit button to be changed and a selection window for that button will appear as shown in the diagram below. Make a selection, such as the light bulb, by clicking on it. The indicator will appear in the button and also on the Data View.

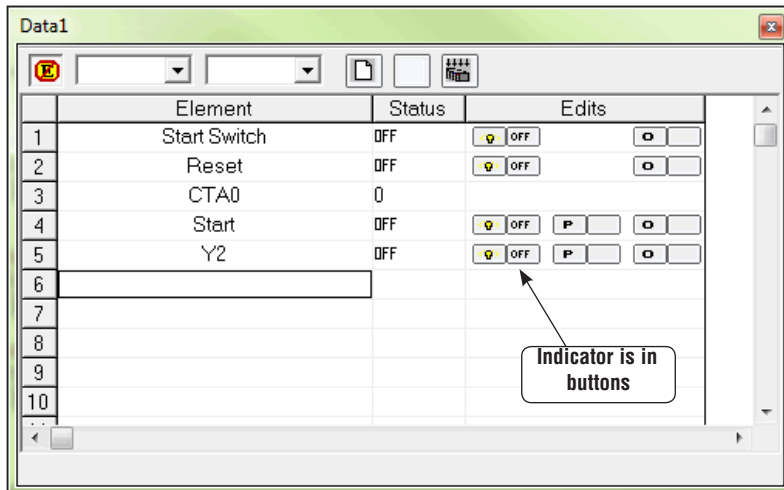
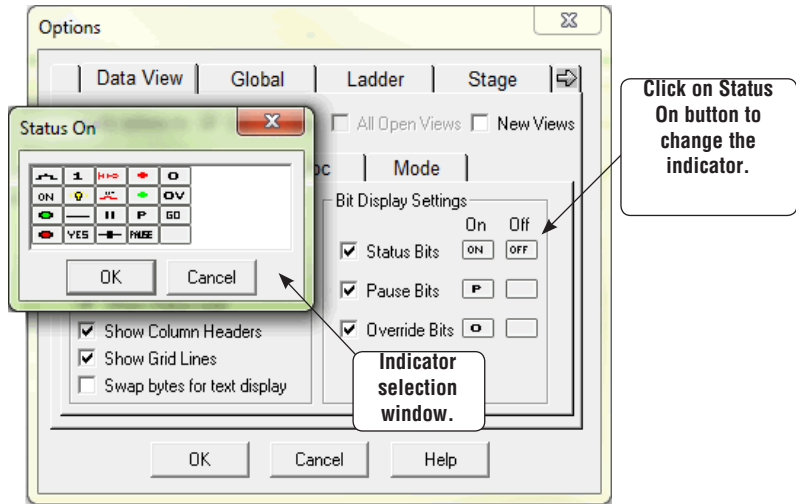

## Data View Documentation Options

Next to the Display 2 tab is the **Doc** tab. Select this tab to set up the documentation to be displayed on the Data View window. Whatever documentation (Elements, Nicknames, etc.) is to be displayed in the Element column is enabled or disabled here. The current Data View window can also be renamed from Data1, Data2, Data3, etc., to any name to better identify it. Enter the new name for the current Data View in the **Title** field. The name entered can contain up to 32 characters.

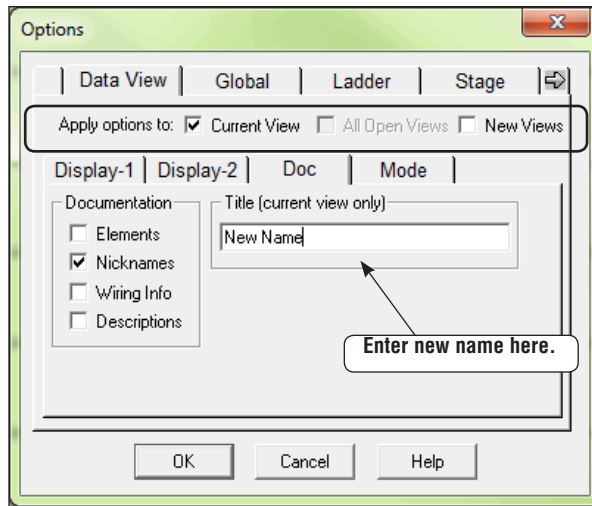

## Apply Options

Notice the three boxes next to the **Apply options to:** circled in the above diagram. These boxes are in view while the dialog is open.

Select the view the options are to be applied to when the **OK** button is pressed.

## Data View Mode Options

Next to the Doc tab is the **Mode** tab. The mode selections will determine whether the data in the Status column will be **Read Only (no writes)** or **Read/Write**. A Data View can be setup for Read Only if changes to data will not be permitted by whoever is observing it. Read/Write should be selected for monitoring and debugging a program. Leave **Safety** enabled so the write operation can be confirmed.

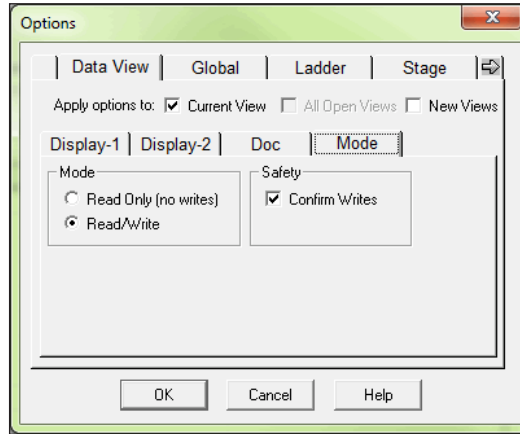

## Make Data View Entries

The columns in a new Data View window are blank whenever it is first opened. The entries are entered in the Elements column. The type of entries that can be made are element references, memory addresses or nicknames. For example, control relay C1 or Test Output 1 are valid entries. Also, R000 for a data register or V1200 for a V-memory location can be entered. The example here shows elements and a memory location which have been entered while Online with Status enabled.

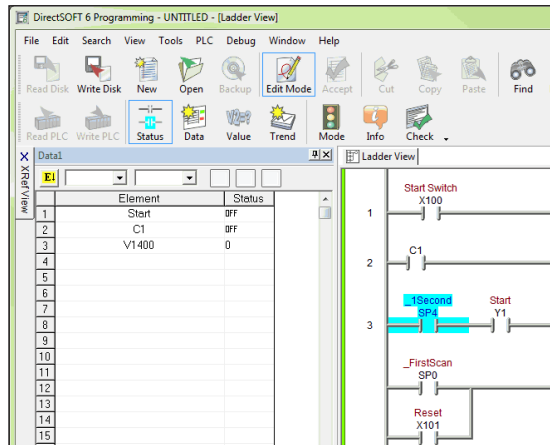

It really doesn't matter if entries are made in the Element column with the PLC Online or Offline, Status On or Status Off. Entries can be made with the PLC Offline, then it can be placed Online later to monitor the program.

Whenever a Data View window is opened, it appears to the left of the Ladder View (see the example on the facing page). Keep in mind that the Data View can be repositioned and resized to make room for a larger Ladder View like the example below. The Data View position in the example may be radical, but it may be more convenient for the user.

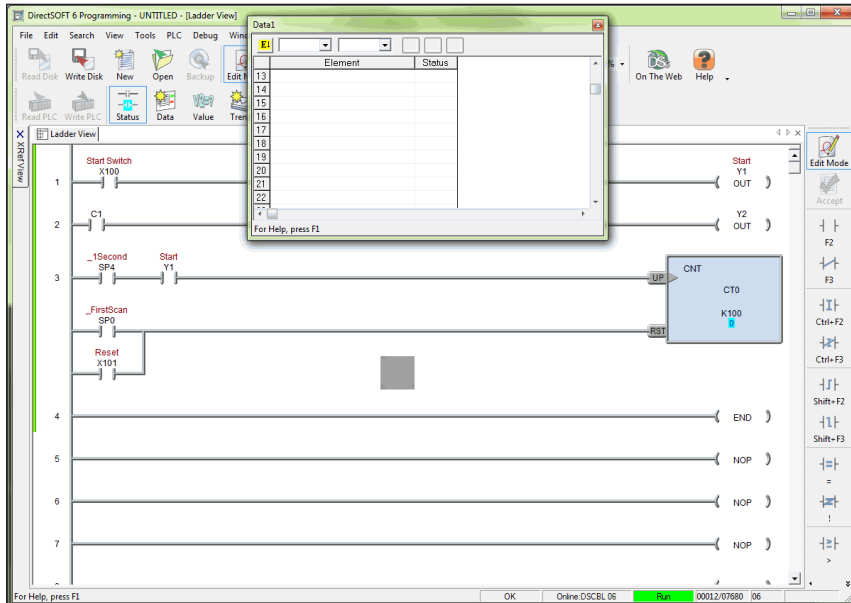

### Data Format and Size

There are two small fields located in the top left-hand corner of the Data View window. The one on the left is the **Data Format** field which displays the element type when it is selected in the Element column. If the selected element is a bit type, then Bit will be displayed in the field. If desired, Bit can be changed to Binary by clicking on the down arrow next to the field. If desired, Bit can be changed to Binary by clicking on the down arrow next to the field.

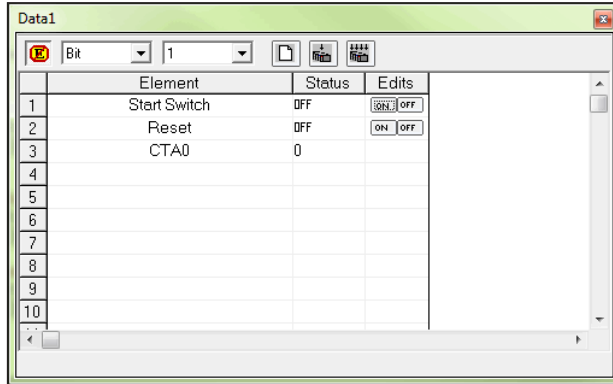

A dialog will drop down with the available selections to choose. The field to the right of the Format field is the **Data Format Size** field. The size refers to the data length. As an example, Bit is equal to 1 and Word is equal to 16 bits. The selection of the Data Format and Size is left up to the programmer monitoring the program.

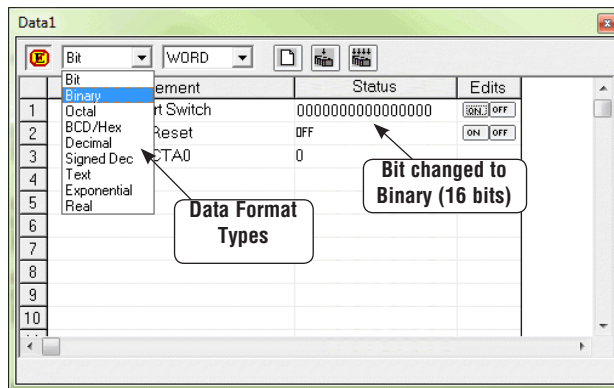

## Write the Edits

Debugging a program is not beneficial unless the user can change an element or enter data in a memory location. Changes (edits) are made in the Edits column. All of the edits are placed in a buffer prior to writing them to the PLC. There are three buttons located at the top of the Data View window which are associated with the Edits column. These buttons are pointed out in the example below. The **Clear Edits** button will clear everything out of the Edits buffer so new edits can be entered. Single edits can be entered into memory, such as a counter setpoint value. Simply enter the value in the Edits column in the counter row. A single edit can also turn on a control relay by clicking on the ON button for the relay. Once both types of entries (edits) are made, click on the button with the single arrow pointing to the PLC, **Write to PLC**. Multiple values or control relays can also be written to the PLC. The entries or ON buttons are selected as for the single edit. After the edits are made, click on the button with four arrows pointing down at the PLC. The edits will be written to the PLC one at a time.

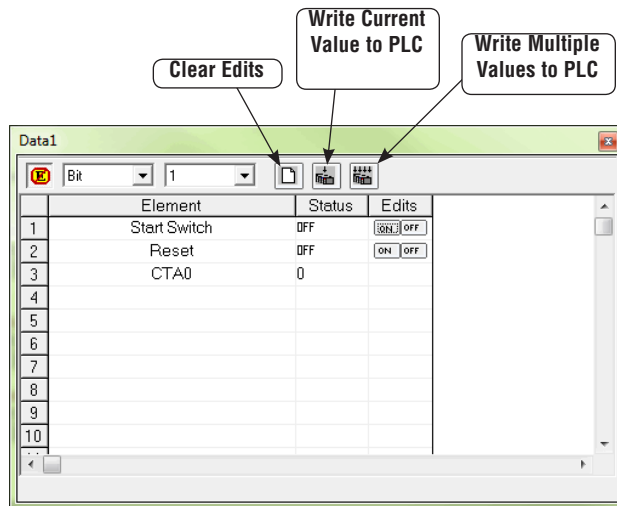

**WARNING:** I/O points can be turned on by using the Override buttons. Caution must be taken when forcing I/O to prevent accidental harm to personnel and equipment.

### Auto-increment

Auto-increment is a feature that can be used to enter elements sequentially. For instance, if a group of control relays, C10, C11, C12 and C13 are to be monitored, enter C10 then click on it again, and then hold down **Ctrl + Enter** and control relays will be entered until the **Enter** key is released. If there is an element that has been entered previously in Data View, click on the element nickname or reference, then use the **Ctrl + Enter** keys as mentioned above. The elements will be entered in sequence below the starting point and any elements that were below the start point will be pushed down below that point.

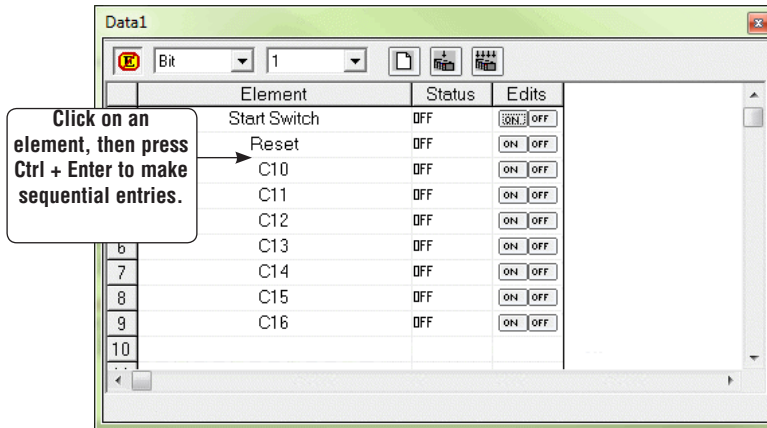

### Editing Entries

Editing the entries can only be accomplished by using the standard keyboard shortcuts. Click on the element to be edited, then use either **Ctrl + C** or **Ctrl + X** to copy or cut the element. **Ctrl + V** is used to paste the element.



**WARNING:** Because Data View follows the conventions of spreadsheet pasting, be aware that the pasting operation will overwrite any field that has been selected prior to the paste. Consequently, it is preferred to paste the data into an empty field.

Elements can be deleted from a Data View at any time. Select the item by clicking on it, then either use the **Delete** key, **Edit > Delete**, the **Delete** button on the Edit toolbar or right-clicking on the element then select **Delete** in the pop-up menu. The deleted elements are not placed on the clipboard, therefore lost.



An editing feature that can be useful is the ability to select more than one item in Data View by using the method used to select rungs in the Ladder View. Select the first item in the group, then use the **Shift + Arrow** keys to mark a range of items either horizontally or vertically. A more simple way to mark items is to click on the first item in the range, and hold the button and drag the mouse arrow over the rest of the last item to mark. The marked items can then be deleted, cut, copied or you can change the Data Format or Data Size of the selected items all to the same format or size.

### Save the Data View Window

Once the Data View window has been setup for debugging and monitoring a program, it is a good idea to save it so it can be opened and used later. If the **Debug** toolbar is displayed, click on the **Save** button and the **Save** dialog will open. The Data View can be named something else instead of the default (Data1, Data2, etc.), then save the Data View to the Projects folder by clicking on the **Save** button. The Save dialog can also be opened by using **Debug > Data View > Save** from the Menu bar. If a duplicate Data View is needed, either use the **Save As** button on the Debug toolbar or **Debug > Data View > Save As** from the Menu bar.

## Using Pause Bits

A Pause Bit can be set for each output in the Data View window. By setting the Pause Bit, the output status can be controlled when the PLC transitions from Test Run to Test Program. The ability to hold output states is useful, since it allows key system I/O points to be maintained.

The Pause Bit is set to maintain the output status, and the Pause Bit is turned off to allow the PLC to turn off the output on the transition to Test Program mode.

The Pause Bit option is selected for outputs in the Data View Options tab as seen below. The On/Off Pause buttons will then show on the Data View.

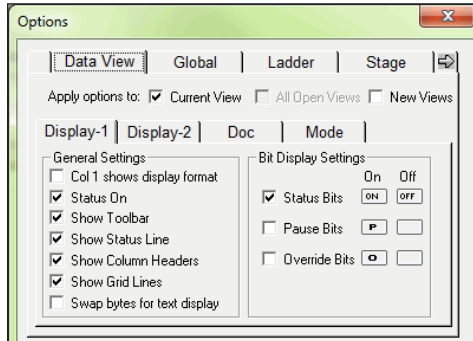

To set the Pause Bit for an output, click on the respective pause button (letter P). Click on the blank button to turn the pause feature Off. When in the Off mode, the Pause Bit is not set and the output will turn off on the transition to Test Program. The letter 'P' in the Status column indicates the Pause Bit is set for that output.

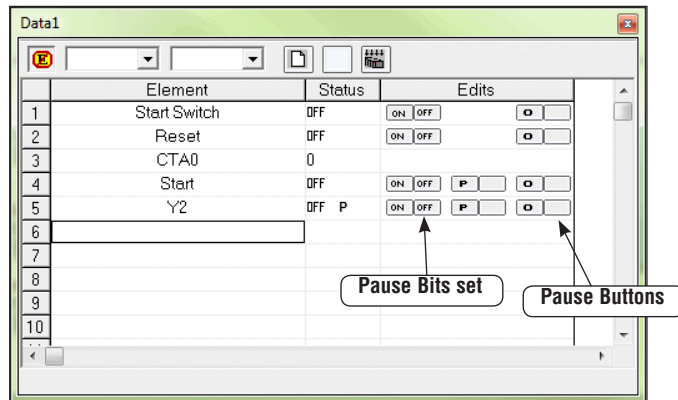

## Use Override Bits to Control I/O

(DL05, DL06, D2-240, D2-250-1, D2-260, D2-262, D3-350, D4-450, D4-454)

If your PLC supports **Override Bits**, they can be set for each input and output using Data View. Setting these bits allows the status of the input or output to be controlled by a programming device instead of the field device wired to the I/O module. It is similar to forcing an I/O ON or OFF.

To use the Override Bits, they must be enabled in the Data View Options dialog. Select Override Bits just like the Pause Bits were selected. Click on the **Select Mode** button at the top of the Data View window to view the Override Bits buttons. Expand the Data View window if necessary so the buttons will show.

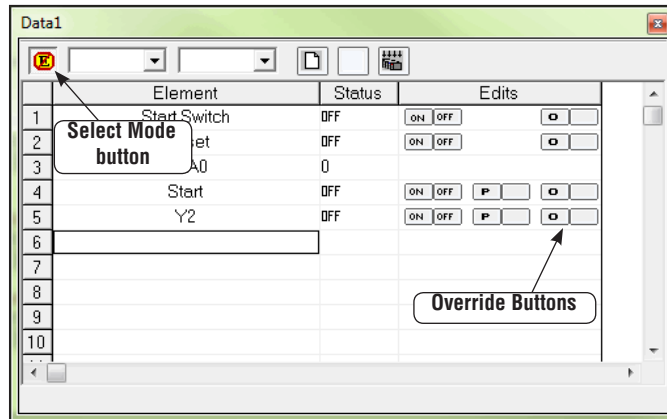

To set an Override Bit for an I/O point, click on the respective Override button with the letter 'O'. Clicking on the blank button will turn the Override feature Off. The letter 'O' in the status column indicates the Override Bit is set for that I/O point.



**NOTE:** Override bits clear out on a Program to Run transition.

## Change Value Dialog



**WARNING:** Only authorized personnel should make changes to the program elements or data values. Changes made while the PLC is in Run Mode become effective immediately. Thoroughly consider the impact of making changes in order to minimize the risk of personal injury or damage to equipment.

The Data View window can be used to make dynamic changes to I/O and change data values stored in memory. The status of an I/O point is performed by using the dynamic edit buttons, and the data values are changed by typing new values in the Edit column. Both types of edit take effect only when they are written to the PLC.

### Use the Change Value Dialog

Turning On/Off I/O points (only with Override bits set) and writing data values to memory locations can also be accomplished by using the **Change Value** dialog. When using this dialog, it is not necessary to have Status on to make changes to the PLC, but it is a good idea to be able to see the changes when they are made.

To open the Change Value dialog, either press the **Change Value** button located on the Online toolbar, use **Ctrl + Shift + F2** or, with Status on and not in the Edit mode, double click on the element to change. The following dialog will appear.

The dialog will open with either a default reference or the reference that was double-clicked on showing in the **Element** window.

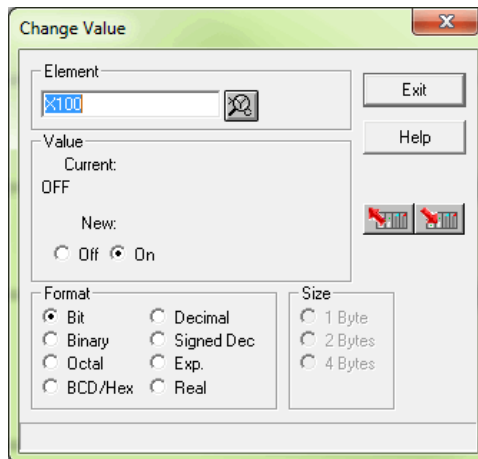

## Specify an Element Reference or Nickname

Since nicknames and element references are used when editing a program, they can also be used with the Change Value dialog. If an element with a nickname is enabled in the program when the dialog is opened, the nickname will appear in the Element field. An element does not need to be enabled to open the Change Value dialog. If the default reference (C0) is displayed when

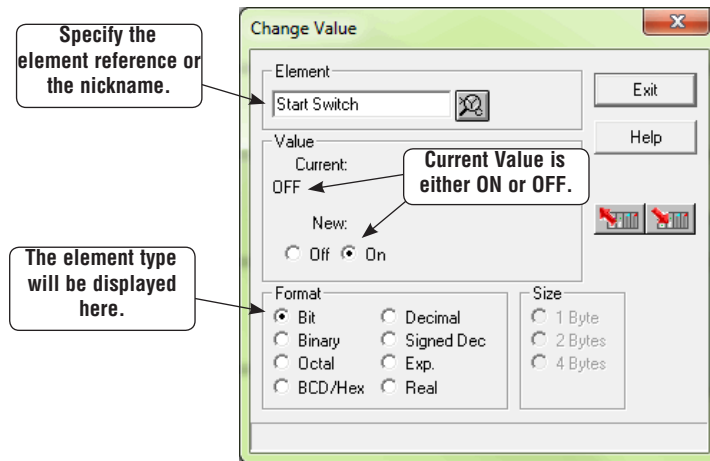

the dialog is opened, either type in the element reference or the nickname that is to be changed. The dialog will always open with the **Current Value** displayed. The displayed element will either be On or Off. The Current Value can also be a memory location. (See below).

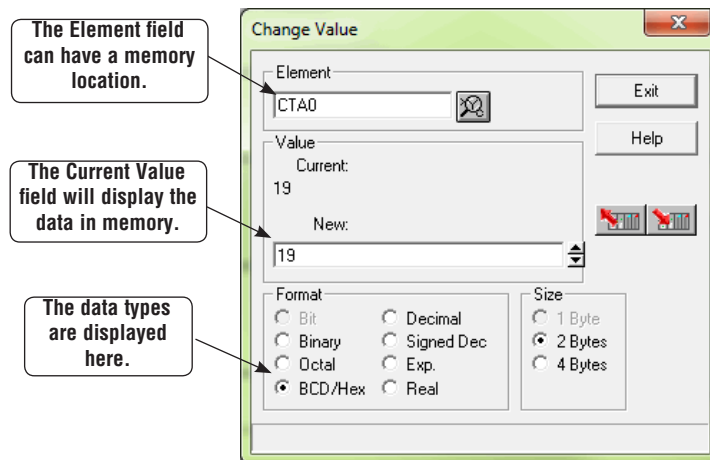

### Enter a New Value

To change the state (value) of a bit data type, such as a control relay, enter the reference or nickname. The example diagram below has C1 entered in the Element field. To change it from Off to On, simply click the On under **New**. Like Data View, the new state will not be written to the PLC until it is told to. Do this by pressing the **Write to PLC** button. The Current Value will change to read On.

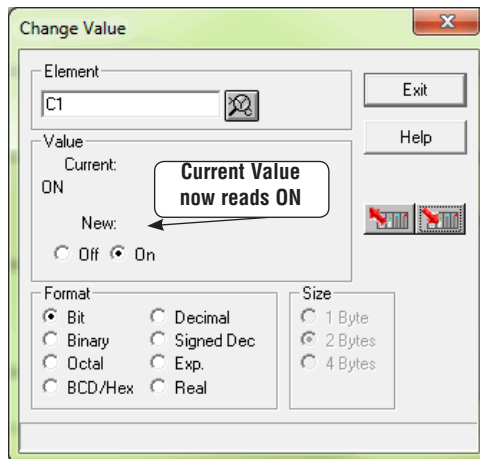
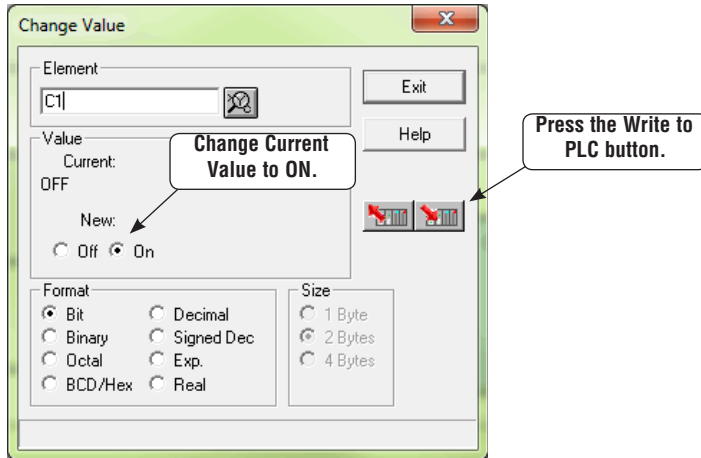

**NOTE:** To force I/O, use the Override editor.

To write to a V-memory location, type the memory location in the Element field. The value in memory will appear in the current value view. To change the value, enter it in the **New** field, then press the Write to PLC button. The new value is written to the V-memory location. The value in the memory location will be displayed under **Current Value**.

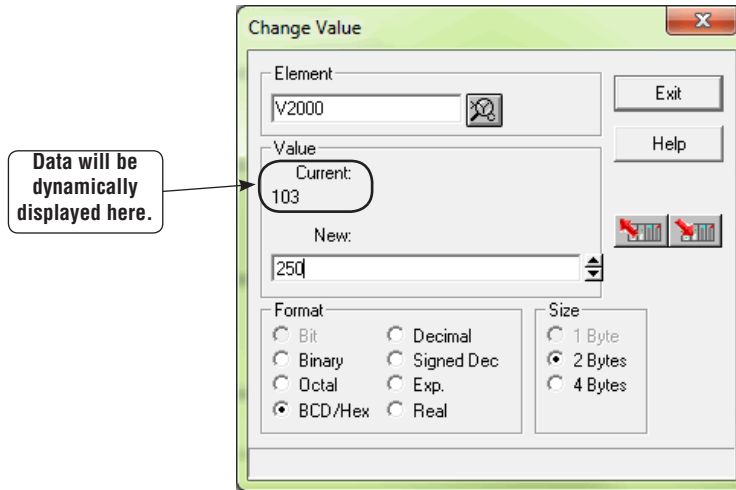

When an I/O reference or a memory location is entered in the Element field, the status or value will be displayed in the New value field as well as under the Current Value. By clicking on the **Read from PLC** button, the Current Value and the New field will be updated with the current status or data.

## Using the Memory Editor



**WARNING:** Only authorized personnel should make changes to the program elements or data values. Changes made while the PLC is in Run Mode become effective immediately. Thoroughly consider the impact of making changes in order to minimize the risk of personal injury or damage to equipment.

Another debugging tool which *DirectSOFT6* features is the **Memory Editor**. The Memory Editor can be used to view and change data in a multiple of memory locations. This is especially helpful for:

- Entering or changing values in V-memory or Data Registers for use as constants, timer/counter presets, etc.
- Entering text strings into a block of V-memory or Data Registers.

Either press the Memory Editor (**Memory**) button located on the Tools toolbar, use **Tools > Memory Editor** on the Menu bar or use the keyboard shortcut, **Ctrl + Y**. The following diagram is an example of the Memory Editor.

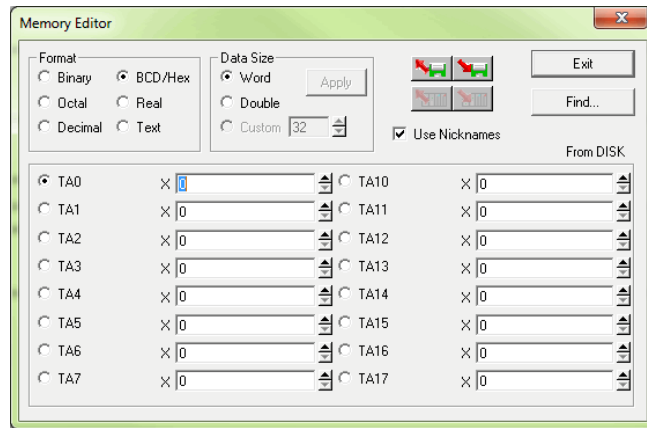

### Select the Locations to View

To use the Memory Editor, first use the **Find** button located in the upper right-hand corner of the editor. A dialog will appear for the entry of the memory address to begin the range to be viewed or edited and press **OK**.



**NOTE:** The Memory Editor cannot be used to access bit registers (I/O as registers or V-memory). For example, R600 is entered to access Timer 600 in a DL305 system, or V1000 to access Counter 0 actual value in a DL05 PLC.



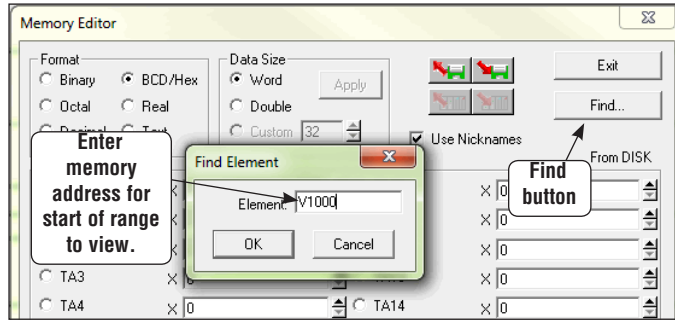

Entering V1000 for the memory range will display the alias CTA0. The alias could have also been entered. Notice the **Format** area where the default, BCD/Hex, has been automatically selected. This is the proper format for the actual counter value. If the user wishes to view it in a different format, simply click on one of the formats shown to change the default. Also, the data size can be selected in the same manner. How the data is viewed is strictly up to the user. Any one of the sixteen data fields can be selected to enter data. Once new data is entered in the data field, press the **Write to PLC** button to update the PLC. The Memory Editor will not update the data being viewed automatically. To view data being updated, press the **Read from PLC** button. Press this button each time you wish to view data being updated.

There may be times when a block of memory will be need to be setup with data and saved for use during debugging. Simply enter the data in each data field to be written to the PLC. After entering the data, press the **Write to Disk** button to save the data. Use the **Read from Disk** to re-enter the data in memory.

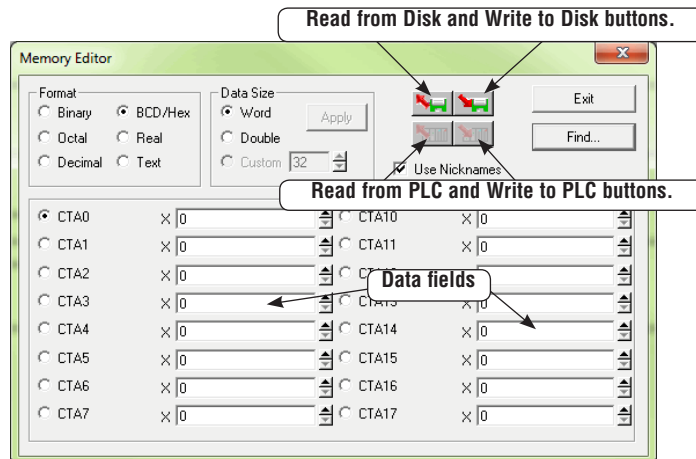

## Test Mode Operations for Debugging

### Select Test Mode

*Direct*LOGIC PLCs support most **Test Mode** operations which *Direct*SOFT6 features (only the D4-440, D4-450 and D4-454 support all Test Mode operations). Test Mode operations can be a useful tool for debugging programs. Have Status on when using the Test Mode feature to assist with debugging your program. Enter the Test Mode from either the Run Mode or Program Mode, by either pressing the **Mode** button on the Online toolbar, using **PLC > PLC Modes** on the Menu bar or using the keyboard shortcut **Ctrl + Shift + R**. The **PLC Modes** window shown below will appear. Select **Test** then **OK**.

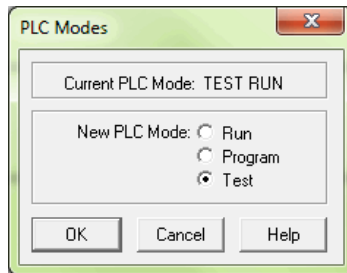

If the PLC is in the Run Mode when Test is selected, the CPU will still be scanning the program and **Test RUN** will be displayed in the PLC Mode Indicator at the bottom of the program display window.

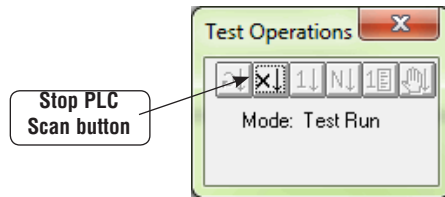

To use the Test Operations, open the **Test Operations** window by selecting the **Test** button from the **Debug** toolbar. The PLC must be in the **Test Program Mode**. The PLC can be placed in the Test Program Mode from the above window by clicking on the **Stop PLC Scan** button which will be the only button highlighted in the window when in Test Run. The Test Program Mode can also be entered from the **Program Mode** by opening the PLC Modes window and selecting Test.

## Test Program Operations

There are four operations available for all *Direct*LOGIC PLCs in the Test mode only:

1. **Start PLC Scan** – this places the PLC into the Test Run mode and will start the execution of the PLC. The PLC will continue executing until the **Stop PLC Scan** button is pressed.
2. **Stop PLC Scan** – this places the PLC into the Test Program mode which will stop the execution of the PLC.
3. **Single Scan** – will start the execution of the PLC program for one scan, and then stop execution of the program.
4. **Multiple Scans** – is used to execute the PLC program for a given number of scans. Enter the number of scans in the entry field of the pop-up window, and press OK. The PLC will change to Test Run mode until the given number of scans have been executed at which time the PLC will change to Test Program mode.

Two additional Test Operations are only available for the D4-440, D4-450 and D4-454 PLCs, they are:

**Breakpoint** – specify an instruction address at which to stop the PLC. Pressing OK will execute the program until it reaches the address, and then the PLC is placed into Halt Mode.

Breakpoint will place the PLC into Test Run mode until the specified address is executed, then returns the PLC to Test Halt mode.

**BREAK Instruction** – this instruction changes the operational mode of the CPU from Run to the Test Program mode. The Break instruction allows V-memory and image register data to be retained where it would normally be cleared with the STOP instruction or a normal Run to Program transition. (See the DL405 User Manual or the D4-454-M manual).

### The Test Operations Window

The Test Operations window can be opened with the **Test** button located on the Debug toolbar or by using **Debug > Test Mode Operations** from the Menu bar, and the following window will appear. The window has six buttons to be used for Test Operations mentioned on the previous page. The buttons available for each test mode will be highlighted. Only one button, Stop PLC Scan is available in Test Run, and two buttons are only available for use with the D4-440, D4-450, and D4-454 PLCs, Single Step and Breakpoint.

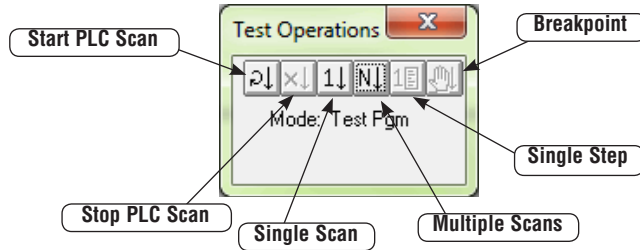

## Trap Monitor

### Access the Trap Monitor

The DL06, D2-250-1, D2-260, D2-262, D4-450 and D4-454 uses an additional diagnostic tool called a **Trap Monitor**. The Trap Monitor is used to trap (capture) element data at a specific address rather than after a scan. The Trap Monitor can be a useful tool if you wish to look at some ladder logic in the Test Run mode. An example might be to check a math routine to see if it is working properly.

To use the Trap Monitor, either press the **Trap** button located on the Debug toolbar, if it is displayed, or use **Debug > Trap Monitor** on the Menu bar. The Trap Monitor can only be used in the Test Run Mode. If the PLC is not in Test Run, a message will appear to ask you if it is safe to switch the PLC to Test Run mode. Select the “Switch to....” button. Another dialog will appear and ask if you are sure it’s okay to switch to Test Run. Once the PLC is placed in Test Run, the dialog shown below will appear. A definition of the basic components will be helpful before using the Trap Monitor.

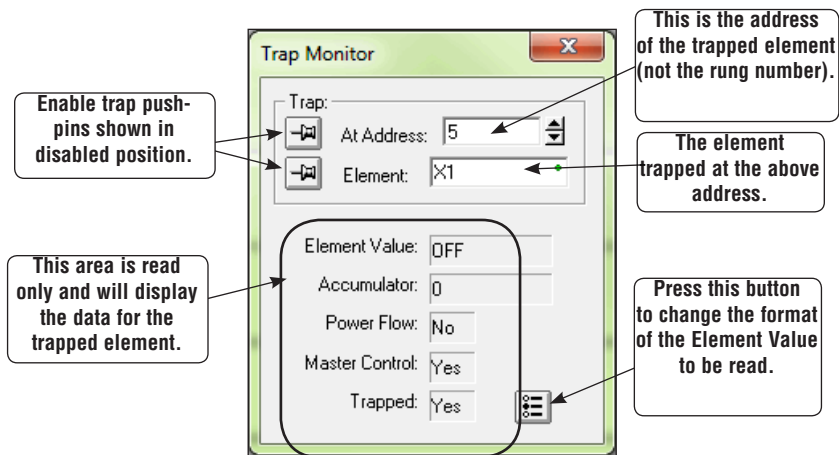

The Trap Monitor can be used as shown above by entering the element address and the element reference to read the data in the read only area of the dialog. The address can be left alone while the element reference is being changed if it is necessary to read the Element Value at that address. Or, the Address can be incremented or decremented leaving the Element Value alone to check the data at different addresses.

Another way to use the Trap Monitor is to enable the two Trap push-pins. When the pins are enabled, the Address can be incremented or decremented while observing the Element located at the new Address. The read-only data will also change.



If you want to “step” through a program area to check the data in V-memory locations, just leave the Trap Monitor dialog as shown above, then place the ladder program cursor over the element (box) with the memory reference in it. You can then read the data in the read only area.

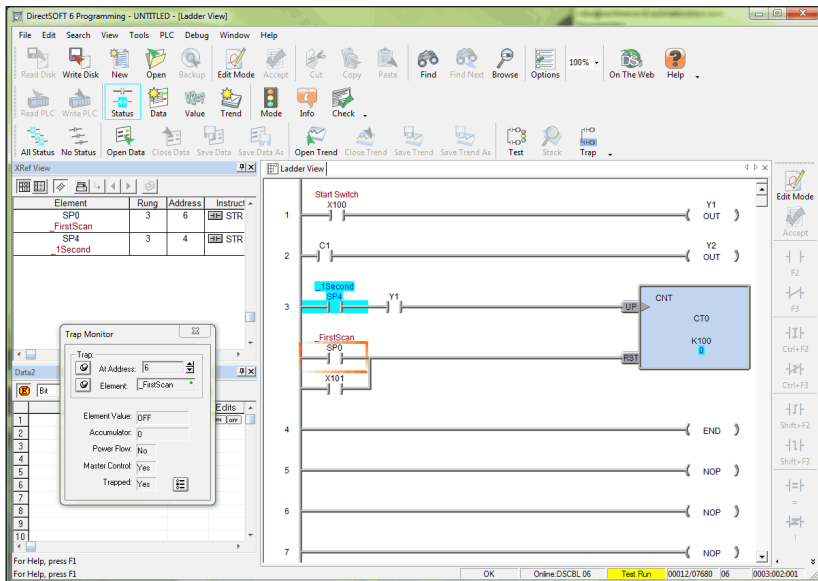

## Use with Data View

The Trap Monitor is normally used in combination with one or more Data Views so the inputs and outputs of the Ladder Logic or Stage program can be controlled. The Trap Monitor is useful to look at math operations in a program. The format for the values being read can be specified (Decimal, Hex or Octal). Press the button in the lower right-hand corner of the dialog to open another dialog to set the format.

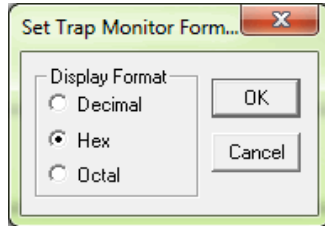

---

**NOTE:** The Trap Monitor feature is not available to use with the DL05.

---

## Stack Monitor (D4-440 Only)

### Access the Stack Monitor

The Stack Monitor monitors PLC accumulator and data stack. Either use the **Debug->Test Mode Operations->Breakpoint** dialog or the BREAK instruction to monitor the PLC accumulator and data stack at a specific address.

Access the **Stack Monitor** by either pressing the **Stack** button located on the Debug toolbar or by selecting **Debug > Stack Monitor** from the Menu bar. This feature is used most frequently with segments of programming which require debugging math operations.



## Trend View

As mentioned in Chapter 7, Trend View is used to visually monitor the values of *Direct*LOGIC controller data elements over time. The Trend View can monitor any readable numeric location or any readable bit location or any constant value.

The Trend View logs the values of the controller elements on each pane of the Trend. Those values are displayed on a moving graph. The Trend View also provides a historical mode which lets the programmer view all of the data that is currently stored for each of the data points on the display. The logged data values can also be exported to a CSV file for importing into a third-party application for further research.

A new (empty) Trend View can be created by selecting **Debug > Trend View > New** from the Menu, or clicking the **Trend** button on the Online toolbar. Enter the number of Panes in the Number of Panes field or use the Up or Down arrow to set the value. Click the OK button to accept or the Cancel button to abort.



**NOTE:** Refer to the *DirectSOFT6* help file for more information on configuration options and features of Trend View.

### Using the Trend View

Once a Trend View has been created and its display options have been configured, the Trend will begin collecting data for each of the controller elements on each of the panes and displaying the data in graphical form as seen below.

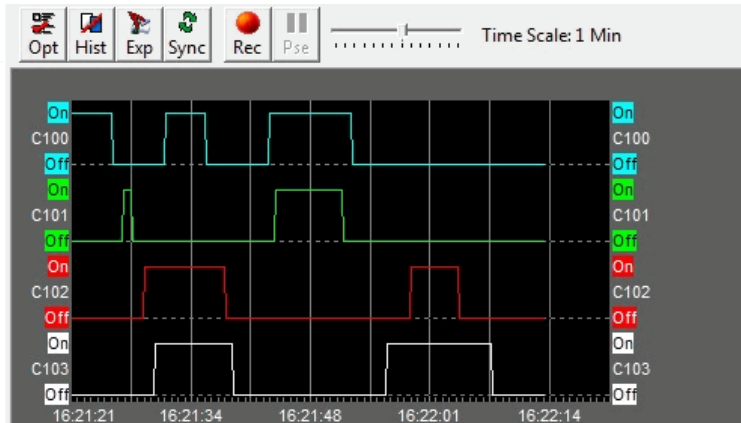

Some things to be aware of when using Trend Views:

- Discrete points, integer values and real values are placed in separate panes.
- Variables are graphed using solid lines.
- Constants are graphed using dotted horizontal lines.
- Red vertical lines indicate a loss of communication.
- Blue vertical lines indicate communication is re-established.

### The Crosshair Cursor

The crosshair cursor is displayed anytime the mouse cursor moves over any of the panes in a Trend View. The crosshair provides a visual reference when comparing values displayed on the Panes of a Trend. If there are multiple Panes in the Trend View, the vertical bar of the crosshair will extend through all of them.

Using the CTRL key and the scroll wheel on the mouse will put the Trend View into Historical Mode and zoom into or out of the area under the center of the crosshair as follows:

- CTRL + scrolling upward will zoom into the area by decreasing the Time Scale
- CTRL + scrolling downward will zoom out of the area by increasing the Time Scale.

Left-clicking the mouse will take a snapshot of all the values on all the Panes on the Trend at the time where the crosshair was located, then present the data on a snapshot dialog.

Clicking the Copy Contents to Clipboard button will copy the data displayed on the snapshot dialog to the Windows clipboard, which can then be pasted into any other Windows application for further processing.

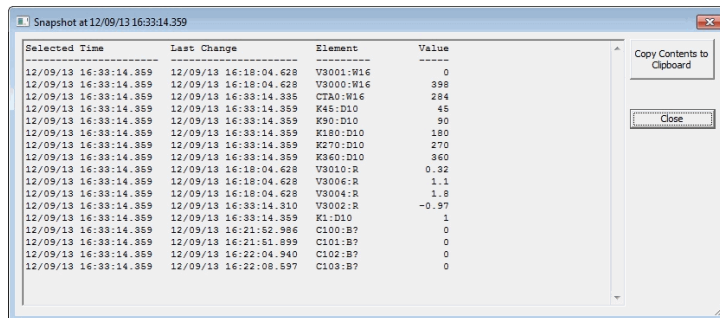

Selected Time	Last Change	Element	Value
12/09/13 16:33:14.359	12/09/13 16:18:04.628	V9001:W16	0
12/09/13 16:33:14.359	12/09/13 16:18:04.628	V9000:W16	398
12/09/13 16:33:14.359	12/09/13 16:33:14.359	C10:W16	284
12/09/13 16:33:14.359	12/09/13 16:33:14.359	K45:D10	45
12/09/13 16:33:14.359	12/09/13 16:33:14.359	K90:D10	90
12/09/13 16:33:14.359	12/09/13 16:33:14.359	K180:D10	180
12/09/13 16:33:14.359	12/09/13 16:33:14.359	K270:D10	270
12/09/13 16:33:14.359	12/09/13 16:33:14.359	K360:D10	360
12/09/13 16:33:14.359	12/09/13 16:18:04.628	V9010:R	0.32
12/09/13 16:33:14.359	12/09/13 16:18:04.628	V9006:R	1.1
12/09/13 16:33:14.359	12/09/13 16:18:04.628	V9004:R	1.8
12/09/13 16:33:14.359	12/09/13 16:33:14.310	V9002:R	-0.97
12/09/13 16:33:14.359	12/09/13 16:33:14.359	K1:D10	1
12/09/13 16:33:14.359	12/09/13 16:21:52.986	C100:BP	0
12/09/13 16:33:14.359	12/09/13 16:21:51.999	C101:BP	0
12/09/13 16:33:14.359	12/09/13 16:22:04.940	C102:BP	0
12/09/13 16:33:14.359	12/09/13 16:22:08.997	C103:BP	0

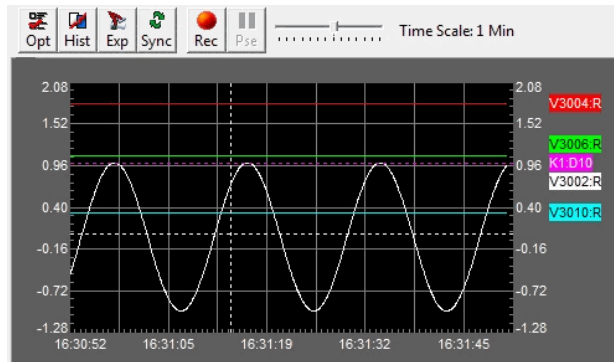

Looking at the above Trend View, notice the following menu options at the top of the View.



- Trend View Options - opens the Trend View Options dialog to specify the controller elements that will be included in the Trend and to choose how those elements will be displayed on the Trend. When this button is clicked, the last pane that had focus will be selected (highlighted) when the Trend View Options menu comes up.



- Toggle Historical Mode - stops the real-time (live) update of the trend displays and adds a scroll bar to the bottom of the trend panel that allows the user to scroll backwards in time through all of the data that is currently stored for each of the data points on the displays. The data gathering for each data point on the trend displays will continue while the Trend View is in historical mode. When the Trend View is in historical mode the tab name will have the word [HISTORICAL] added to it. Clicking the button again will re-enable the real-time (live) update of the trend displays and the trend graphs will be updated with all of the data that was gathered while the displays were in historical mode.



- Export Range - is used to export the values that are currently stored for each data point on the trend. All of the accumulated data points or only the data points between two user-selected time stamps can be exported.



- Synchronize with Other Trend Views - is used to synchronize the time frame and the starting time stamp of multiple Trend Views so that all synchronized views will display the same start time and the same amount of time. Click the Sync button to display a list of the available Trend Views. Select the Views from the list that are to be synchronized with the current view then click the Synchronize button.



- Begin Recording - click this button to begin the recording session. The button face will change from a red circle to a black square with Stop as its new name and the word [RECORDING] will be displayed in the dialog's tab. Clicking this button again will stop the recording and a Save As dialog will prompt for the filename in which to save the recorded data.



- Pause Recording - stops recording data while the button is depressed. The button will appear depressed and the word [RECORDING - PAUSED] will be displayed in the dialog's tab. Click the button again to continue recording data or click the Cancel button to stop the recording session completely.
- Time Scale - sets the overall amount of time to be displayed in all of the panes. The Time Scale can be set to the following:

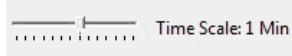

- 500ms
  - 1 Second
  - 5 Seconds
  - 10 Seconds
  - 20 Seconds
  - 30 Seconds
  - 45 Seconds
  - 1 Minute (default)
  - 2 Minutes
  - 5 Minutes
  - 7 Minutes
  - 10 Minutes
  - 30 Minutes
  - 1 Hour
- The Time Scale value is set by the following methods:
    - Clicking on the Time Scale icon at the desired interval location
    - Clicking on the Time Scale icon at the desired location then use the arrow keys or the mouse scroll wheel to decrease or increase the value
    - Clicking and holding the slider and dragging left to decrease and right to increase the value

## Check *DirectSOFT6* File Revision

*DirectSOFT6* has a quick and easy method of looking at the various versions of the files which comprise the software. This feature may never be used, however, this may be useful in the future as additional features are added in upgrade packages, new products, etc.

Open the **Version Browser** by double-clicking on **Version** located under **Utilities** on the DSLaunch menu tree.

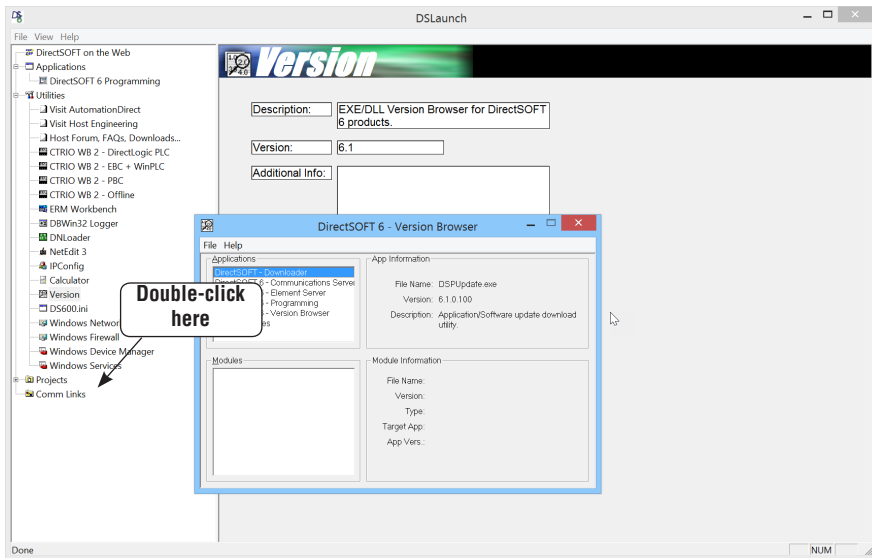

**TIP:** A simple way to check the *DirectSOFT6* version is to open a project program and select **Help > About**.

# **PROTOCOLS AND CABLE DIAGRAMS**

---



## **In This Appendix...**

Protocols and Cables .....	A-2
Programming Cable Diagrams.....	A-6

## Protocols and Cables

*Direct*LOGIC CPUs provide many communication port possibilities. It is helpful to know which programming cable and protocol to use.

<b><i>Direct</i>LOGIC PLC Programming Cable and Wiring Standard Reference</b>					
<b>CPU</b>	<b>Port</b>	<b>Cable</b>	<b>Standard</b>	<b>Jack Style</b>	
DL05	Port 1	D2-DSCBL	RS-232	RJ12 6P6C	
	Port 2	D2-DSCBL	RS-232	RJ12 6P6C	
	D0-DCM	D2-DSCBL-1	D2-DSCBL	RS-232	RJ12 6P6C
			RS-232	HD15	
			RS-422		
		RS-485			
	H0-ECOM(100)		10/100 BASET	RJ45 CAT 5E	
DL06	Port 1	D2-DSCBL	RS-232	RJ12 6P6C	
	Port 2	D2-DSCBL-1	RS-232	HD15	
			RS-422		
			RS-485		
	D0-DCM	D2-DSCBL-1	D2-DSCBL	RS-232	RJ12 6P6C
			RS-232	HD15	
			RS-422		
		RS-485			
	H0-ECOM(100)		10/100 BASET	RJ45 CAT 5E	
D2-230	Port 1	D2-DSCBL	RS-232	RJ12 6P6C	
	D2-DCM	D3-DSCBL-2	RS-232	DB-25	
			RS-422		
D2-240	Port 1	D2-DSCBL	RS-232	RJ12 6P6C	
	Port 2	D2-DSCBL	RS-232	RJ12 6P6C	
	D2-DCM	D3-DSCBL-2	RS-232	DB-25	
			RS-422		
			H2-ECOM(100)	10/100 BASET	RJ45 CAT 5E
D2-250(-1) D2-260 D2-262	Port 1	D2-DSCBL	RS-232	RJ12 6P6C	
	Port 2	D2-DSCBL-1	RS-232	HD15	
			RS-422		
			RS-485		
	D2-DCM	D3-DSCBL-2	RS-232	DB-25	
			RS-422		
		H2-ECOM(100)	10/100 BASET	RJ45 CAT 5E	
D3-330	D3-232-DCU	D3-DSCBL-2	RS-232	DB-25	
D3-340	Port 1	D3-DSCBL-1	RS-232	RJ14 4P4C	
	Port 2	D3-DSCBL-1	RS-232	RJ14 4P4C	
D3-350	Port 1	D2-DSCBL	RS-232	RJ12 6P6C	
	Port 2	D3-DSCBL-2	RS-232	DB-25	
			RS-422		
			RS-485		
	D3-DCM	D3-DSCBL-2	RS-232		
			RS-422		

<b>DirectLOGIC PLC Programming Cable and Wiring Standard Reference</b>				
<b>CPU</b>	<b>Port</b>	<b>Cable</b>	<b>Standard</b>	<b>Jack Style</b>
D4-430 D4-440	Port 0	D4-DSCBL	RS-232	DB-15
	Port 1	D3-DSCBL-2	RS-232	DB-25
	D4-DCM	D3-DSCBL-2	RS-232	
			RS-422	
H4-ECOM(100)		10/100 BASET	RJ45 CAT 5E	
D4-450 D4-454	Port 0	D4-DSCBL	RS-232	DB-15
	Port 1	D3-DSCBL-2	RS-232	DB-25
	Port 2	D2-DSCBL	RS-232	RJ11 6P6C
	Port 3		RS-422	DB-25
	D4-DCM	D3-DSCBL-2	RS-232	
			RS-422	
H4-ECOM(100)		10/100 BASET	RJ45 CAT 5E	

**Notes:**

- To convert an RS-232 cable to USB, purchase part number USB-RS232.
- To connect to RS-485 with USB, purchase part number USB-485M.
- EA-MG-PGM-CBL is a USB alternative for the D2-DSCBL.
- Do not use EA-MG-PGM-CBL with SureStep stepper drives.
- For RS-232/RS-422 use cable part number L19772-100.
- For RS-485 use cable part number L19827-100.
- For Ethernet, Category 5E cable is recommended as a minimum.



## Protocols and Cables (cont'd)

<i>DirectLOGIC PLC Protocols Supported</i>						
CPU	Port	<i>DirectNET</i>	K-Sequence	MODBUS RTU	ECOM	MODBUS TCP
DL05	Port 1	•	•	•		
	Port 2	•	•	•		
	D0-DCM	•	•	•		
		•	•	•		
		•	•	•		
H0-ECOM(100)				•	H0-ECOM100	
DL06	Port 1	•	•	•		
	Port 2	•	•	•		
		•	•	•		
		•	•	•		
	D0-DCM	•	•	•		
		•	•	•		
•		•	•			
H0-ECOM(100)				•	H0-ECOM100	
D2-230	Port 1	•	•	•		
	D2-DCM	•	•	Slave only		
D2-240	Port 1	•	•	•		
	Port 2	•	•	•		
	D2-DCM	•	•	Slave only		
		•	•	Slave only		
H2-ECOM(100)				•	H2-ECOM100	
D2-250(-1) D2-260 D2-262	Port 1	•	•	•		
	Port 2	•	•	•		
		•	•	•		
		•	•	•		
	D2-DCM	•	•	Slave only		
H2-ECOM(100)	•			•	H2-ECOM100	
D3-330	D3-232-DCU	•				
D3-340	Port 1	•				
	Port 2	•		•		
D3-350	Port 1	•	•	•		
		•	•	•		
		•	•	•		
	Port 2	•	•	•		
		•	•	•		
D3-DCM	•	•	Slave only			
		•	•			

## Protocols and Cables (cont'd)

<i>Direct</i> LOGIC PLC Protocols Supported						
CPU	Port	<i>Direct</i> NET	K-Sequence	MODBUS RTU	ECOM	MODBUS TCP
D4-430 D4-440	Port 0	•	•	•		
	Port 1	•	•	•		
	D4-DCM	•	•	Slave only		
		•	•			
H4-ECOM(100)				•	H4-ECOM100	
D4-450 D4-454	Port 0	•	•	•		
	Port 1	•	•	•		
	Port 2	•	•	•		
	Port 3	•	•	•		
	D4-DCM	•	•	Slave only		
		•	•			
H4-ECOM(100)				•	H4-ECOM100	

# Programming Cable Diagrams

Pin labeling conforms to IBM DTE and DCE standards

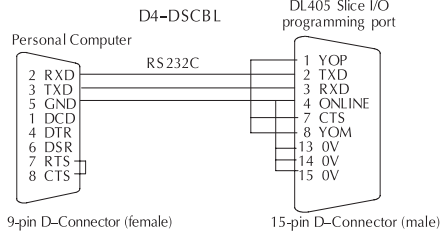
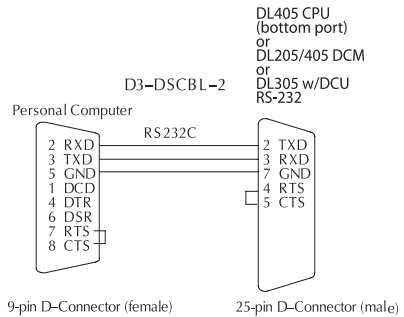
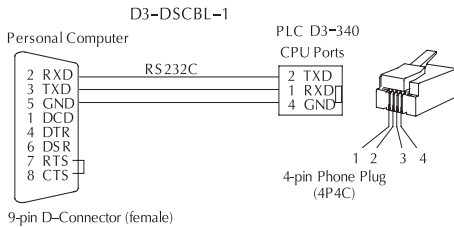
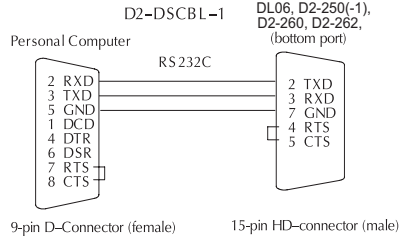
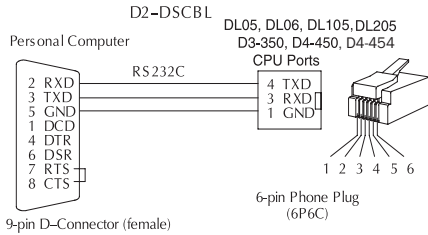

Straight-through Patch Cable

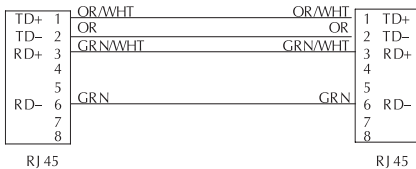

Crossover Patch Cable

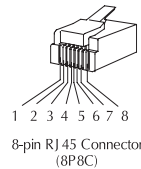
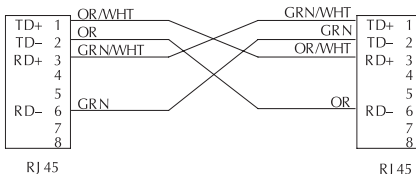

All Ethernet and ECOM patch cables should be Category 5, UTP Cable. The diagram illustrates the appropriate wire position in the RJ45 connector.

# COMMUNICATIONS TROUBLESHOOTING

---



## In This Appendix...

Communications Resources.....	B-2
Editing the DSxxx.ini file.....	B-10
Other Possible Issues .....	B-15

### Communications Resources

If you are using an ECOM and have Windows XP on your PC with a firewall (particularly with SP2), then you must do one of the following:

1. Turn the firewall OFF
2. Create an exception for CSMAIN.EXE application (located in the BIN folder under your *DirectSOFT* folder)
3. Create an exception for port #0x7070 (28784) for both TCP and UDP protocols, which is the port number that all of our Ethernet devices use for communication.

You can control which communications resources on your PC you want to let *DirectSOFT* use by altering the *DirectSOFT* initialization file (DS600.INI):

#### Startup

Using the resources enabled in the .INI file, *DirectSOFT*'s CommServer tries to find PLCs on startup. If it finds any, it creates *DirectSOFT* links to them. If it finds none, it opens without creating links. While using the communication resources on your PC during startup, one of the following events/messages will occur:

***DirectSOFT* comes up normally.**

**“Error connecting to PLC!” or “No response from PLC!”**

This means *DirectSOFT* found the resource on your PC OK, but it had trouble connecting to the PLC.

Check cabling or other physical devices outside of the PC.

If you are using a DL105, they tend to be a bit more sensitive to marginal cables and electrical noise. Try a new cable, especially if you can use the same setup successfully when talking to other *DirectLOGIC* PLCs (e.g. DL205).

On a DL305 system make sure the power supply is capable of supplying enough power for the DCU. If the PLC base is old, then you may need to replace it in order to get communications to work or try external power for the DCM.

Microsoft ActiveSync could be using the COM port.

**Error: cannot access comm port. The port may not be present or another app may be using it”**

This means *DirectSOFT* can't gain access to the COM port because something else is using it.

Check to see if anything else is using COM port, (Start --> Control Panel --> Administrative Tools --> Services) for example:

- i) RSLogix
- ii) PDA Software (Palm Pilot, Pocket PC, etc.)
- iii) GPS Software
- iv) Digital Camera Software
- v) IR (infrared) Drivers
- vi) Microsoft ActiveSync
- vii) Palm OS HotSync
- viii) Harmony Services

Sometimes if upgrading operating systems (e.g. Windows 2K to Windows XP) the COM ports can become dysfunctional. You may have to disable all COM ports in the BIOS and then reinstall the upgrade and re-enable the ports in the BIOS.

If using a USB-to-Serial converter or a USB Port Replicator, its driver may not act like a regular COM port. (*DirectSOFT* “thinks” it is talking to a regular COM port). If this is the case there is no immediate fix. Host Engineering periodically updates *DirectSOFT* attempting to compensate for these kinds of driver problems.

If using a USB-to-Serial converter, sometimes it is very important that you load the driver first, before connecting the device itself. In fact, in some cases if this is done in the wrong order it will take special steps to fix the problem. See the website of the manufacturer of your converter for details.

Try disabling all resources in the .INI file.

### “Transport protocol error”

This means you are using Ethernet as a link and it timed out. This is commonly due to one or more of the following issues:

- Bad cabling; check all cables to make sure they are OK (e.g. Are they susceptible to noise due to bad shielding, etc?).
- Using wrong cable (crossover instead of straight-through or vice versa). Make sure that the Link light is ON; this means that the cable electrical connection is good.
- The cable is running through a very electrically noisy environment.
- ECOM not seated properly. It should be flush with other cards or filler caps.
- If your PC has two or more NICs (Network Interface Cards), try one of these options:

Use the **Pic a Nic** feature to select the network card that the PLC is connected to.

Re-prioritize your NICs by going to Advanced Settings. This is different depending on which Windows OS you have:

If you have Windows XP:

- (1) Start -->Control Panel.
- (2) Double-click on the “Network Connections” icon.
- (3) On the menu at the top, select Advanced --> Advanced Settings...

If you have Windows Vista:

- (1) Start --> Control Panel.
- (2) Double-click on the “Network & Sharing Center” icon.
- (3) At the left of this window, click on “Manage network connections.”
- (4) Press the <ALT> key to make a menu appear at the top of this window.
- (5) On the menu at the top, select Advanced --> Advanced Settings...

If you have Windows 7/8/10:

- (1) Start -->Control Panel (Windows 8; in Desktop View move the cursor to the right hand side of the screen then at the bottom select Control Panel.).
- (2) Select “Network and Intranet” at the top.
- (3) Double-click on the “Network & Sharing Center” icon.
- (4) Press the <ALT> key to make a menu appear at the top of this window.
- (5) On the menu at the top, select Advanced --> Advanced Settings...

Once you have the Advanced Settings pulled up, then it is the same for all Windows OS:

- (1) On the “Adapters and Bindings” tab, in the top window, select the connection you are using.
- (2) Use the green arrows at the right to move this connection to the top of the list.
- (3) Press <OK> and close Network Connections window.
- (4) You may have to reboot your PC.

Uninstall or disable one NIC.

Make sure that the NICs don't have common protocols enabled (i.e. IPX and TCP/IP). In other words, you might enable IPX on one NIC and TCP/IP on the other NIC, but not on both simultaneously.

There are multiple LAN connections in your Network Connections. Disable all but the one you are planning on using.

There are “Bridged” LAN connections in your Network Connections. Unbridge them by setting them simply to “Disabled.”

There are WAN connections enabled. Disable them.

Using an H0-ECOM/ECOM100 and the PLC firmware is not up to date. Make sure it is.

Using an H0-ECOM/ECOM100 and a D0-06LCD display but it is not up to date. Make sure the LCD has a date code of 032A or later.

Using an H2-ECOM/ECOM100 and you have it installed in Slot 0 (the slot adjacent to the CPU). Install it in a different slot.

Using an H4-ECOM/ECOM100 and it has bent or retracted pins on the ECOM and/or the CPU. Check for bent/retracted pins.

The ECOM, CPU or the backplane is bad.

Extremely busy network traffic. Isolate the network.

Busy network or PLC sluggishness. Under the Link’s Advanced Settings (Link Editor, Port Tab), try increasing the Timeout and Retry values (e.g. Try going to a DOS command prompt window and using the “ping” command to ping the ECOM’s IP address. If Ping works, note the response times. In the link’s Advanced Settings (Link Editor, Port Tab), increase the Timeout value to at least 2 or 3 times the response value).

### **“PLC is not in terminal mode!...”**

The mode switch on the PLC is in the RUN or STOP position. Switch it to the TERM position.

### **“Unable to open Online Program”**

The mode switch on the PLC is in the RUN or STOP position. Switch it to the TERM position.

### **“CSMAIN.EXE error” or *DirectSOFT* locks up or mouse hangs up.**

This means that *DirectSOFT*’s CommServer has accessed a resource on your PC that has a conflict or doesn’t exist.

First try upgrading to at least *DirectSOFT* v4.0 Build 22. We believe we have fixed the last of these types of failures in this build (If you have v3.0 there are some improvements in Build 80, however, it could still have some problems since we have stopped development on v3.0).

If you have DSDData simultaneously using the same link as *DirectSOFT* then instead, make separate links (i.e. one link for DSDData and one link for *DirectSOFT*).



Try disabling all resources in the .INI file.

Make sure TCP/IP protocol is loaded.

If using v4.0 Build 16 or earlier, or v3.0 Build 71 or earlier, you may need to:

- (1) Upgrade to later version;
- (2) Make sure IPX protocol is loaded (see DirectSOFT FAQ0183 for installing protocols) for the NIC you are using.

Microsoft ActiveSync could be using the COM port.

### **“Error opening connection to Ethernet device”**

This is usually caused by having two or more NIC (Network Interface Cards), try one of these options:

Reprioritize your NICs by going to Advanced Settings. This is different depending on which Windows OS you have:

If you have Windows XP:

- (1) Start -->Control Panel.
- (2) Double-click on the “Network Connections” icon.
- (3) On the menu at the top, select Advanced --> Advanced Settings...

If you have Windows Vista:

- (1) Start --> Control Panel.
- (2) Double-click on the “Network & Sharing Center” icon.
- (3) At the left of this window, click on “Manage network connections.”
- (4) Press the <ALT> key to make a menu appear at the top of this window.
- (5) On the menu at the top, select Advanced --> Advanced Settings...

If you have Windows 7/8/10:

- (1) Start -->Control Panel (Windows 8; in Desktop View move the cursor to the right hand side of the screen then at the bottom select Control Panel.).
- (2) Select “Network and Intranet” at the top.
- (3) Double-click on the “Network & Sharing Center” icon.
- (4) Press the <ALT> key to make a menu appear at the top of this window.
- (5) On the menu at the top, select Advanced --> Advanced Settings...

Once you have the Advanced Settings pulled up, then it is the same for all Windows OSs:

- (1) On the “Adapters and Bindings” tab, in the top window, select the connection you are using.
- (2) Use the green arrows at the right to move this connection to the top of the list.
- (3) Press <OK> and close Network Connections window.
- (4) You may have to reboot your PC.

Uninstall or disable one NIC.

Make sure that the NICs don’t have common protocols enabled (i.e. IPX and TCP/IP). In other words, you might enable IPX on one NIC and TCP/IP on the other NIC, but not on both simultaneously.

### “Comm error reading program from PLC”

The mode switch on the PLC is in the RUN or STOP position. Switch it to the TERM position.

This error means that *DirectSOFT* received an incorrect response from the PLC, so the physical connection is probably OK; however, it is possible that the port of the PLC itself is defective.

If you are using a USB-to-Serial converter it could be there is an incompatibility between your PC and the converter. (e.g., we know of an incompatibility between the Belkin F5U409-CU converter and the Toshiba 5005 laptop).

Make sure you are not running two copies of *DirectSOFT* simultaneously (like v3.0 and v4.0). Also, along these lines, if you do install two versions, this is OK as long as they are in different folders and are not run at the same time.

We have found that RSLogix (Allen-Bradley) software interferes with the PC's communications over serial ports (e.g. COM1). So if doing a serial link and you get this error, it could be due to this software. Make sure that this software is not running in the background, or that it does not run in the Terminate Stay Ready (TSR) fashion.

Increase the link's Retries and Timeout values; especially if using a modem link.

If using a modem link, make sure that both the Compression and Error Correction are turned OFF.

### **“Knowledge base mismatch”**

Message means the CPU picked for the link is not supported in the installed version of *DirectSOFT*.

### **“Error attempting to access unlocked device”**

This is caused when trying to reconnect to a PLC after *DirectSOFT* disconnected from it improperly. Solution is normally to either try again, or power cycle the PLC.

To prevent this from happening in the future, either:

Use the PLC -->Disconnect from *DirectSOFT* before unplugging the cable to the PLC.

Close *DirectSOFT* before unplugging the cable to the PLC

### **Goes offline by itself after using the link.**

We have found the only remedy for this strange behavior is to uninstall *DirectSOFT* and then reinstall it.

### **Get a PLC password prompt; but the PLC doesn't have a password.**

This is caused by data errors in the communication. The problem is electrical noise either due to an excessively noisy environment, or a bad cable (e.g. shielding going bad).

### **“Comm error unlocking PLC”**

The first thing *DirectSOFT* tries to do when connecting is to unlock the PLC. This is to see if the PLC sends back a warning that there is a password. If you get this message instead of a password prompt, it means that something went amiss when *DirectSOFT* attempted to unlock. The PLC sent back an invalid response or didn't send a reply at all. For solutions try the things listed under “Transport protocol error” above.

### **“Support for the PLC type specified in the link is not installed”**

This is usually caused by one of the following:

Unknown PLC specified in the link, therefore check if the CPU specified in the link matches your hardware.

PLC is not supported with the version of *DirectSOFT* you are using.

*DirectSOFT* cannot find the knowledge base DLL. This is usually an installation problem. You may need to uninstall and reinstall *DirectSOFT* making sure you are the Administrator of your PC.

PLC responding to link is sending an invalid identifier. This may be a PLC problem. You might try power cycling the PLC.

### “Error reading PLC ID”

This means the link can talk to the PLC port, but it cannot actually get the PLC ID (i.e. it’s connected properly but the specific transaction to read the PLC ID fails).

H4-ECOM/ECOM100s or DCMs have bent pins on either the module itself or on the PLC’s backplane for that slot.

Communication is attempted using DirectNET (or ECOM) protocol instead of K-sequence (this will be repaired in *DirectSOFT* v6.0)

### “Operation not supported”

This means *DirectSOFT* gave a command that the PLC did not recognize, or the checksum of the transmission was incorrect. Possible solutions are as follows:

Check physical connection (COM port, cable, USB-to-serial driver, etc.)

Slow baud rate down. If this works, this is an indication of possible noise interference.

Attempt to clear scratchpad memory in the PLC and power cycle.

A means of troubleshooting would be to use the Dump = 1 feature. See the following, under DUMP heading.

## USB-TO-SERIAL Devices

These devices have drivers with them that should make them act like regular COM ports. However there have been a few vendors that don’t do this with their drivers. *DirectSOFT* “thinks” it is talking to a COM port, Ethernet NIC or modem.

The order of installation, however, seems to be important:

1. Install USB device driver first.
2. Connect the USB device secondly.

### DUMP (used to troubleshoot SERIAL and MODEM links)

When you can't figure out why things won't work right, you can use this debug function with a little help from Automation Direct, or Host Engineering. This parameter is in the .INI file.

-To edit the DUMP parameter in the .INI file, see the section on editing DSxxx.ini.

After making the needed .INI file change you should start the debug window logger:

1. Start --> Programs --> AutomationDirect Tools --> DBWin32 Logger
2. Start *DirectSOFT*. *DirectSOFT* will ask you if you want to enable the debug mode. Answer <YES>.
3. Now *DirectSOFT* will dump information into the open debug window. Save this data into a text file and send to Automation Direct or Host Engineering.

## Editing the DSxxx.ini file

PICK THE GROUP OF INSTRUCTIONS BELOW THAT BEST APPLIES TO YOUR PC.

If you have Windows Vista, skip to the heading Windows Vista below. If not, read the information under the heading "Windows XP and Windows 7/8."

### Windows XP and Windows 7/8/10

If you have *DirectSOFT* v3, then the .INI file must be searched for and manually edited. The easiest way to do this is:

- (1) Close *DirectSOFT* and DSLaunch.
- (2) Use the Windows Start button: Start -->Run...
- (3) Type in ds300.ini and press OK. This will open the file in NotePad text editor.
- (4) Make the edits; save the file and exit.
- (5) Restart DSLaunch (or *DirectSOFT*).

If you have *DirectSOFT* v4, v5 or v6, then the easiest way to edit this file is:

- (1) Close *DirectSOFT*.
- (2) Start DSLaunch.
- (3) In the left column under Utilities, double-click DS400.ini (or DS500.ini, or DS600.ini). This will open the file in NotePad text editor.

- (4) Make the edits; save the file and exit.
- (5) Restart DSLaunch (or *DirectSOFT*).

Another option to try if the steps above do not work:

- (1) Close *DirectSOFT*.
- (2) Click Start button.
- (3) In the Search programs and files box, type in DS400.ini (or DS500.ini, or DS600.ini).
- (4) Click on the search result and edit that file; save the file and exit.
- (5) Restart DSLaunch (or *DirectSOFT*).

### Windows Vista

Windows Vista has some extra protection features, so the above procedures may not work depending on its settings. Windows Vista has a feature called UAC (User Access Control) that is, by default, turned on. However, it is possible to turn this feature off, and this dramatically affects the editing of the .INI file.

To modify the UAC setting:

1. Use the Windows Start button: Start -->Control Panel.
2. Click on User Accounts.
3. Click on Turn UAC ON/OFF. This will tell you if this feature is ON or OFF. Depending on this setting go to the proper section below (UAC=ON or UAC=OFF).

### UAC = ON

With UAC=ON, the security measures of Windows Vista create a virtual store copy of your .INI file and redirect *DirectSOFT* to use this copy instead of the one that is normally stored in the C:\Windows folder.

If you have *DirectSOFT* v3, v4, v5.0 or v5.1 then you will have to find this file manually and edit it:

- (1) Close *DirectSOFT* and DSLaunch.
- (2) Use Windows Explorer to browse to: c:\Users\\AppData\Local\VirtualStore\Windows\  
VirtualStore\Windows\
- (3) Find the DS300 (or DS400, or DS500, or DS600.INI) file and open it with NotePad.

(4) Make your edits; save the file and exit.

(5) Restart DSLaunch (or *DirectSOFT*).

If you have *DirectSOFT* v5.2, v5.3 or v6:

(1) Close *DirectSOFT*.

(2) Start DSLaunch.

(3) In the left column under Utilities, double-click DS500.ini (or DS600.ini). This will open the correct file in NotePad text editor.

(4) Make your edits; save the file and exit.

(5) Restart DSLaunch (or *DirectSOFT*).

### UAC = OFF

Regardless of the version of *DirectSOFT*, this procedure has to be used:

1. Close DirectSOFT and DSLaunch.
2. Use the Windows Start button: Start -->Run...
3. Type in ds300.ini (or ds400.ini, or ds500.ini, or ds600.ini) and press OK. This will open the file in NotePad text editor.
4. Make your edits; save the file and exit.
5. Restart DSLaunch (or *DirectSOFT*).

### Other Editable Parameters

The following parameters can be added (or adjusted) in the DS600.INI (DS300.INI / DS400.INI / DS500.INI) file.

COMxEnable: Enable, disable, add or delete serial COM port resources for links.

ModemEnable: Enable or disable serial modem resource.

EthernetEnable: Enable or disable Ethernet resources for links.

Autosense: Enable or disable the autosensing of links on startup. (Once links have been created, they are validated each time you start DSLaunch).

Dump: Causes link to output serial connection debug information to a file for troubleshooting links. This feature is used in conjunction with DBWin32 logger.

**PROGRAM COLORS:** Modify default program colors. The parameter numbers and colors are not defined in a user-friendly manner. Therefore this should only be used to fix a problem.

**UDPPortNumEnable:** Enable or disable UDP port numbering parameter for links.

**PROJECT PATH:** Modify default project path.

**LadderPalette:** Enable or disable ladder logic palette.

**UseLargeBtns:** Modify toolbar button size.

**BACKUP PATH:** Modify default backup project path.

**RTSxDelay:** Modify serial RTS timing control.

**OnTheWeb:** Enable, disable the DSLaunch's "DirectSOFT on the Web" feature.

**INFLOOPTIMEOUT:** Set DirectSOFT's internal loop timeout value as a protection against infinite loops that can cause crashes. This number is the maximum number of loops allowed to do an internal operation in DirectSOFT. Under normal conditions, this number will never be reached. But in cases where there could be very large databases, this number may need to be increased to allow DirectSOFT more loops to complete a certain operation.



## Appendix B: Communications Troubleshooting

Parameter Name	Heading in File	Syntax	Notes	Example
<i>COMxEnable</i>	[devasync.dll]	COMxEnable=y	x = COM port number y = 0 (to disable) 1 (to enable)	COM5Enable=1
<i>ModemEnable</i>	[devasync.dll]	ModemEnable=x	x = 0 (to disable) 1 (to enable)	ModemEnable=1
<i>EthernetEnable</i>	[devether.dll]	EthernetEnable=x	x = 0 (to disable) 1 (to enable)	EthernetEnable=1
<i>Autosense</i>	[Comm Server]	Autosense=x		Autosense=0
<i>Dump</i>	[devasync.dll]	Dump=x	x = 0 (to disable) 1 (to enable)	Dump=1
<i>PROGRAM COLORS<sup>1</sup></i>	[PROGRAM COLORS]	x=y	x = parameter number y = color number	9=16711680
<i>UDPPortNum Enable<sup>2</sup></i>	[devether.dll]	UDPPortNum Enable=x	x = 0 (to disable) 1 (to enable)	UDPPortNumEnable=1
<i>PROJECT PATH</i>	[PATHS]	PROJECT PATH=x	x = <folder path>	PROJECT PATH=c:\MyProjects
<i>LadderPalette<sup>3</sup></i>	[SETUP]	LadderPalette=x	x = 0 (to turn off) 1 (to turn on)	LadderPalette=1
<i>UseLargeBtns<sup>4</sup></i>	[SETUP]	UseLargeBtns=x	x = 0 (use small buttons) 1 (use large buttons)	UseLargeBtns=1
<i>BACKUP PATH</i>	[PATHS]	BACKUP PATH=x	x = <folder path>	BACKUP PATH=c:\MyBackups
<i>RTSxDelay</i>	[devasync.dll]	RTSxDelay=y	x = On (for on-delay) Off (for off-delay) y = <milliseconds>	RTSOnDelay=5
<i>OnTheWeb</i>	[DSLlaunch]	OnTheWeb=x	x = 0 (to disable) x = 1 (to enable)	OnTheWeb=1
<i>INFLOOPTIME OUT<sup>5</sup></i>	[SETUP]	INFLOOPTIME OUT=x	x = 1 to 4294967296	INFLOOPTIMEOUT=65536

### Notes:

1. Only use this to fix a problem. The parameter and color numbers are not defined in a user-friendly manner.
2. Became available with **DirectSOFT** v3.0c Build 54 (01-Sep-2000).
3. Became available with **DirectSOFT** v4.0 Build 18 (09-Dec-2002).
4. Only available in **DirectSOFT** v4.0. Not available in **DirectSOFT** v5.0.
5. Only modify this if you have received the “Infinite Loop Timeout” message. This parameter became available with **DirectSOFT** v4.0 Build 20 (27-Jun-2003).

## Other Possible Issues

### How to Change USB-Serial Port Assignment

1. Close DSLaunch and *DirectSOFT*.
2. Use Windows Start button: Start > Control Panel > System > Hardware > Device Manager (WinXP or earlier). Or Start > Control Panel > Device Manager (WinVista/Win7). Depending on your version and setup of Windows, these paths might be more or less direct than listed. You can also type in Device Manager in the Windows Help and get specific directions.
3. Go to Ports, expand the section and locate your USB converter. It must be here, with no yellow warnings, and must have a COM port assigned (e.g. COM5 or similar).
4. Right-click on the adapter, select Properties.
5. Select the Port Settings tab.
6. Click the <Advanced> button.
7. There will be a field in the lower left that shows the COM port assignment. Click the right edge of that field, and all the COM ports will show up.
8. Select COM1 or COM2 (as long as they do not show “In Use”)
9. Click <OK> on all the windows that opened up. Your USB adapter should now show the COM port you have selected.
10. Close Device Manager and Control Panel.
11. Start DSLaunch/*DirectSOFT*. They might auto-detect your PLC and create a link for you. If not, then follow the normal procedure to create a link and select whichever COM port you selected for your adapter.

### “PORT UNAVAILABLE OR IN USE”

This message is typically caused by the Allen-Bradley software RSLinx controlling the COM ports. You must turn it off with Task Manager. Allen-Bradley Harmony can also cause this. Siemens software can cause this as well. In much rarer instances, docking stations or IR transfer adapters can also cause problems.

### Laptop AC Adapter Issue

If you are having problems connecting to a PLC with a laptop, and you are using a serial connection or USB-to-Serial converter, try closing DSLaunch/*DirectSOFT*, removing the AC adapter so you are running just from battery. Then re-open *DirectSOFT* and try to connect again.



**NOTE:** Exhaustive FAQ's for *DirectSOFT* as well as other HOST Engineering products can be found at: <http://hosteng.com/>

# **HARDWARE – SOFTWARE COMPATIBILITY TABLE**

---



## **In This Appendix...**

Hardware – Software Compatibility Table.....	C-2
--	-----

## Hardware – Software Compatibility Table

*Direct*LOGIC CPUs require software versions to be compatible to enable proper function and programming capability. Please refer to the table below to ensure compatibility.

<i>Direct</i> LOGIC CPUs	<i>Direct</i> SOFT Version																	
	v1.12i	v2.0	v2.1	v2.2	v2.3	v2.3a	v2.4	v2.4a	v3.0	v4.0	v5.0	v5.1	v5.2	v5.3	v6.0	v6.1	v6.2	v6.3
DL05							Y	Y	Y	Y	Y	Y	Y	Y	Y	Y	Y	Y
DL06										Y	Y	Y	Y	Y	Y	Y	Y	Y
DL130		Y	Y	Y	Y	Y	Y	Y	Y	Y	Y	Y	Y	Y	Y	Y	Y	Y
D2-230	Y	Y	Y	Y	Y	Y	Y	Y	Y	Y	Y	Y	Y	Y	Y	Y	Y	Y
D2-240	Y	Y	Y	Y	Y	Y	Y	Y	Y	Y	Y	Y	Y	Y	Y	Y	Y	Y
D2-250			Y	Y	Y	Y	Y	Y	Y	Y	Y	Y	Y	Y	Y	Y	Y	Y
D2-250-1			(1)	(1)	(1)	(1)	(1)	(1)	(1)	Y	Y	Y	Y	Y	Y	Y	Y	Y
D2-260										Y	Y	Y	Y	Y	Y	Y	Y	Y
D2-262																		Y
TI-325	Y	Y	Y	Y	Y	Y	Y	Y	Y	Y	Y	Y	Y	Y	Y	Y	Y	Y
D3-330	Y	Y	Y	Y	Y	Y	Y	Y	Y	Y	Y	Y	Y	Y	Y	Y	Y	Y
D3-330P	Y	Y	Y	Y	Y	Y	Y	Y	Y	Y	Y	Y	Y	Y	Y	Y	Y	Y
TI-330S	Y	Y	Y	Y	Y	Y	Y	Y	Y	Y	Y	Y	Y	Y	Y	Y	Y	Y
TI-335	Y	Y	Y	Y	Y	Y	Y	Y	Y	Y	Y	Y	Y	Y	Y	Y	Y	Y
D3-340	Y	Y	Y	Y	Y	Y	Y	Y	Y	Y	Y	Y	Y	Y	Y	Y	Y	Y
D3-350				Y	Y	Y	Y	Y	Y	Y	Y	Y	Y	Y	Y	Y	Y	Y
TI-425	Y	Y	Y	Y	Y	Y	Y	Y	Y	Y	Y	Y	Y	Y	Y	Y	Y	Y
D4-430	Y	Y	Y	Y	Y	Y	Y	Y	Y	Y	Y	Y	Y	Y	Y	Y	Y	Y
TI-435	Y	Y	Y	Y	Y	Y	Y	Y	Y	Y	Y	Y	Y	Y	Y	Y	Y	Y
D4-440	Y	Y	Y	Y	Y	Y	Y	Y	Y	Y	Y	Y	Y	Y	Y	Y	Y	Y
D4-450		Y	Y	Y	Y	Y	Y	Y	Y	Y	Y	Y	Y	Y	Y	Y	Y	Y
D4-454																Y	Y	Y

(1) Partially compatible. The restriction is that the D2-250-1 local expansion I/O cannot be seen in *Direct*SOFT