



D0-DEVNETS

DeviceNet Slave Module

User Manual

Manual Number D0-DEVNETS-M



WARNING

Thank you for purchasing automation equipment from **Automationdirect.com**[™]. We want your new **DirectLOGIC**[™] automation equipment to operate safely. Anyone who installs or uses this equipment should read this publication (and any other relevant publications) before installing or operating the equipment.

To minimize the risk of potential safety problems, you should follow all applicable local and national codes that regulate the installation and operation of your equipment. These codes vary from area to area and usually change with time. It is your responsibility to determine which codes should be followed, and to verify that the equipment, installation, and operation are in compliance with the latest revision of these codes.

At a minimum, you should follow all applicable sections of the National Fire Code, National Electrical Code, and the codes of the National Electrical Manufacturer's Association (NEMA). There may be local regulatory or government offices that can also help determine which codes and standards are necessary for safe installation and operation.

Equipment damage or serious injury to personnel can result from the failure to follow all applicable codes and standards. We do not guarantee the products described in this publication are suitable for your particular application, nor do we assume any responsibility for your product design, installation, or operation.

*Our products are not fault-tolerant and are not designed, manufactured or intended for use or resale as on-line control equipment in hazardous environments requiring fail-safe performance, such as in the operation of nuclear facilities, aircraft navigation or communication systems, air traffic control, direct life support machines, or weapons systems, in which the failure of the product could lead directly to death, personal injury, or severe physical or environmental damage ("High Risk Activities"). **Automationdirect.com**[™] specifically disclaims any expressed or implied warranty of fitness for High Risk Activities.*

For additional warranty and safety information, see the Terms and Conditions section of our Desk Reference. If you have any questions concerning the installation or operation of this equipment, or if you need additional information, please call us at 770-844-4200.

This publication is based on information that was available at the time it was printed. At **Automationdirect.com**[™] we constantly strive to improve our products and services, so we reserve the right to make changes to the products and/or publications at any time without notice and without any obligation. This publication may also discuss features that may not be available in certain revisions of the product.



Trademarks

This publication may contain references to products produced and/or offered by other companies. The product and company names may be trademarked and are the sole property of their respective owners. **Automationdirect.com**[™] disclaims any proprietary interest in the marks and names of others.

Copyright 2001, Automationdirect.com[™] Incorporated
All Rights Reserved

No part of this manual shall be copied, reproduced, or transmitted in any way without the prior, written consent of **Automationdirect.com**[™] Incorporated. **Automationdirect.com**[™] retains the exclusive rights to all information included in this document.



AVERTISSEMENT



Nous vous remercions d'avoir acheté l'équipement d'automatisation de **Automationdirect.com™**. Nous tenons à ce que votre nouvel équipement d'automatisation **DirectLOGIC™** fonctionne en toute sécurité. Toute personne qui installe ou utilise cet équipement doit lire la présente publication (et toutes les autres publications pertinentes) avant de l'installer ou de l'utiliser.

Afin de réduire au minimum le risque d'éventuels problèmes de sécurité, vous devez respecter tous les codes locaux et nationaux applicables régissant l'installation et le fonctionnement de votre équipement. Ces codes diffèrent d'une région à l'autre et, habituellement, évoluent au fil du temps. Il vous incombe de déterminer les codes à respecter et de vous assurer que l'équipement, l'installation et le fonctionnement sont conformes aux exigences de la version la plus récente de ces codes.

Vous devez, à tout le moins, respecter toutes les sections applicables du Code national de prévention des incendies, du Code national de l'électricité et des codes de la National Electrical Manufacturer's Association (NEMA). Des organismes de réglementation ou des services gouvernementaux locaux peuvent également vous aider à déterminer les codes ainsi que les normes à respecter pour assurer une installation et un fonctionnement sûrs.

L'omission de respecter la totalité des codes et des normes applicables peut entraîner des dommages à l'équipement ou causer de graves blessures au personnel. Nous ne garantissons pas que les produits décrits dans cette publication conviennent à votre application particulière et nous n'assumons aucune responsabilité à l'égard de la conception, de l'installation ou du fonctionnement de votre produit.

Nos produits ne sont pas insensibles aux défaillances et ne sont ni conçus ni fabriqués pour l'utilisation ou la revente en tant qu'équipement de commande en ligne dans des environnements dangereux nécessitant une sécurité absolue, par exemple, l'exploitation d'installations nucléaires, les systèmes de navigation aérienne ou de communication, le contrôle de la circulation aérienne, les équipements de survie ou les systèmes d'armes, pour lesquels la défaillance du produit peut provoquer la mort, des blessures corporelles ou de graves dommages matériels ou environnementaux ("activités à risque élevé"). La société **Automationdirect.com™** nie toute garantie expresse ou implicite d'aptitude à l'emploi en ce qui a trait aux activités à risque élevé.

Pour des renseignements additionnels touchant la garantie et la sécurité, veuillez consulter la section Modalités et conditions de notre documentation. Si vous avez des questions au sujet de l'installation ou du fonctionnement de cet équipement, ou encore si vous avez besoin de renseignements supplémentaires, n'hésitez pas à nous téléphoner au 770-844-4200.

Cette publication s'appuie sur l'information qui était disponible au moment de l'impression. À la société **Automationdirect.com™**, nous nous efforçons constamment d'améliorer nos produits et services. C'est pourquoi nous nous réservons le droit d'apporter des modifications aux produits ou aux publications en tout temps, sans préavis ni quelque obligation que ce soit. La présente publication peut aussi porter sur des caractéristiques susceptibles de ne pas être offertes dans certaines versions révisées du produit.

Marques de commerce

La présente publication peut contenir des références à des produits fabriqués ou offerts par d'autres entreprises. Les désignations des produits et des entreprises peuvent être des marques de commerce et appartiennent exclusivement à leurs propriétaires respectifs. **Automationdirect.com™** nie tout intérêt dans les autres marques et désignations.

Copyright 2001, **Automationdirect.com™** Incorporated

Tous droits réservés

Nulle partie de ce manuel ne doit être copiée, reproduite ou transmise de quelque façon que ce soit sans le consentement préalable écrit de la société **Automationdirect.com™** Incorporated. **Automationdirect.com™** conserve les droits exclusifs à l'égard de tous les renseignements contenus dans le présent document.

Manual Revisions

If you contact us in reference to this manual, be sure to include the revision number.

Title: D0–DEVNETS DeviceNet Slave Module User Manual

Manual Number: D0–DEVNETS–M

Edition	Date	Description of Changes
Original	11/01	Original issue
Rev. A	11/02	Added DL06 references

Table of Contents

Chapter 1: Getting Started

Introduction	1-2
The Purpose of this Manual	1-2
Supplemental Manuals	1-2
Who Should Read this Manual	1-2
Technical Support	1-2
Conventions Used	1-3
Key Topics for Each Chapter	1-3
Introduction to DeviceNet	1-4
DeviceNet Concepts	1-4
The ODVA	1-4
General Information about the D0-DEVNETS	1-5
Specifications	1-5
Mini Glossary	1-5

Chapter 2: Installing the DeviceNet Slave Module

Installing the D0-DEVNETS Slave Module	2-2
Setting the DIP Switch (SW1)	2-2
Remove the Slot Cover	2-4
Insert the Module	2-5
Set the Node Address	2-6
Wiring the Adapter to a DeviceNet Network	2-6
Configure the Adapter	2-7
Configuring the DeviceNet Adapter	2-7
Status Indicators	2-8
D0-DEVNETS Parameter Setup	2-9
D0-DEVNETS Default Parameters	2-9
Software and Firmware Requirements	2-10
How to Update Your DirectSOFT32 Programming Software	2-10
How to Update Your DL05 Firmware	2-11
Changing the D0-DEVNETS Setup Parameters	2-12

Appendix A: Specifications

Appendix B: Tables

Data Input and Output Tables	B-2
Device Profile Tables	B-5

Appendix C: Image Table Mapping

Image Table Mapping	C-2
PLC Mode Image Table Mapping	C-8

Appendix D: Special Relays and DIP Switch Parameter Initializing

Network Status Special Relays	D-2
Initializing Parameter Values	D-2

Appendix E: D0-DEVNETS Think & Do/Entivity Setup

D0-DEVNETS Think & Do/Entivity Setup	E-2
T&D/Entivity setup for PC control	E-2
Setup Think & Do with DL05 on a network	E-4
T & D Studio setup	E-5

Appendix F: OIT with D0-DEVNETS

Using an OIT with D0-DEVNETS	F-2
T&D Studio	F-2

Appendix G: D0-DEVNETS and Allen-Bradley Set up

Setup D0-DEVNETS with Allen-Bradley RSNetWorxt	G-2
RSLinx	G-2
RSLogix	G-6
Configure D0-DEVNETS with RSNetWorx	G-8
Using the EDS file	G-8
Go on line	G-11
Set up I/O parameters	G-12
Map the nodes	G-15
Set Class Instance Attribute	G-18

Getting Started

In This Chapter. . . .

- Introduction
 - Introduction to DeviceNet
 - General Information About D0-DEVNETS
-

Introduction

The Purpose of this Manual

This manual describes the installation and operation of the D0-DEVNETS Slave Module (D0-DEVNETS).

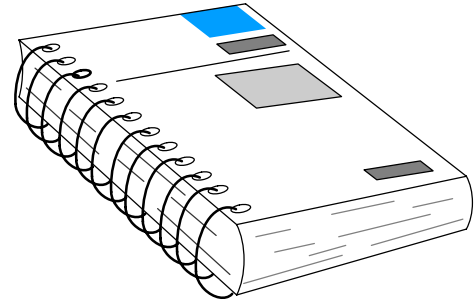

Supplemental Manuals

The following manuals are essential for the proper use of your DL05 DeviceNet Slave Module.

- DL-05 Micro PLC User Manual part number **D0-USER-M**
This manual contains very important information, including a complete I/O Module Memory Map. The Memory Map is crucial in designing and implementing the I/O system.
- The PLC/PC software manual
- The DeviceNet software (if separate) manual
- The DeviceNet Scanner (or Master) manual

Who Should Read this Manual

If you have a working knowledge of the DeviceNet network, the DeviceNet software and PLC or PC which you are using, this manual will help you configure and install your D0-DEVNETS Slave Module.

Technical Support

We strive to make our manuals the best in the industry and rely on your feedback in reaching our goal. If you cannot find the solution to your particular application, or, if for any reason you need additional technical assistance, please call us at

770-844-4200.

Our technical support team is glad to work with you in answering your questions. They are available **weekdays from 9:00 a.m. to 6:00 p.m. Eastern Time**. We also encourage you to visit our website where you can find technical and nontechnical information about our products and our company.

www.automationdirect.com

Conventions Used



The “light bulb” icon in the left-hand margin indicates a **tip** or **shortcut**.



The “note pad” icon in the left-hand margin indicates a **special note**.

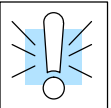

The “exclamation mark” icon in the left-hand margin indicates a **warning** or **caution**. These are very important because the information may help you prevent serious personal injury or equipment damage.

Key Topics for Each Chapter

The beginning of each chapter will list the key topics that can be found in that chapter.

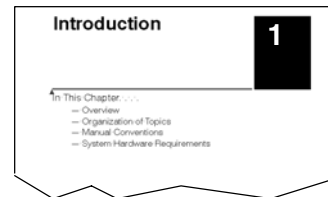

Introduction to DeviceNet

DeviceNet is a low-cost control bus used to connect field devices to PLCs and PCs. DeviceNet is designed to reduce the need for hard-wiring while providing device-level diagnostics. There are a host of manufacturers of DeviceNet products, offering an array of products including sensors, motor drives and starters, PLCs, pushbuttons, remote I/O systems, etc.

DeviceNet Concepts

Here are some DeviceNet concepts you may find helpful.

- DeviceNet supports various communication structures including Peer to Peer, Multi-master and Master/Slave. *The D0-DEVNETS uses the predefined Master/Slave connection.*
- DeviceNet has two types of messaging: Explicit Messaging and I/O Messaging.
 - Explicit Messaging is low priority, not time-critical and usually for configuration/diagnostic purposes.
 - I/O Messaging is time-critical and high priority for I/O data transfer. I/O Messaging comes in four types:
 - Strobed
 - Polled (*The D0-DEVNETS only supports Polled.*)
 - Change of State (or COS)
 - Cyclic
- A single DeviceNet network is limited to 64 nodes. A node can be a single-bit device, such as a limit switch, or a remote I/O slave with several I/O modules, such as the D0-DEVNETS. The Master (Scanner) is usually assigned to node address 0, and many Slave devices have a factory default node address of 63.
- DeviceNet has the following data rates (with maximum bus lengths):
 - 125 kbps (bus length = 500m max.)
 - 250 kbps (bus length = 250m max.)
 - 500 kbps (bus length = 100m max.)
- The 24V DeviceNet power supply must be grounded at only one point. The V- terminal must be connected to Protective Earth Ground at the power supply only.

The ODVA

The DeviceNet standard is maintained by the ODVA (Open DeviceNet Vendor Association, Inc.). Contact the ODVA for detailed information about DeviceNet.

Open DeviceNet Vendor Association, Inc.

20423 State Road 7

Suite 499

Boca Raton, FL 33498

Phone: (954) 340-5412

Fax: (954) 340-5413

Internet: www.odva.org

Email: odva@powerinternet.com

General Information about the D0-DEVNETS

The D0-DEVNETS slave module offers the following features:

- The D0-DEVNETS installs into any of the DL05 PLC's option slot. The PLC must have firmware version 3.0 or higher installed.
- The D0-DEVNETS can be installed in any of the four option slots of the DL06 PLC. The PLC must have firmware version 1.0 or higher installed.
- Only one D0-DEVNETS can be installed in the DL06 PLC.
- The D0-DEVNETS is an interface for DeviceNet (slave mode only).
- The D0-DEVNETS collects and reports all discrete I/O data to a DeviceNet master as polled data.
- The D0-DEVNETS does not poll analog I/O data, the analog I/O is looked at in registers. Refer to the **D0-DEVNETS-M** pointer method setup for the analog module being used.
- The D0-DEVNETS can either be configured in the DL05/06 for slave I/O mode without the need for a ladder program or programmed with ladder control logic as part of a network.
- LEDs for the Module Status and Network Status.
- Node address switches are easily accessed.

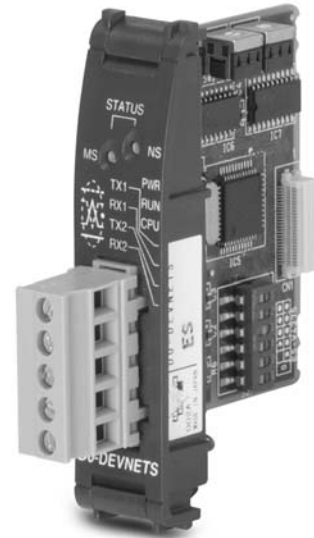

Specifications

Environmental specifications for the D0-DEVNETS are the same as for the DL05/06 PLCs. UL and CE approvals are pending. See Appendix A for detailed specifications.

Mini Glossary

Below is a small glossary of terms used in this manual.

Scanner or Master

The DeviceNet Master of which the D0-DEVNETS is a slave. This can be either a PLC module or a card in your PC.

Adapter or Slave

Short for the D0-DEVNETS Slave Module. The adapter is also referred to as a Network Interface Module elsewhere.

Node Address or MAC ID

The unique device address on a DeviceNet network. There are a maximum of 64 total (0-63). Usually the scanner is node 0.

Installing the DeviceNet Slave Module

In This Chapter. . . .

- Installing the D0–DEVNETS Slave Module
 - Configure the Adapter
 - D0–DEVNETS Parameter Setup
 - Software and Firmware Requirements
 - Writing the D0–DEVNETS Setup
-

Installing the D0-DEVNETS Slave Module

Setting the DIP Switch (SW1)



The DIP switch, SW1 must be set before installing the DeviceNet slave module in the DL05 option slot or in one of the DL06 option slots. The following diagram shows the location of the DIP switch.

Note: Be sure to look closely at the default settings below. If you are connecting to an existing DeviceNet network, you may need to change the DeviceNet Baud Rate on your D0-DEVNETS. *The factory default baud rate is 125kbps.*

Installing the DeviceNet Slave Module

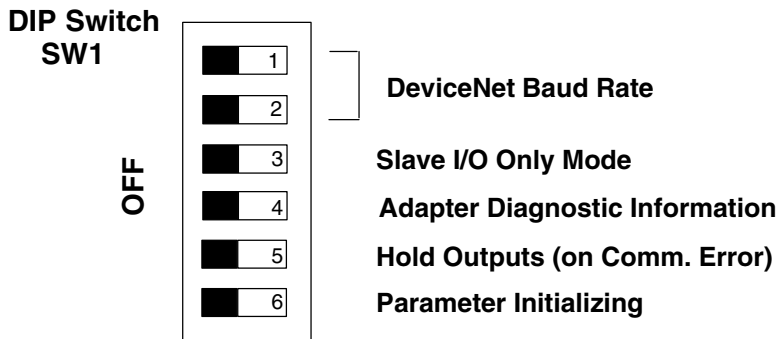
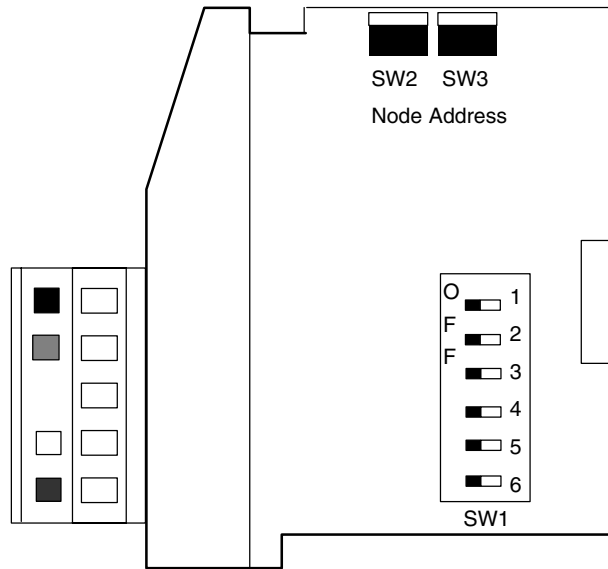

Set SW1-1 and SW1-2 for the DeviceNet baud rate.

DeviceNet Baud Rate		
Baud Rate	SW1-1	SW1-2
125 kbps	OFF	OFF
250 kbps	ON	OFF
500 kbps	OFF	ON
Reserved	ON	ON

Set the DL05/06 to Slave Mode.

When SW1-3 is ON, the DL05/DL06 can be placed in the RUN mode with the external RUN/TERM/STOP switch (with or without a program in it).

Slave I/O Only Mode	
Mode	SW1-3
Slave I/O only	ON
Normal	OFF

Eliminate adapter diagnostic information bits from I/O polling.

When SW1-4 is OFF D0-DEVNETS adds adapter information to the head of I/O polling.

Adapter diagnostic information	
Mode	SW1-4
Disable	ON
Enable	OFF



Note: Leaving position 4 OFF will add 2 bytes of inputs and 2 bytes of outputs for diagnostic information at the beginning of your I/O polling. Refer to the Adapter Input/Output Status Word tables on page C-8.

Position SW1-5 ON will hold the outputs on if there is a communication error.

Hold Outputs (on Comm. Error)	
Outputs	SW1-5
Turn Off	OFF
Hold	ON

Position SW1-6 ON will initialize the D0-DEVNETS system parameters.

Parameter Initializing		
Mode	SW1-6	Description
Initialize 1	ON	Default is set when power is ON *1
Initialize 2	OFF	

*1 Initialization parameter value changes with status of DIP switch positions 3 and 6. Refer to the Initialization Parameter Values table on page D-2.



Note: All DIP switch positions shown are the factory default settings (all OFF).

Remove the Slot Cover

When the D0-DEVNETS module is ready to be installed the protective option slot cover must be removed. The protective cover is removed from the option card slot by squeezing the pinch tabs and lifting the cover off.

Installing the DeviceNet Slave Module

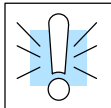
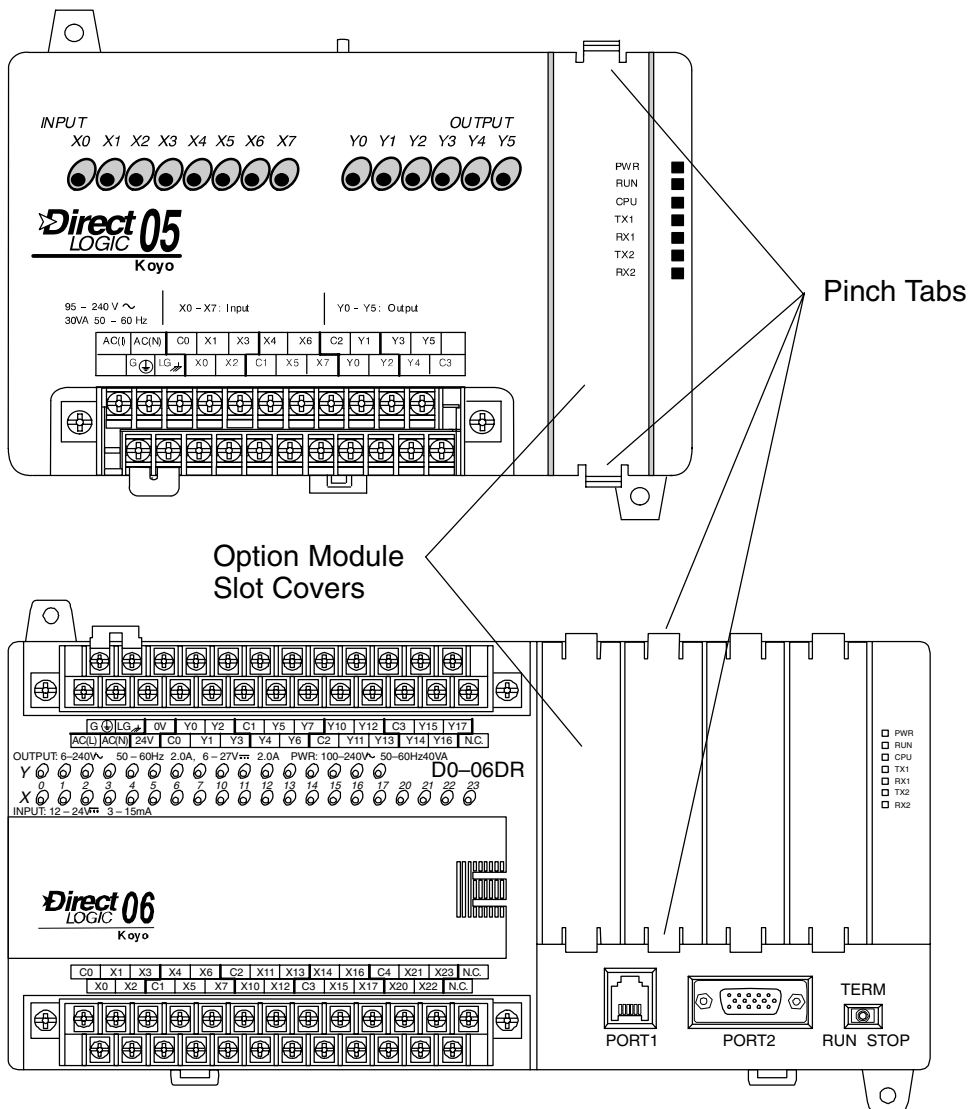

WARNING: Power to the PLC **must** be disconnected before inserting or removing the D0-DEVNETS slave module. Failure to disconnect power could result in serious damage to the module, the PLC or both.

Insert the Module

Insert the D0-DEVNETS slave module into the open card slot. Locate the module so the printed information is oriented in the same direction as the markings on the PLC. Be careful to align the female connector on the printed circuit board of the module with the male connector on the PLC mother board. Press the module into the slot until the front of the module is flush with the front of the PLC.

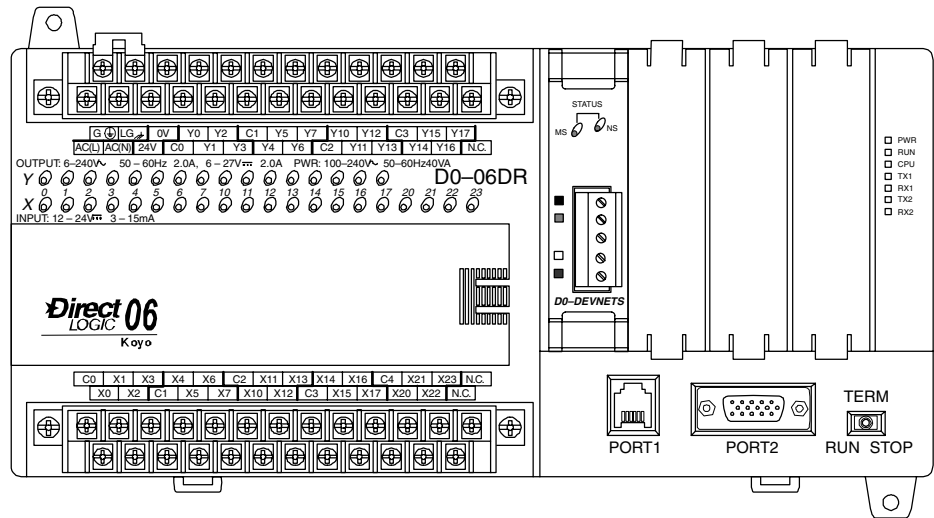
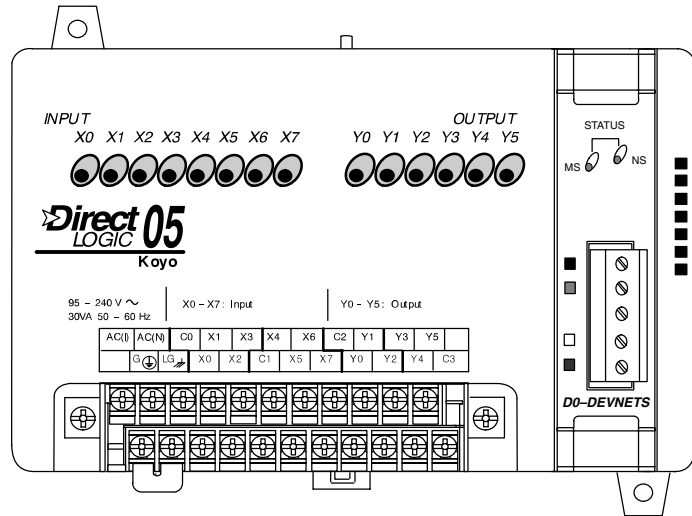

Installing the DeviceNet Slave Module

Set the Node Address

Once the D0-DEVNETS is installed in the option slot, set the Node Address. The Node Address rotary switches are accessed by removing the cover located to the right of Port1 and Port2 on the DL05.

Installing the DeviceNet Slave Module

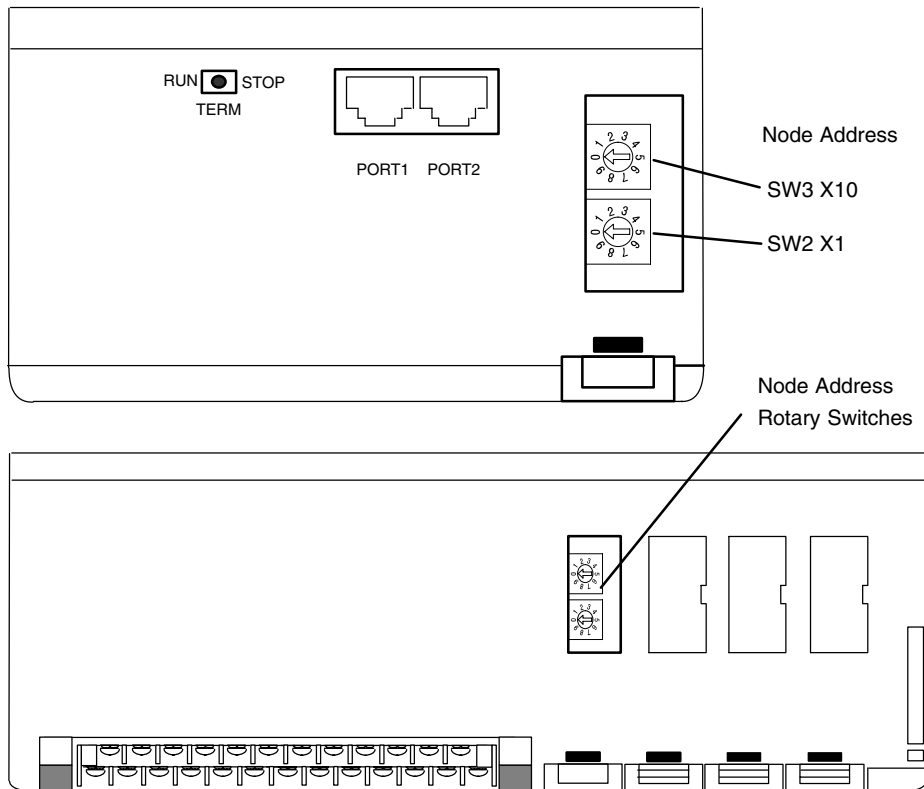

Remove the cover associated with the option slot where the D0-DEVNETS is installed in for the DL06 Once the access cover is removed, use a small, flat, screwdriver to set the Node Address to an *available* address (or MAC ID), from 0 – 63. Note that SW3 sets the tens and SW2 sets the units.

Wiring the Adapter to a DeviceNet Network

Connect the DeviceNet cable (Belden 3085A, YR-29832 or equivalent) to the removable connector as shown below. The wire colors are also labeled on the front of the adapter. Be sure to connect a terminating resistor (121 Ohm 1%, 1/4W). An external 11-25 VDC power supply is also required.

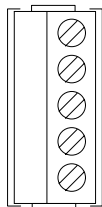

- V+ (red)
- CAN* High (white)
- Shield (bare)
- CAN* Low (blue)
- V- (black)

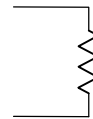

Connect a terminating resistor across the CAN High (white) and CAN Low (blue) screw terminals.

The terminating resistor is 121 Ohm 1%, 1/4 Watt. (2 resistors are included with each D0-DEVNETS).

* Controller Area Network (CAN)

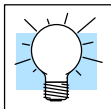

Tip: Be sure that each end of the DeviceNet network 'trunk' has a proper terminating resistor connected as shown above.

Configure the Adapter

Configuring the DeviceNet Adapter

Use the software of your DeviceNet master to configure the controller for your network. *Refer to the software Help file and/or manual for help with configuration.* Follow these basic steps when configuring your D0-DEVNETS adapter.

- 1. Set the Adapter Node Address:**
In the DeviceNet master software, make sure the adapter node address is set to an available node number on the DeviceNet network (from 0 to 63).
- 2. Add the EDS file (if required by the software):**
In your DeviceNet software, add the D0-DEVNETS Electronic Data Sheet (EDS) file from the disk which came with this manual or from our web site www.automationdirect.com. Some software may not provide for the use of EDS files.
- 3. Commission the Node:**
Use the DeviceNet software to “Commission the Node” of the adapter. Again, some software may not require this.
- 4. Add the D0-DEVNETS to the Scan List:**
Add the D0-DEVNETS to the Scan List in your DeviceNet Master software.
- 5. Set the Input/Output Bytes:**
If required by your DeviceNet software, set the I/O Parameters to Tx = Output bytes and Rx = Input bytes, for Polled I/O. *Follow the steps in Appendix G to determine the actual number of Output and Input bytes your system has.*
- 6. Map the I/O to the Master:**
Map the D0-DEVNETS I/O to the Scanner using Auto Map, or map the I/O to another location if desired.
- 7. Scan:**
Go Online (or Scan) to verify the configuration and check for errors.
- 8. View Indicators on the adapter:**
Refer to the Status Indicators when connecting to the network.

Status Indicators

The adapter has two Status Indicators, one for **Module Status** and the other for **Network Status**.

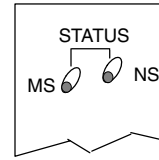

MS (Module Status) Indicator	
Indication	Status
OFF	No power to module.
Solid Green	Power is ON, normal condition
Solid Red	Critical module Failure
NS (Network Status) Indicator	
Indication	Status
OFF	No power to module or no Network Access
Flashing Green	Online but not connected (no connection established)
Solid Green	Online, link okay and connected
Flashing Red	Recoverable fault
Solid Red	Critical module Failure (Duplicate ID or Bus off)

D0-DEVNETS Parameter Setup

D0-DEVNETS Default Parameters The DL05/06 PLCs reserve several V-memory locations for storing the DEVNETS parameters. These special registers store the I/O ranges. The parameters are stored in the DL05/06 systems FLASH memory, and are not lost when the PLC is powered off.

System V-memory	Description of Contents	Factory Default Value	Range
V7610	Input starting address	V40400	V40400 – 40417 (X0-377) V40500 – 40517 (Y0-377) V40600 – 40637 (C0-777) V41000 – 41017 (S0 – 377) V41100 – 41107 (T0 – 177) V41140 – 41147 (CT0 – 177) V41200 – 41237 (SP0 – 777)
V7611	Input number of bytes	2 Bytes	0 – 8 Bytes
V7612	Output starting address	V40500	V40400 – 40417 (X0 – 377) V40500 – 40517 (Y0-377) V40600 – 40637 (C0-777) V41000 – 41017 (S0-377) V41100 – 41107 (T0 – 177) V41140 – 41147 (CT0 – 177) V41200 – 41237 (SP0 – 777)
V7613	Output number of bytes	2 Bytes	0 – 8 Bytes
V7614	Input starting V-memory location	V3000	V0 – 7777
V7615	Input V-memory number of bytes	58 Bytes	0 – 128 Bytes
V7616	Output starting V-memory location	V3100	V0 – 7377
V7617	Output V-memory number of bytes	52 Bytes	0 – 128 Bytes

Software and Firmware Requirements

How to Update Your *DirectSOFT32* Programming Software

When a D0-DEVNETS module is installed, the DL05/06 PLCs do not need to have a relay ladder logic (RLL) program in them to operate as slave I/O. However, if you are using the D0-DEVNETS in either a DL05 or a DL06 for local control on a network, they must have a RLL control program in them. You will need *DirectSOFT32* Version 3.0b (or later) for the DL05 and/or Version 4.0 for DL06 in order to use all features of the D0-DEVNETS. If you have a licensed copy of Version 3.0 or 3.0a, the Version 3.0b Maintenance Release (or a later maintenance release) is available for free on our website at www.automationdirect.com.

The DL05 must have Version 3.0 (or later) firmware and the DL06 must have Version 1.0 (or later) firmware to operate correctly with all features of the D0-DEVNETS. If your DL05/06 was received with your D0-DEVNETS, the correct firmware is already installed in the PLC. If you already have a DL05 and need to determine what firmware version is installed in the PLC, connect to the DL05 with *DirectSOFT32* programming software, and click on PLC/Diagnostics/System Information. This will bring up the System Information screen.

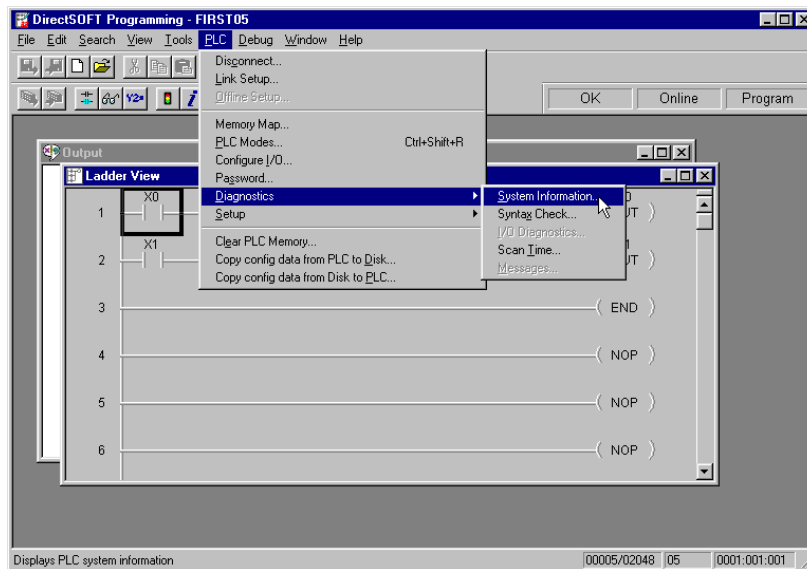

The “CPU Version:” will tell you what firmware version is installed in your PLC.

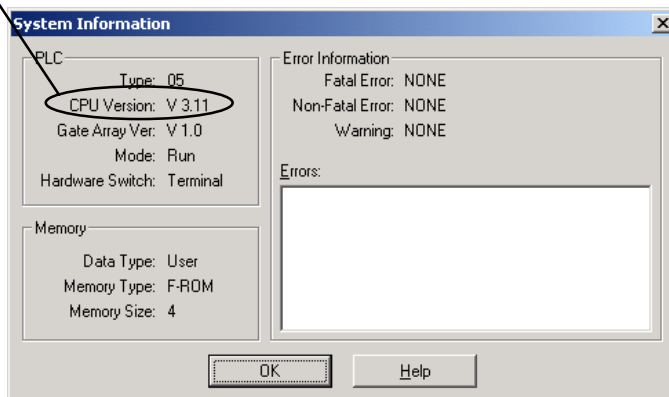

How to Update Your DL05 Firmware

If your PLC requires new firmware, you may download the latest firmware and upgrade tool from our website. Point your browser to www.automationdirect.com, click on technical support, then select Firmware Upgrades. There, you will find the latest firmware for your CPU, which you can download at no charge.

Follow the upgrade instructions contained in the downloaded files. Cycle power after upgrading the firmware in your PLC, and **DirectSOFT32** will recognize the new features available for the PLC.

Changing the D0-DEVNETS Setup Parameters

There may be a time when the initial setup parameters will need to be changed. The following example shows how to edit a DL05/06 PLC program to make the parameter changes using *DirectSOFT32* programming software. Once the following rung is edited, be sure to either power cycle the PLC or put the PLC into Program mode, then to Run mode. This will insure that the settings will become effective.

Parameter Example

Function	Register Number	Data Size
Input Point	V40400	2 Bytes
Output Point	V40500	2 Bytes
Input Register	V3000	128 Bytes
Output Register	V3100	128 Bytes

Installing the DeviceNet Slave Module

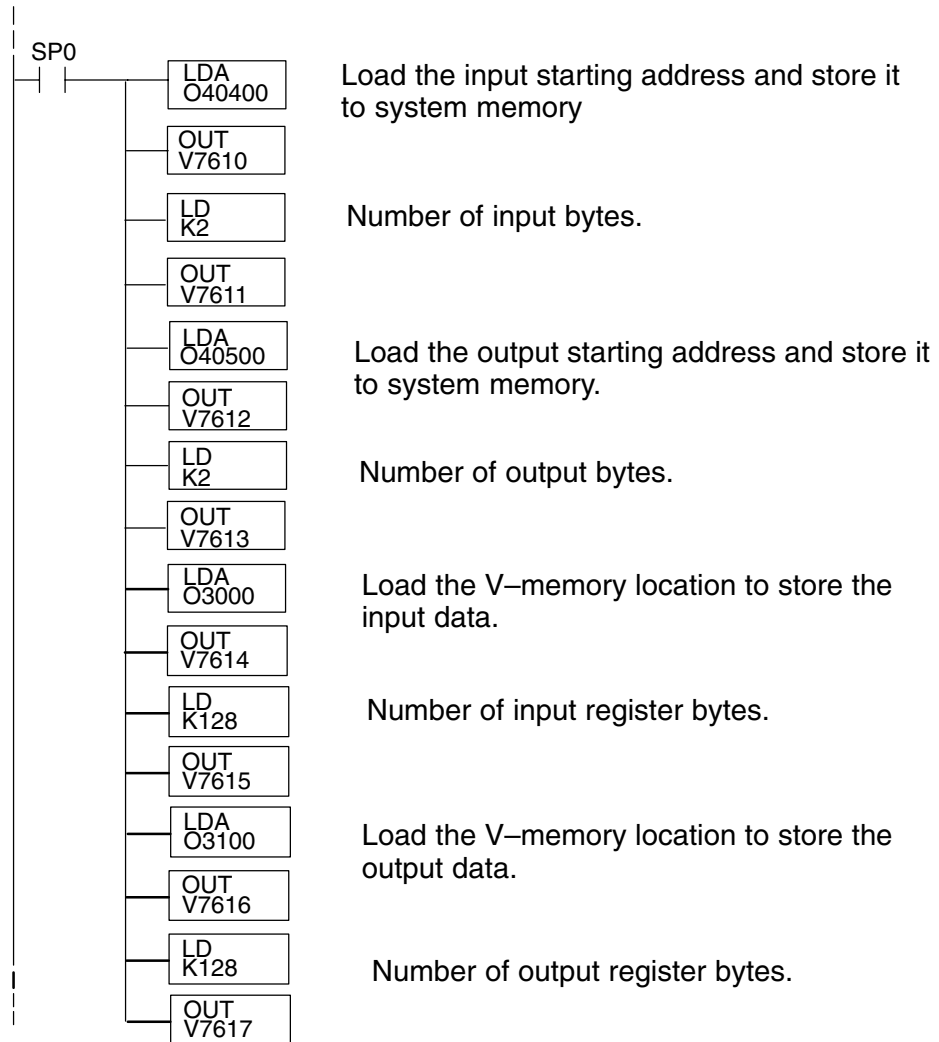

Specifications

In This Appendix. . . .
— Specifications

Specifications

General Specifications	
Ambient Operating Temperature	32°F to 131°F (0°C to 55°C)
Storage Temperature	-4°F to 158°F (-20°C to 70°C)
Ambient Humidity	5% to 95% non-condensing
Atmosphere	No corrosive gases, max. environmental pollution = 2, UL840
Vibration Resistance	MIL STD 810C, method 514.2
Shock Resistance	MIL STD 810C, method 516.2
Noise Immunity	NEMA ICS3-304 Impulse noise 1 μ s, 1000V FCC Class A RFI (144MHz, 430MHz, 10W, 10cm)
Size	0.78"W x 3.02"H x 2.12"D
Weight	1.75 oz. (50g)

Communication Specification	
Protocol	DeviceNet Communication (Slave)
Network address	0 to 63
Data Packet	0 to 8 Bytes (Data beyond eight bytes are divided.)
Baud Rate	125 kbps/250 kbps/500 kbps DIP Switch Setting
Maximum cable length	500m/125 kbps 250m/250 kbps 100m/500kbps
Parameter storage	FLASH Memory
Communication Status Indicator	MS : Module Status LED [Red/Green] NS : Network Status LED [Red/Green]
DeviceNet Power Consumption	11~25VDC 45mA Max.

DeviceNet Communication Details		
Device Type	Generic	
Explicit Peer to Peer Message	No	
I/O Peer to Peer Message	No	
Configuration Consistency	No	
Fault Node Recovery	No	
Communication Baud Rate 125K, 250K, 500K	Yes	
Master/Scanner	No	
I/O Slave Message	Bit Strobe	No
	Polling	Yes
	Cyclic	No
	Change of State (COS)	No

DeviceNet Object		
Item	Instance	Class Number
Identity Object	1	1h
Message Router Object	1	2h
DeviceNet Object	1	3h
I/O Assembly Object	5	4h
Connection Object	1	5h

Device I/O Specification	
I/O LINK	Inputs: 64 Points Outputs: 64 Points
I/O LINK Data Types Available	X, Y, C, S, T, CT, SP (Read Only)
Register LINK	128 Bytes Maximum: V0 – V7777
Other PLC Communication from Master	Only PLC Mode Selection (Mode SW is in TERM only)
Internal Power Consumption	45mA at 5VDC

Tables

In This Appendix. . . .
— DeviceNet Tables

Data Input and Output Tables

I/O Assembly Object is used for Data Transfer of the LINK register. I/O Assembly Object can access the data of the Input Point, Output Point, Input V-memory and Output V-memory. The I/O Assembly Object can also control the PLC Mode.

I/O Assembly CLASS = 4

Data Type	Instance	Attribute	Comment
Input Point	100	3	Read data from linking Input point.
Output Point	101	3	Write data to linking Output point.
Input Register	102	3	Read data from linking Input V-memory.
Output Register	103	3	Write data to linking Output V-memory.
PLC Mode	104	3	PLC Mode control (RUN/STOP)

Attribute Configure

The following tables describes each Link Register Attribute (Data Configure).

Input Point Attribute

Instance = 100 Attribute = 3

Name	Data		Address	Service	
	MSB	LSB			
Input Point	Input 07	_____	Input 00	+00	Get
	Input 17	_____	Input 10	+01	
	Input 27	_____	Input 20	+02	
	Input 37	_____	Input 30	+03	
	Input 47	_____	Input 40	+04	
	Input 57	_____	Input 50	+05	
	Input 67	_____	Input 60	+06	
	Input 77	_____	Input 70	+07	

One Input point is equal to one bit of the byte.

Eight bytes equals 64 Input points.

Output Point Attribute

Instance = 101 Attribute = 3

Name	Data		Address	Service	
	MSB	LSB			
Output Point	Output 07	_____	Output 00	+00	Set
	Output 17	_____	Output 10	+01	
	Output 27	_____	Output 20	+02	
	Output 37	_____	Output 30	+03	
	Output 47	_____	Output 40	+04	
	Output 57	_____	Output 50	+05	
	Output 67	_____	Output 60	+06	
	Output 77	_____	Output 70	+07	

One Output point is equal to one bit of the byte.
Eight bytes equals 64 Output points.

Input Register Attribute

Instance = 102 Attribute = 3

Name	Data	Address	Service
Input Register	Vn+00	+00	Get
	Vn+01	+02	
	Vn+02	+04	
	Vn+03	+06	
	Vn+04	+08	
	Vn+62	+124	
	Vn+63	+ 126	

The Data Register equals one Word (16 bits).
A maximum of 64 V-memory words can be accessed.

Output Register Attribute

Instance = 103 Attribute = 3

Name	Data	Address	Service
Output Register	Vn+00	+00	Set
	Vn+01	+02	
	Vn+02	+04	
	Vn+03	+06	
	Vn+04	+08	
	Vn+62	+124	
	Vn+63	+ 126	

The Data Register equals one Word (16 bits).
 A maximum of 64 V-memory words can be accessed.

PLC Mode Control Attribute

Instance = 104 Attribute = 3

Name	Data	Address	Service
PLC Mode	01: RUN request 02: STOP request	+00	Set
	00: STOP 03: RUN		Get

The PLC Mode can be read and requested to be changed.

Device Profile Tables

Identify Object (Class 1)

Instance 1 Attribute

Attribute	Item	Data type	Value	Service
1	Vendor ID	UINT	482	Get
2	Device Type	UINT	00	Get
3	Product Code	UINT	1500	Get
4	Major Revision	UINT	*	Get
	Minor Revision	UINT	*	
5	Status	WORD	*	
6	Serial Number	UDINT	****	Get
7	Product Name	SHORT-STRING	D0-DEVNETS	Get

Common Service

Service Code	Common Service
0E	Get_Attribute_Single
05	Reset

Device Net Object (Class 3)

Instance 1 Attribute

Attribute	Item	Data type	Value	Service
1	MAC ID	UINT	0 – 63	Get
2	Baud Rate	UINT	0 – 2	Get
4	BusOff Counter	UDINT	*	Get
5	Allocation Choice	BYTE	*	Get
	Master MAC ID	USINT	*	

Common Service

Service Code	Common Service
0E	Get_Attribute_Single

Connection Object (Class 5)

Slave Explicit Messaging Connection Object (Instance 1)

Attribute	Item	Data type	Value	Service
1	State	UINT	*	Get
2	Instance Type	UINT	00	Get
3	TransportClass_trigger	BYTE	83h	Get
4	Produced_connection_id	UINT	*	Get
5	Consumed_connection_id	UINT	*	Get
6	Initial_comm_characteristics	BYTE	21h	Get
7	Produced_connection_size	UINT	*	Get
8	Consumed_connection_size	UINT	*	Get
9	Expected_packet_rate	UINT	2500	Get
12	Watchdog_timeout_action	USINT	01	Get
13	Produced_connection_path_length	UINT	00	Get
14	Produced_connection_path	USINT	String	Get
15	Consumed_connection_path_length	UINT	00	Get
16	Consumed_connection_path	USINT	String	Get

Poll Connection Object (Instance 2)

Attribute	Item	Data type	Value	Service
1	State	UINT	*	Get
2	Instance Type	UINT	01	Get
3	TransportClass_trigger	BYTE	82h	Get
4	Produced_connection_id	UINT	*	Get
5	Consumed_connection_id	UINT	*	Get
6	Initial_comm_characteristics	BYTE	01	Get
7	Produced_connection_size	UINT	*	Get/Set
8	Consumed_connection_size	UINT	*	Get/Set
9	Expected_packet_rate	UINT	00	Get/Set
12	Watchdog_timeout_action	USINT	00	Get/Set
13	Produced_connection_path_length	UINT	6	Get
14	Produced_connection_path	USINT	20h,04,24h,40h,64h,03	Get/Set
15	Consumed_connection_path_length	UINT	6	Get
16	Consumed_connection_path	USINT	20h,04,24h,42,65h,03	Get/Set

Common Service

Service Code	Common Service
10h	Set_Attribute_Single
0E	Get_Attribute_Single

I/O Assembly Object (Class 4)

Instance Attribute

Instance	Attribute	Data type	Description	Bytes Maximum	Service
100	3	BIT	Input Data	8	Get
101	3	BIT	Output Data	8	Set
102	3	WORD	Input Register Data	128	Get
103	3	WORD	Output Register Data	128	Set
104	3	BYTE	PLC Mode	1	Get/Set

Common Service

Service Code	Common Service
10h	Set_Attribute_Single
0E	Get_Attribute_Single

Instance Attribute

Instance	Attribute	Bytes Maximum	Description	Data			Address	Service
				MSB7		LSB0		
100	3	8	Input Data	07	_____	00	+00	Get
				17	_____	10	+01	
				:	:	:	:	
				67	_____	60	+06	
				77	_____	70	+07	
101	3	8	Output Data	07	_____	00	+00	Set
				17	_____	10	+01	
				:	:	:	:	
				67	_____	60	+06	
				77	_____	70	+07	
102	3	128	Input Register Data	Vn+00			+00	Get
				Vn+01			+02	
				:			:	
				Vn+62			+124	
				Vn+63			+126	
103	3	128	Output Register Data	Vn+00			+00	Set
				Vn+01			+02	
				:			:	
				Vn+62			+124	
				Vn+63			+126	
104	3	1	PLC Mode	01:RUN Request			+00	Set
				02:STOP Request				
				00:STOP				Get
				03:RUN				

The DeviceNet standard is maintained by the ODVA (Open DeviceNet Vendor Association, Inc.). Contact the ODVA for detailed information about DeviceNet.
Internet: www.odva.org Email: odva@powerinternet.com

Image Table Mapping

In This Appendix. . . .
— Image Table Mapping

Image Table Mapping

Read, Write and Status Byte References

D0-DEVNETS can access data bytes.

Discrete Input

Discrete Input Point (X,Y,C,S,T,CT,SP) Image Table Mapping

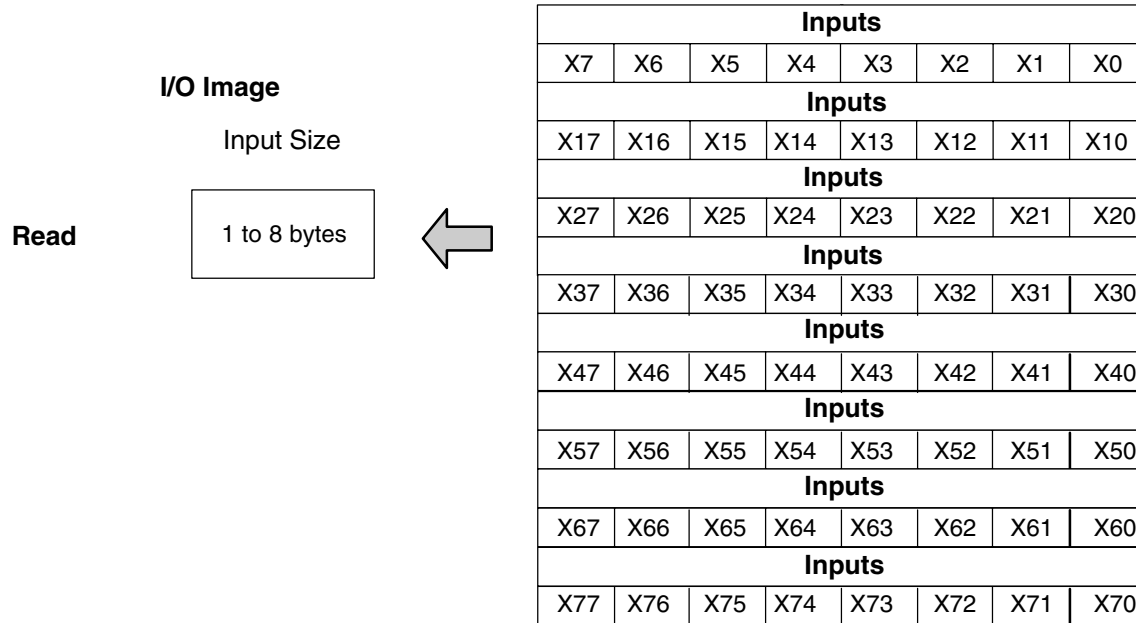

Dec. Bit	07	06	05	04	03	02	01	00	Size
Oct. Bit	07	06	05	04	03	02	01	00	
	X7	X6	X5	X4	X3	X2	X1	X0	Read Byte 1
	X17	X16	X15	X14	X13	X12	X11	X10	Read Byte 2
	X27	X26	X25	X24	X23	X22	X21	X20	Read Byte 3
	X37	X36	X35	X34	X33	X32	X31	X30	Read Byte 4
	X47	X46	X45	X44	X43	X42	X41	X40	Read Byte 5
	X57	X56	X55	X54	X53	X52	X51	X50	Read Byte 6
	X67	X66	X65	X64	X63	X62	X61	X60	Read Byte 7
	X77	X76	X75	X74	X73	X72	X71	X70	Read Byte 8
	Not Supported								Write Byte 1

Discrete Output Point (X,Y,C,S,T,CT,SP) Image Table Mapping

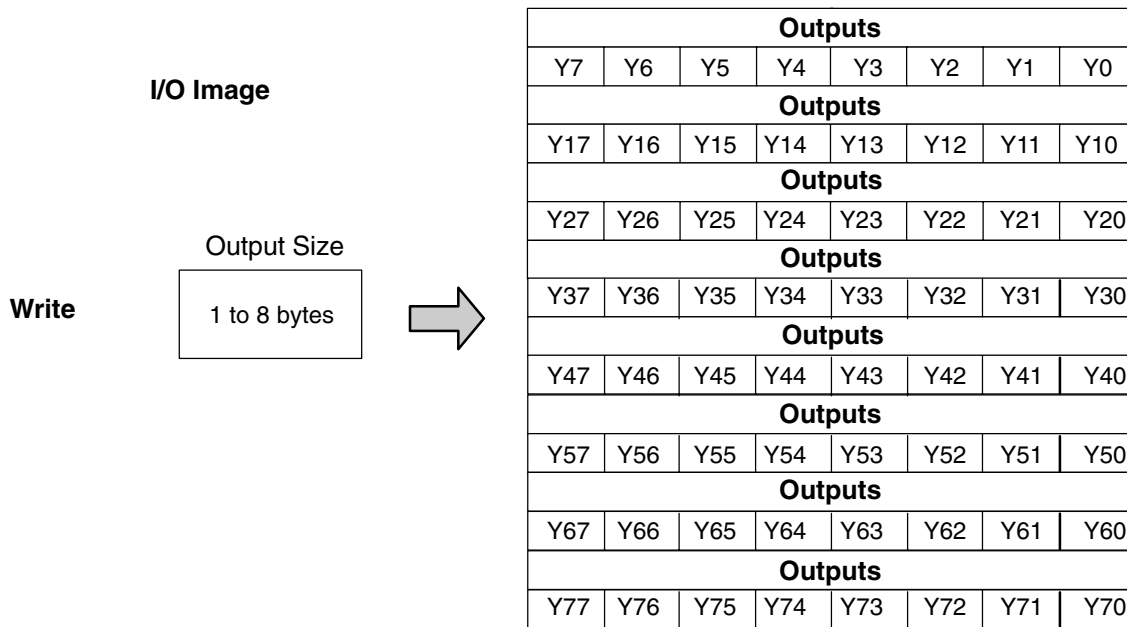

Dec. Bit	07	06	05	04	03	02	01	00	Size
Oct. Bit	07	06	05	04	03	02	01	00	Size
	Not Supported								Read Byte 1
	Y7	Y6	Y5	X4	Y3	Y2	Y1	Y0	Write Byte 1
	Y17	Y16	Y15	Y14	Y13	Y12	Y11	Y10	Write Byte 2
	Y27	Y26	Y25	Y24	Y23	Y22	Y21	Y20	Write Byte 3
	Y37	Y36	Y35	Y34	Y33	Y32	Y31	Y30	Write Byte 4
	Y47	Y46	Y45	Y44	Y43	Y42	Y41	Y40	Write Byte 5
	Y57	Y56	Y55	Y54	Y53	Y52	Y51	Y50	Write Byte 6
	Y67	Y66	Y65	Y64	Y63	Y62	Y61	Y60	Write Byte 7
	Y77	Y76	Y75	Y74	Y73	Y72	Y71	Y70	Write Byte 8

Register Input (V-memory) Image Table Mapping

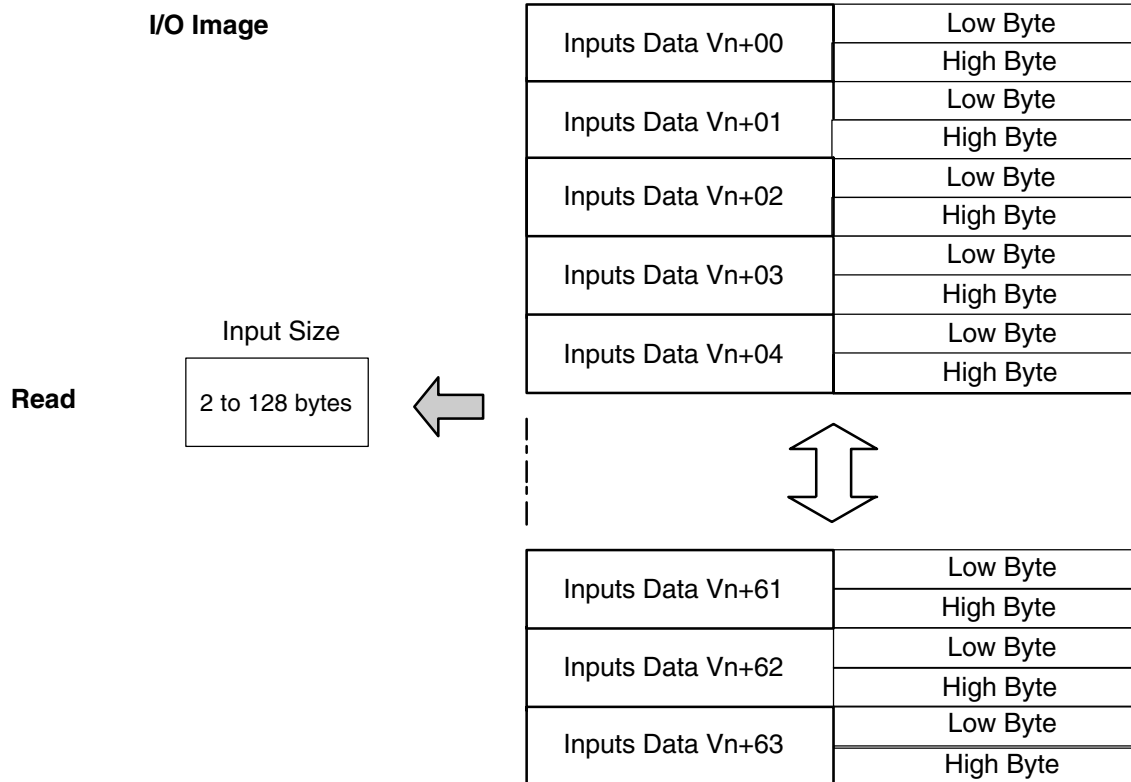

Decimal Bit	07	06	05	04	03	02	01	00	Size
Octal Bit	07	06	05	04	03	02	01	00	
	Vn + 00 V memory Low byte data								Read Byte 1
	Vn + 00 V memory High byte data								Read Byte 2
	Vn + 01 V memory Low byte data								Read Byte 3
	Vn + 01 V memory High byte data								Read Byte 4
	Vn + 02 V memory Low byte data								Read Byte 5
	Vn + 02 V memory High byte data								Read Byte 6
	Vn + 03 V memory Low byte data								Read Byte 7
	Vn + 03 V memory High byte data								Read Byte 8
	Vn + 04 V memory Low byte data								Read Byte 9
	Vn + 04 V memory High byte data								Read Byte 10
	Vn + 05 V memory Low byte data								Read Byte 11
	Vn + 05 V memory High byte data								Read Byte 12
	Vn + 06 V memory Low byte data								Read Byte 13
	Vn + 06 V memory High byte data								Read Byte 14
	Vn + 07 V memory Low byte data								Read Byte 15
	Vn + 07 V memory High byte data								Read Byte 16

	Vn + 08 V memory Low byte data	Read Byte 17
	Vn + 08 V memory High byte data	Read Byte 18
	Vn + 09 V memory Low byte data	Read Byte 19
	Vn + 09 V memory High byte data	Read Byte 20
	:	:
	:	:
	:	:
	:	:
	Vn + 30 V memory Low byte data	Read Byte 60
	Vn + 30 V memory High byte data	Read Byte 61
	Vn + 31 V memory Low byte data	Read Byte 62
	Vn + 31 V memory High byte data	Read Byte 63
	:	:
	:	:
	:	:
	:	:
	Vn + 60 V memory Low byte data	Read Byte 121
	Vn + 60 V memory High byte data	Read Byte 122
	Vn + 61 V memory Low byte data	Read Byte 123
	Vn + 61 V memory High byte data	Read Byte 124
	Vn + 62 V memory Low byte data	Read Byte 125
	Vn + 62 V memory High byte data	Read Byte 126
	Vn + 63 V memory Low byte data	Read Byte 127
	Vn + 63 V memory High byte data	Read Byte 128
	Not Supported	Write Byte 1

Register Output (V-memory) Image Table Mapping

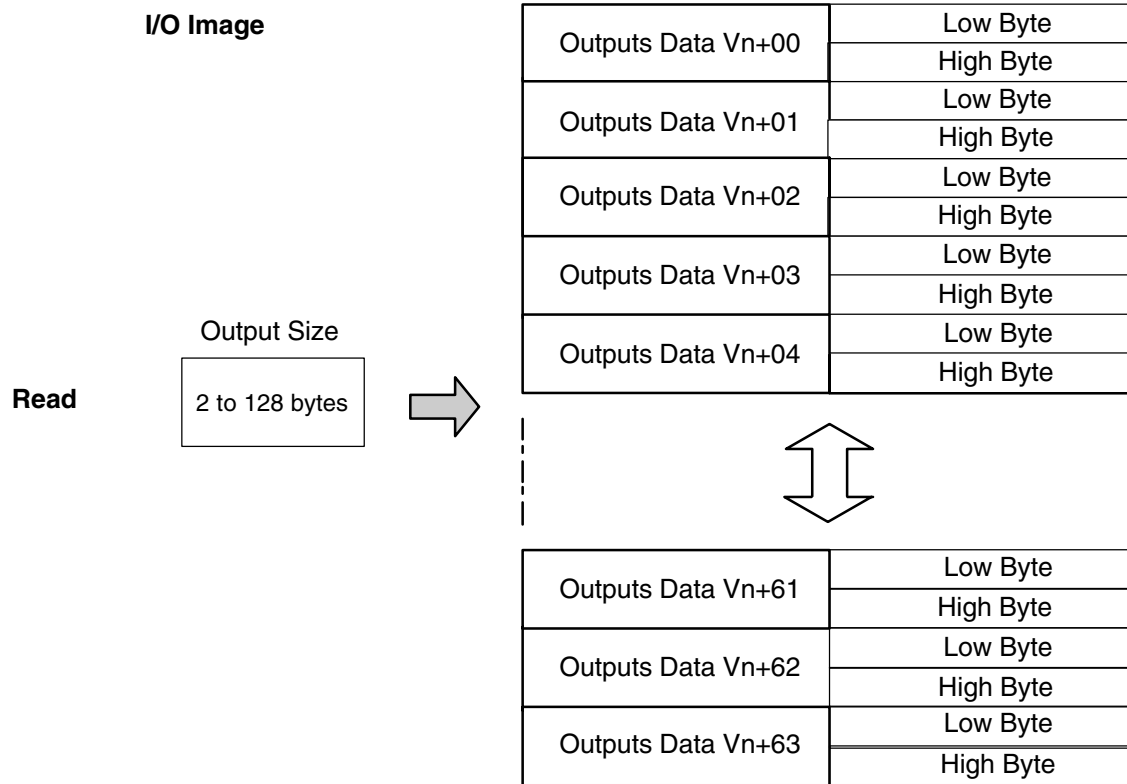

Decimal Bit	07	06	05	04	03	02	01	00	Size
Octal Bit	07	06	05	04	03	02	01	00	
	Not Supported								Read Byte 1
	Vn + 00 V memory Low byte data								Write Byte 1
	Vn + 00 V memory High byte data								Write Byte 2
	Vn + 01 V memory Low byte data								Write Byte 3
	Vn + 01 V memory High byte data								Write Byte 4
	Vn + 02 V memory Low byte data								Write Byte 5
	Vn + 02 V memory High byte data								Write Byte 6
	Vn + 03 V memory Low byte data								Write Byte 7
	Vn + 03 V memory High byte data								Write Byte 8
	Vn + 04 V memory Low byte data								Write Byte 9
	Vn + 04 V memory High byte data								Write Byte 10
	Vn + 05 V memory Low byte data								Write Byte 11
	Vn + 05 V memory High byte data								Write Byte 12
	Vn + 06 V memory Low byte data								Write Byte 13
	Vn + 06 V memory High byte data								Write Byte 14

	Vn + 07 V memory Low byte data	Write Byte 15
	Vn + 07 V memory High byte data	Write Byte 16
	Vn + 08 V memory Low byte data	Write Byte 17
	Vn + 08 V memory High byte data	Write Byte 18
	Vn + 09 V memory Low byte data	Write Byte 19
	Vn + 09 V memory High byte data	Write Byte 20
	:	:
	:	:
	:	:
	:	:
	Vn + 30 V memory Low byte data	Write Byte 61
	Vn + 30 V memory High byte data	Write Byte 62
	Vn + 31 V memory Low byte data	Write Byte 63
	Vn + 31 V memory High byte data	Write Byte 64
	:	:
	:	:
	:	:
	:	:
	Vn + 60 V memory Low byte data	Write Byte 121
	Vn + 60 V memory High byte data	Write Byte 122
	Vn + 61 V memory Low byte data	Write Byte 123
	Vn + 61 V memory High byte data	Write Byte 124
	Vn + 62 V memory Low byte data	Write Byte 125
	Vn + 62 V memory High byte data	Write Byte 126
	Vn + 63 V memory Low byte data	Write Byte 127
	Vn + 63 V memory High byte data	Write Byte 128

PLC Mode Image Table Mapping

I/O Image

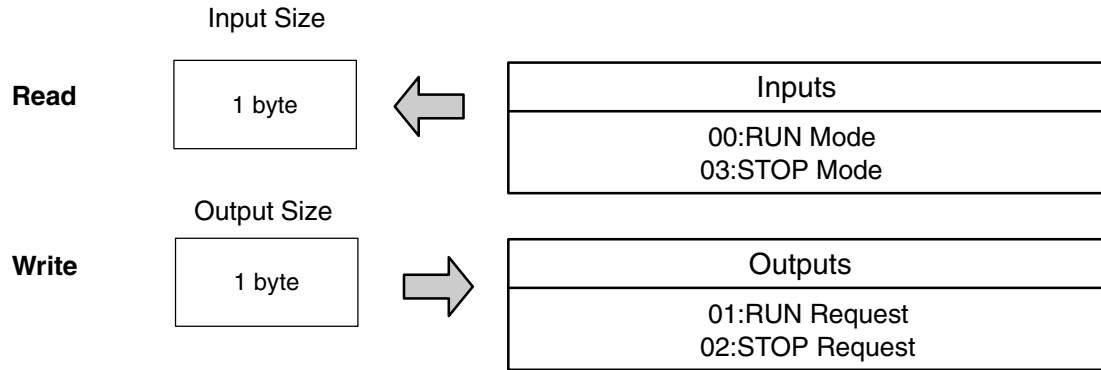

Dec. Bit	07	06	05	04	03	02	01	00	Size
Oct. Bit	07	06	05	04	03	02	01	00	
RUN Request	0	0	0	0	0	0	0	1	Read Byte 1
STOP Request	0	0	0	0	0	0	1	0	
STOP RUN	0	0	0	0	0	0	0	0	Write Byte 1

Adapter Input/Output Status Word

Polling format that the DO-DEVNETS (slave) transmits to a master.

Address	Bytes	Data	Comment
+ 0	1	I/O Status	Bit 0: Not used Bit 1: Not used Bit 2: Not used Bit 3: Node Error (Node number has changed) ON: Error/OFF: Normal Bit 4: IDLE (Output is IDLE) ON: Idle/OFF: Normal Bit 7: OUTPUT Status ON: Enable/OFF: Disable
+ 1	1	PLC Mode	00: Mode = STOP 03: Mode = RUN

Polling format that a master transmits to a DO-DEVNETS (slave).

Address	Bytes	Data	Comment
+ 0	1	No Code	No request
		C3h	Enable OUTPUT
		3Ch	Disable OUTPUT
+ 1	1	PLC Mode	01: RUN request 02: STOP request

Special Relays and DIP Switch Parameter Initializing

In This Appendix. . . .

- Special Relays
 - DIP Switch Parameter Initializing
-

Network Status Special Relays

The DL05 has special relays which allows the D0-DEVNETS to monitor the network status. These relays are SP120 and SP121.

SP	Condition	Details
SP120	ON	Communicating
	OFF	No communication
SP121	ON	Communication error
	OFF	Normal

Initializing Parameter Values

The values of the system parameter registers, V7610 – V7617, can be changed and initialized by the position of DIP switches SW1-3 and SW1-6.

Parameter values when the DL05/06 is powered up.

SW-3	SW1-6	V7610	V7611	V7612	V7613	V7614	V7615	V7616	V7617
OFF	OFF	*1	*1	*1	*1	*1	*1	*1	*1
OFF	ON	O40400	2	O40500	2	O3000	128	O3100	128
ON	OFF	O40400	2	O40500	2	O3000	58	O3100	52
ON	ON	O40400	2	O40500	2	O3000	128	O3100	128

*The parameter value in the EEPROM is moved to a register.

D0-DEVNETS Think & Do/Entity Setup

In This Appendix. . . .

— D0-DEVNETS Think & Do/Entity Setup

D0-DEVNETS Think & Do/Entivity Setup

For those who are using the D0-DEVNETS as slave I/O with Think & Do Studio PC based control, the following example shows how to setup Think & Do on your network.

T&D/Entivity setup for PC control

Use the following procedure to setup the D0-DEVNETS adapter with Think & Do Studio.

1. Click on Add Driver and SST card is installed.
2. Set MAC ID to 62.
3. Set baud rate to either 125k or 250k.
4. Set scanner interval to 0.
5. Set timeout shutdown to 5.
6. EDS not needed.

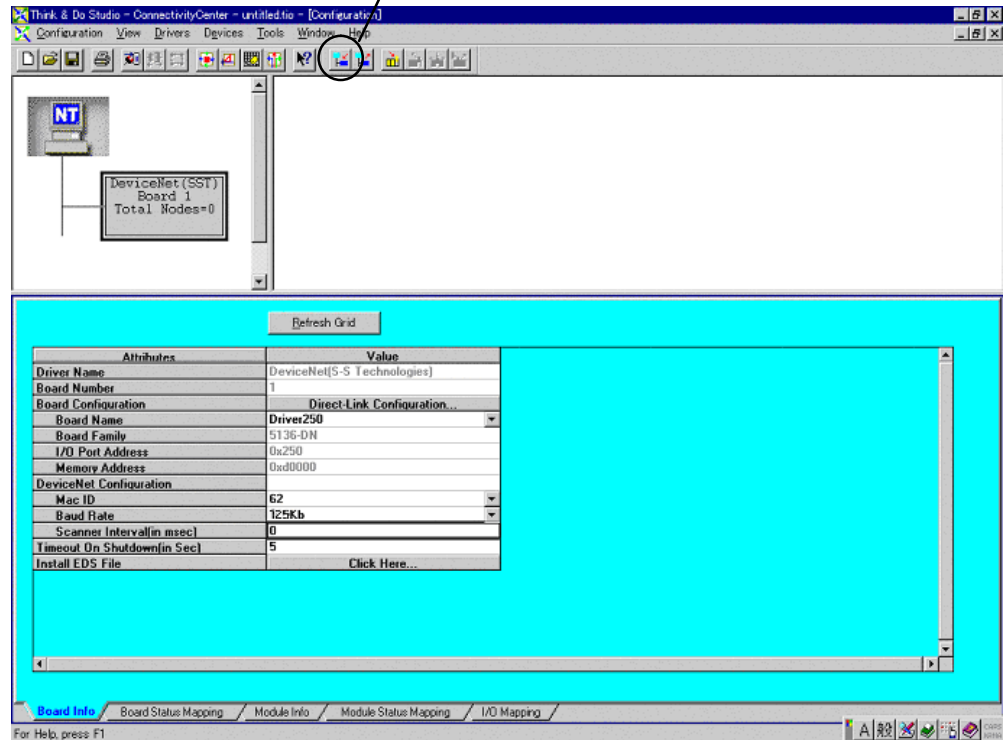

7. Click on connection.

Think & Do/Entropy will display D0-DEVNETS MacID #.
PIn and POut will display 32 points each.

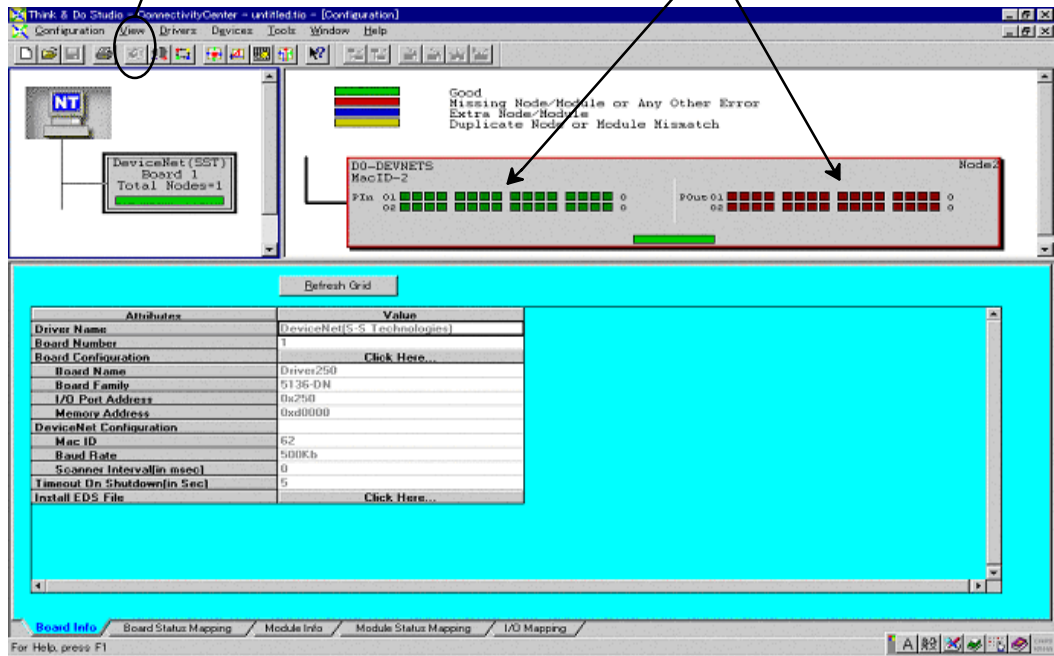

8. Click on Scan and communication will begin.

PIn 01 will display diagnostic data.

POut 01 controls D0-DEVNETS.

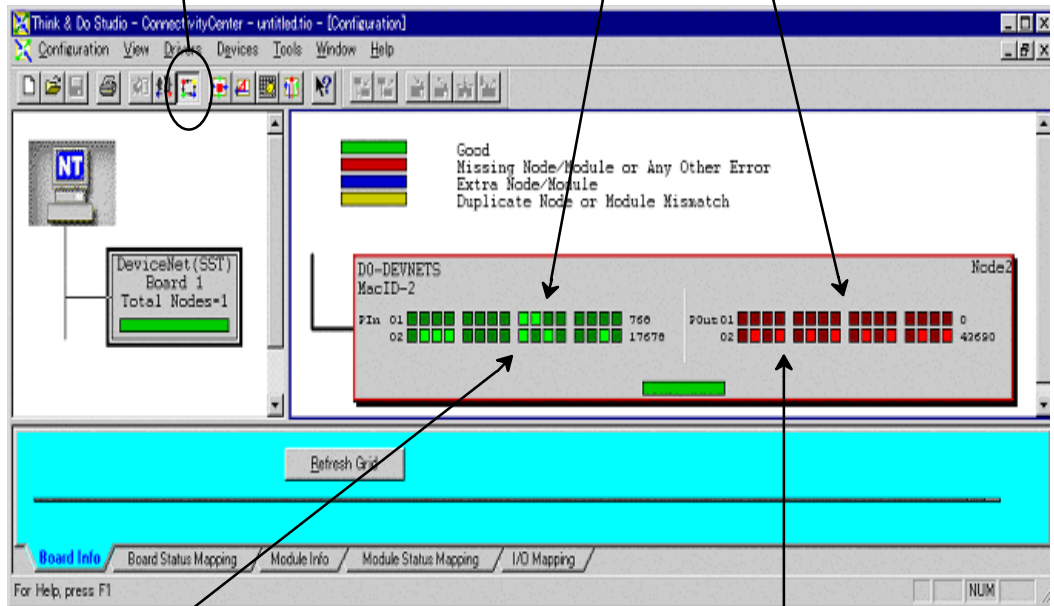

Inputs X0-X7 (V40400) will display on bits 0-15 of PIn 02.

Outputs Y0-Y15 (V40500) will display, and bits 0-15 of POut 02 can be forced ON/OFF.

For those who are using a DL05 with D0-DEVNETS as a PLC, for local I/O control, on a DeviceNet network with Think & Do Studio, the following example shows how to setup the DL05 and the adapter for use as a PLC on the network.

Setup Think & Do with DL05 on a network

Use the following steps to setup the adapter with the DL05 PLC for local control on a network. The RLL program is edited using *DirectSOFT32* programming software.

Set DIP switch, SW1, as follows:

1. SW1-1: OFF
SW1-2: ON (communications rate 500K or the baud rate of your choice)
SW1-3: OFF
SW1-4: OFF
SW1-5: OFF
SW1-6: ON (initial value)

SW1-6 sets up the following system parameter defaults:

V7610 = O40400 / V7611 = 2
V7612 = O40500 / V7613 = 2
V7614 = O3000 / V7615 = 128
V7616 = O3100 / V7617 = 128

2. Set rotary switch, SW2 = 02, SW3 = 0.
3. Add the following RLL code to the DL05 program:

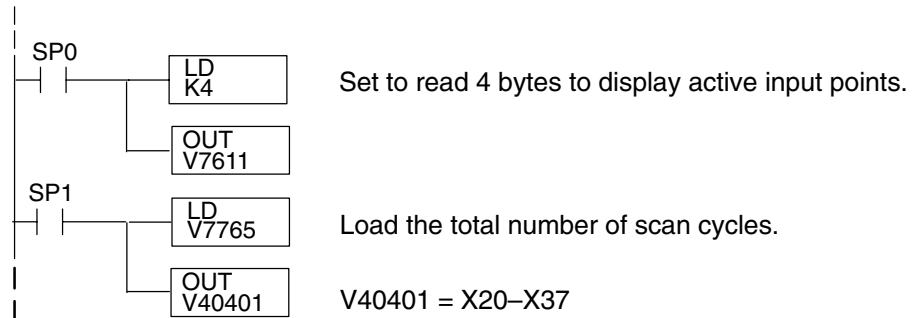

4. Return the DL05 to RUN mode.

T & D Studio setup Use the following procedure to setup the D0-DEVNETS adapter with Think & Do Studio.

1. Click on Add Driver and SST card is installed.
2. Set MAC ID to 62.
3. Set baud rate (500K in this example).
4. Set scanner interval to 0.
5. Set timeout shutdown to 5.
6. EDS not needed.

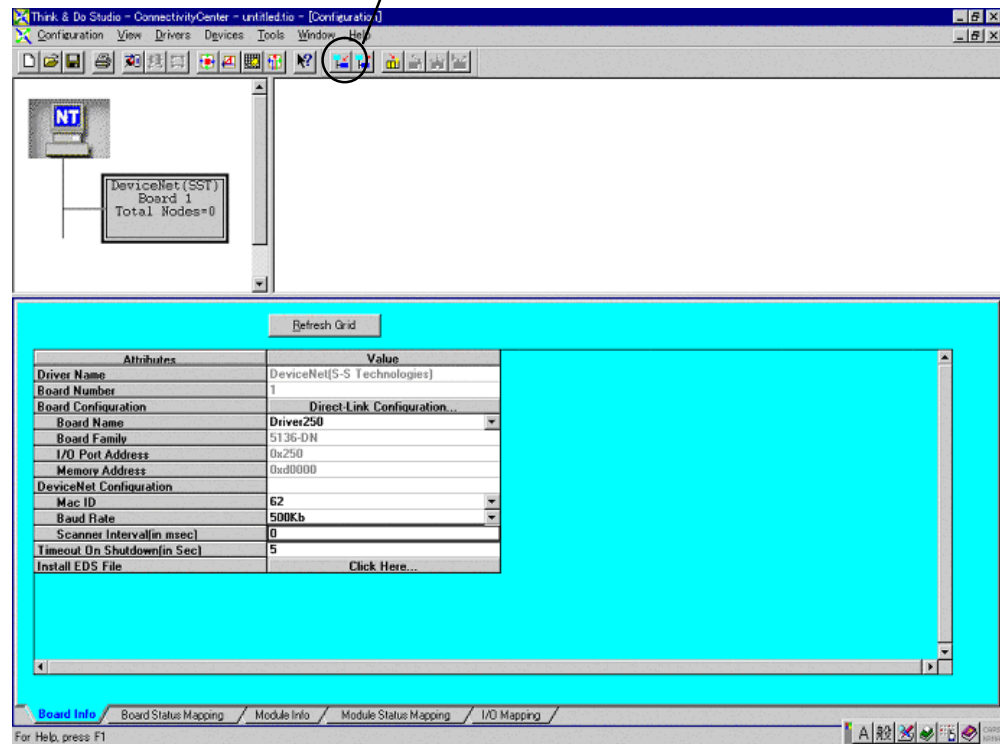

7. Click on connection.

8. Click on Scan and communication will be setup.

PIn 01 is system information.

P0ut 01 controls D0-DEVNETS.

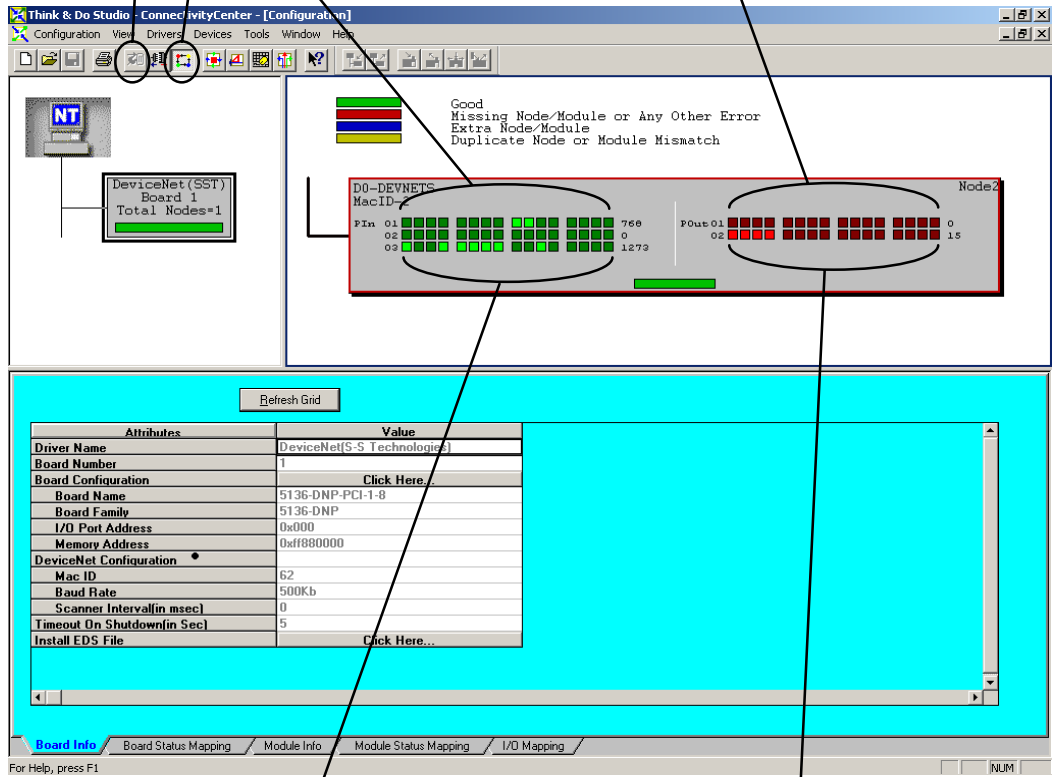

PIn 02 is V40400 and PIn 03 is linked to V40401 which shows the active inputs.

P0ut 02 is linked to V40500.

Using the DL05 PLC example will allow easy access to other bits in the PLC without using explicit messaging. Polling is often faster than explicit messaging.

The following example is a DL06 PLC with the following I/O modules installed:

- Slot 1 = D0-16ND3
- Slot 2 = F0-2AD2DA-2
- Slot 3 = D0-10TD2
- Slot 4 = D0-DEVNETS

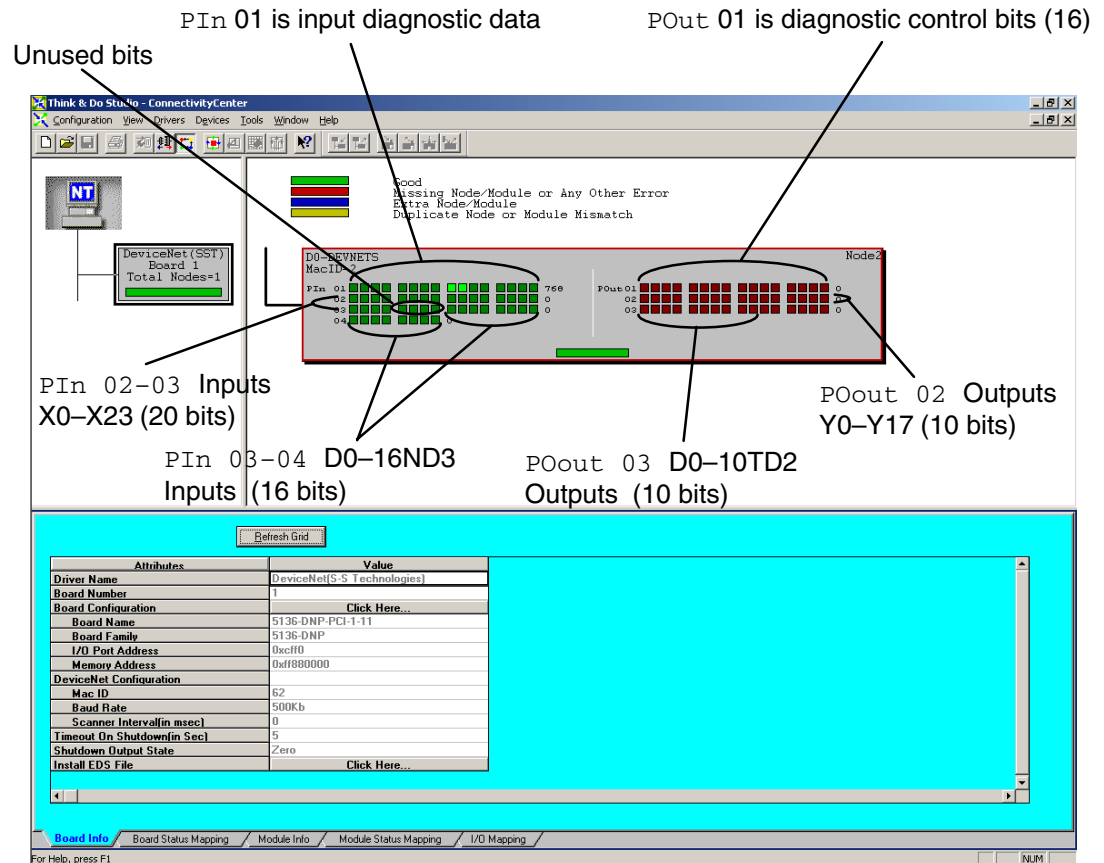

PIn 01 shows the input diagnostic data (16 bits). PIn 02, linked to V40400, and the first four bits of PIn 03 are the DL06 integrated inputs (X0-X23 octal = 20 bits). The next four bits are not used. The last eight bits of PIn3 are the first eight inputs of the D0-16ND3 and PIn 04 are the last eight inputs of the D0-16ND3.

POut 01 are the diagnostic control bits for D0-DEVNETS. POut 02, linked to V40500, shows the 16 integrated outputs of the DL06 (Y0-Y17 octal), and POut 03 are the bits for the D0-10TD2 output points.

This is how the display appears after scanning begins. Notice the end points for the DL06 integrated I/O. Only the discrete I/O is polled. Analog I/O is setup in registers (See page 2-11).

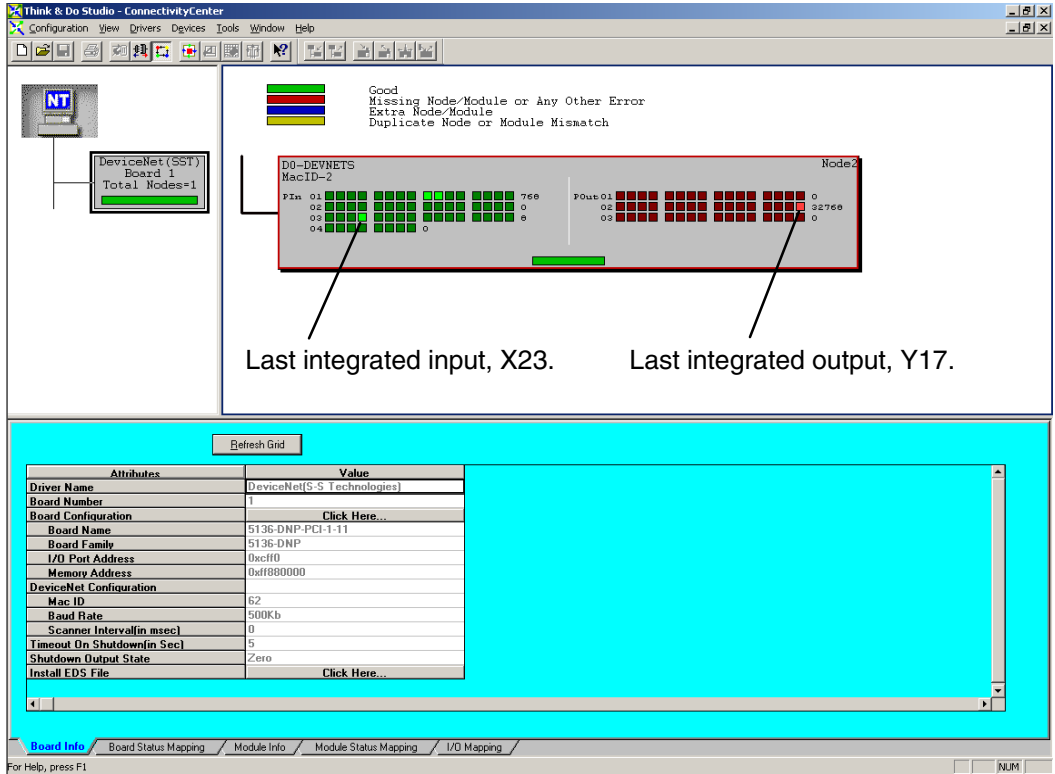

Polled I/O

Byte	I/O Point								Address
PIn 02	X7	X6	X5	X4	X3	X2	X1	X0	V40400
PIn 02	X17	X16	X15	X14	X13	X12	X11	X10	V40400
PIn 03	NA	NA	NA	NA	X23	X22	X21	X20	V40401
PIn 03	X107	X106	X105	X104	X103	X102	X101	X100	V40401
PIn 04	X117	X116	X115	X114	X113	X112	X111	X110	V40402
POut 02	Y7	Y6	Y5	Y4	Y3	Y2	Y1	Y0	V40500
POut 02	Y17	Y16	Y15	Y14	Y13	Y12	Y11	Y10	V40500
POut 03	Y107	Y106	Y105	Y104	Y103	Y102	Y101	Y100	V40501

OIT with D0-DEVNETS

In This Appendix. . . .

— OIT with D0-DEVNETS and Think & Do/Entity

Using an OIT with D0-DEVNETS

An Operator Interface Terminal (OIT) can be used on your DeviceNet network. The example used here is for a D0-DEVNETS installed in a PLC on a DeviceNet network. The network is controlled by a PC, with an SST module installed and using Think & Do Studio. The OIT is an EZTouch unit connected to a DL05 PLC. The PLC does not have a RLL program in it.

T&D Studio

You will first map the DeviceNet status.

Connect to the D0-DEVNETS on the DeviceNet network, select **Board Status Mapping** so the status items can be mapped. Map the data and provide a tag name for each item.

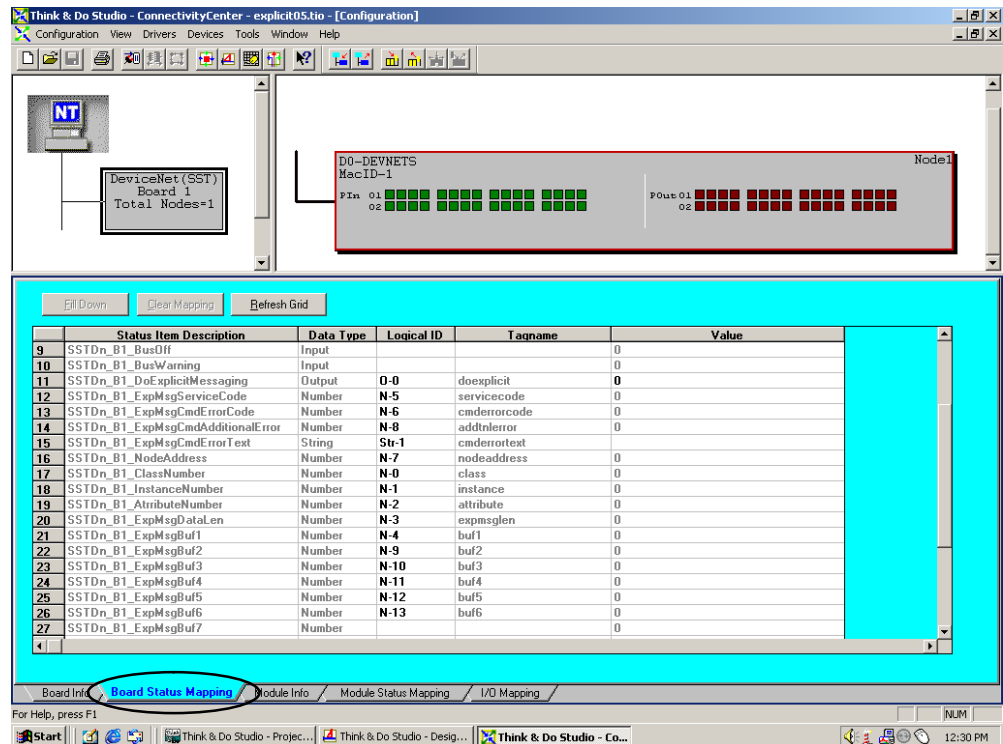

Our example uses three flowcharts. Flowchart 1 Gets the data, flowchart 2, entitled Parsing, breaks down the data and flowchart 3 Sends the data. We will select **GetUpdateOn** first.

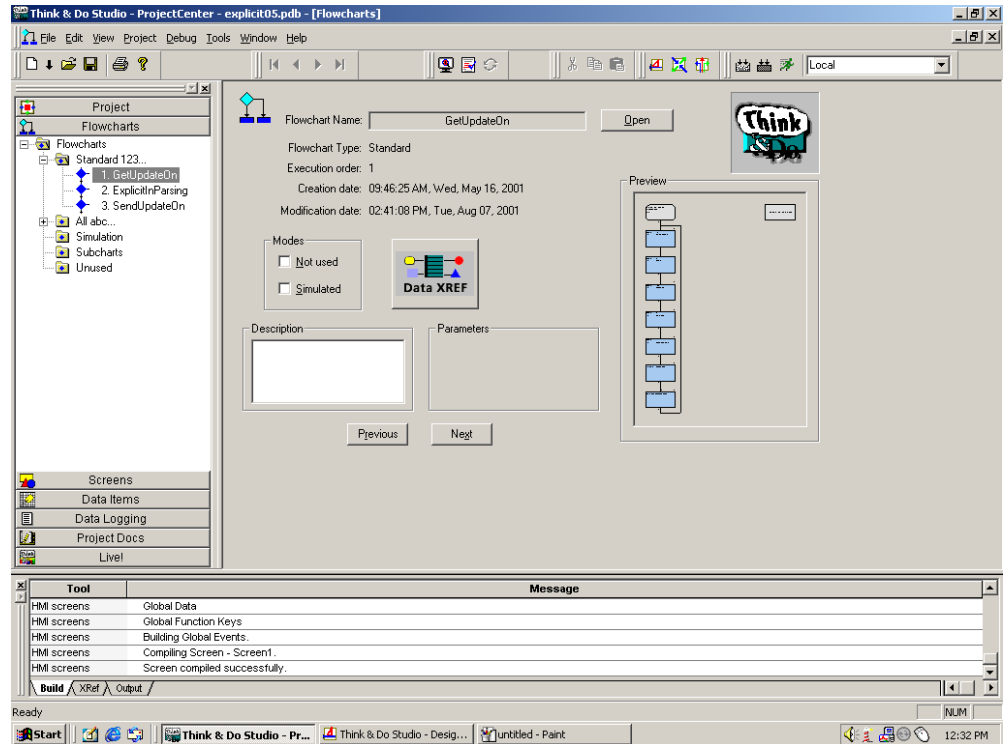

This flowchart shows how to set up explicit messaging to Get (receive) the data. Once the explicit messaging is done, it normally turns off, but in this example, the last block provides a 500 millisecond delay which allows the explicit messaging to turn on again.

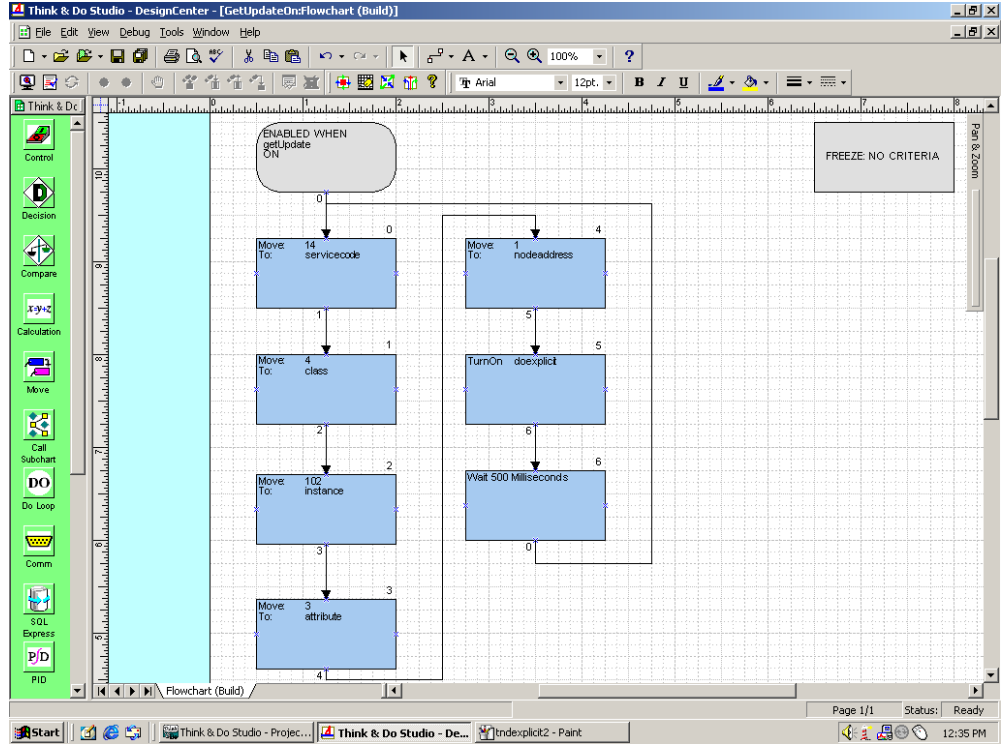

Refer to the DeviceNet tables located in Appendix B when creating your flowcharts.

Since Think & Do Studio has 32 bit registers, the 32 bits must be broken down into two 16 bit registers in order to transmit (send) the correct data to the PLC. This flowchart, Parsing, shows how it is done.

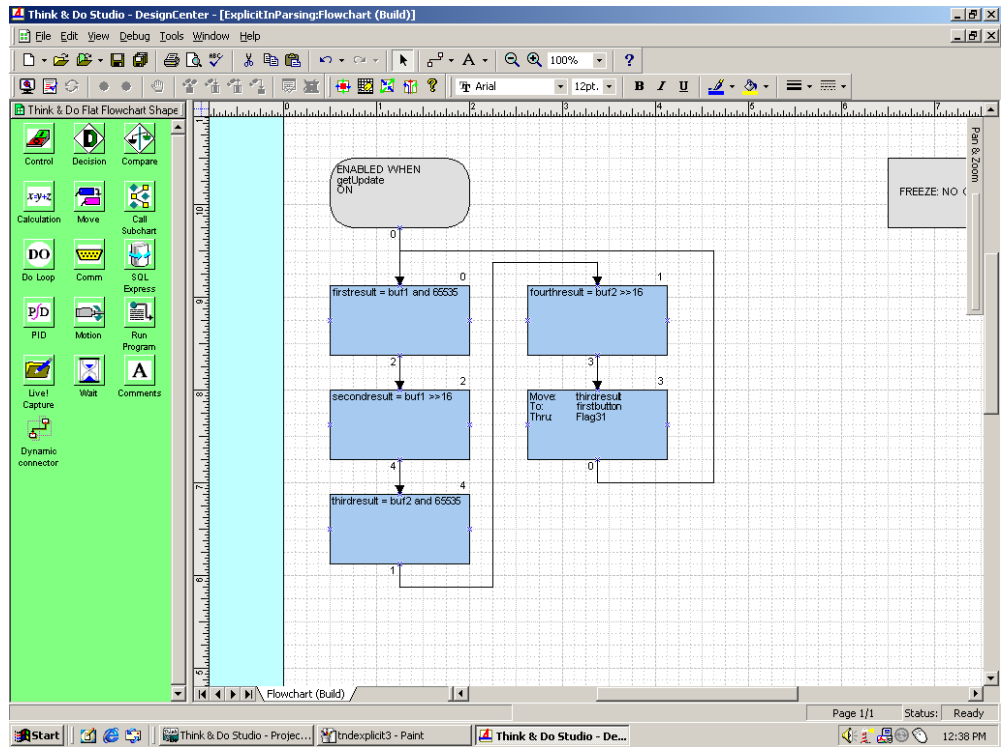

This flowchart, **SendUpdateOn**, shows you how to put the data into a send (transmit) buffer. The data gets cleared out of the buffer whenever each explicit messaging is done, therefore, data needs to be loaded into the buffer before each explicit messaging is turned on. Notice that this flowchart uses a 500 millisecond wait block to allow the explicit messaging to turn on continuously.

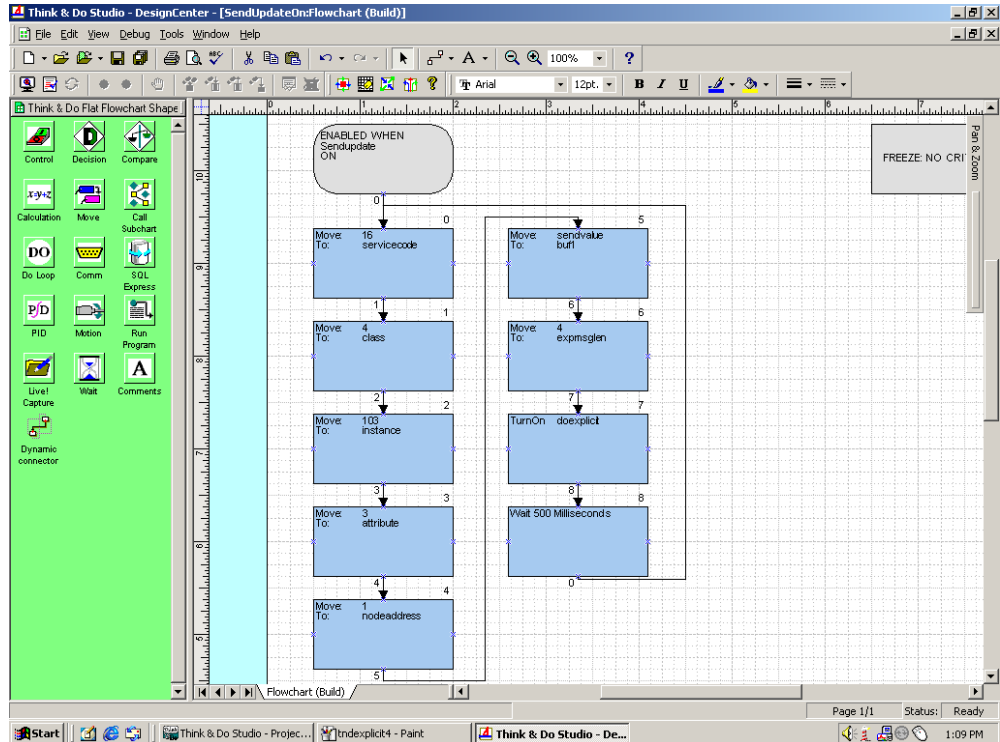

After Think & Do has been setup, the EZTouch panel can be connected to the DL05/06 serial port. Match the communications settings in the EZTouch software to the settings for the DL05/06 serial port setup.

From the development screen, select **Setup** then **PLC...**

Refer to the diagram below.

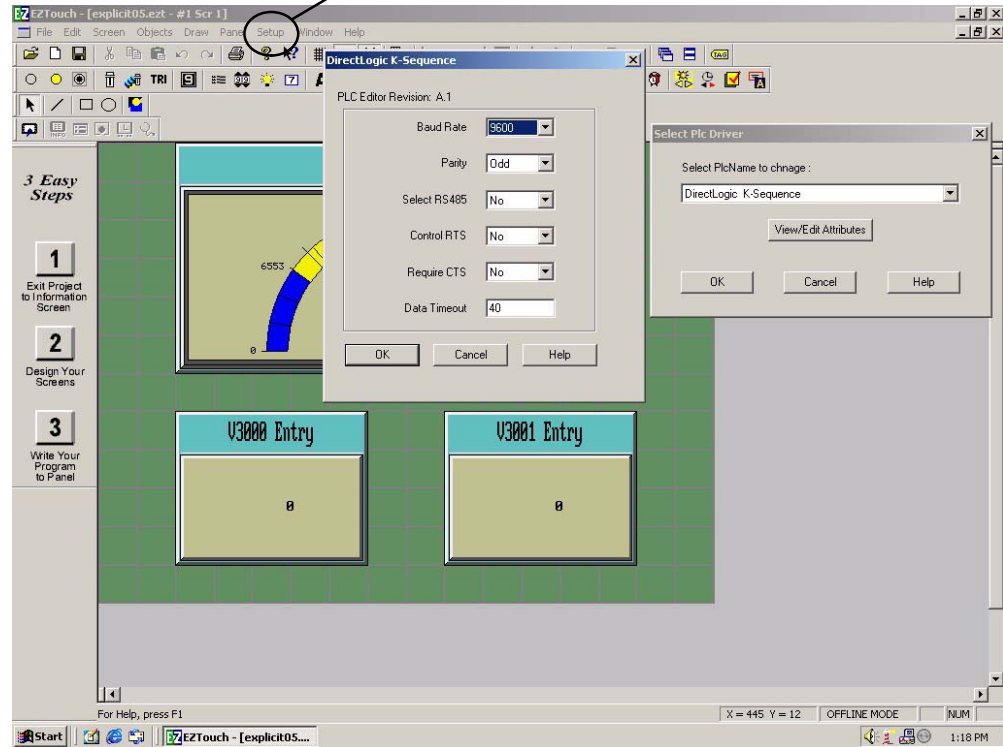

This is an example of a meter display and two numeric entry parts showing the use of the default V-memory input and output locations.

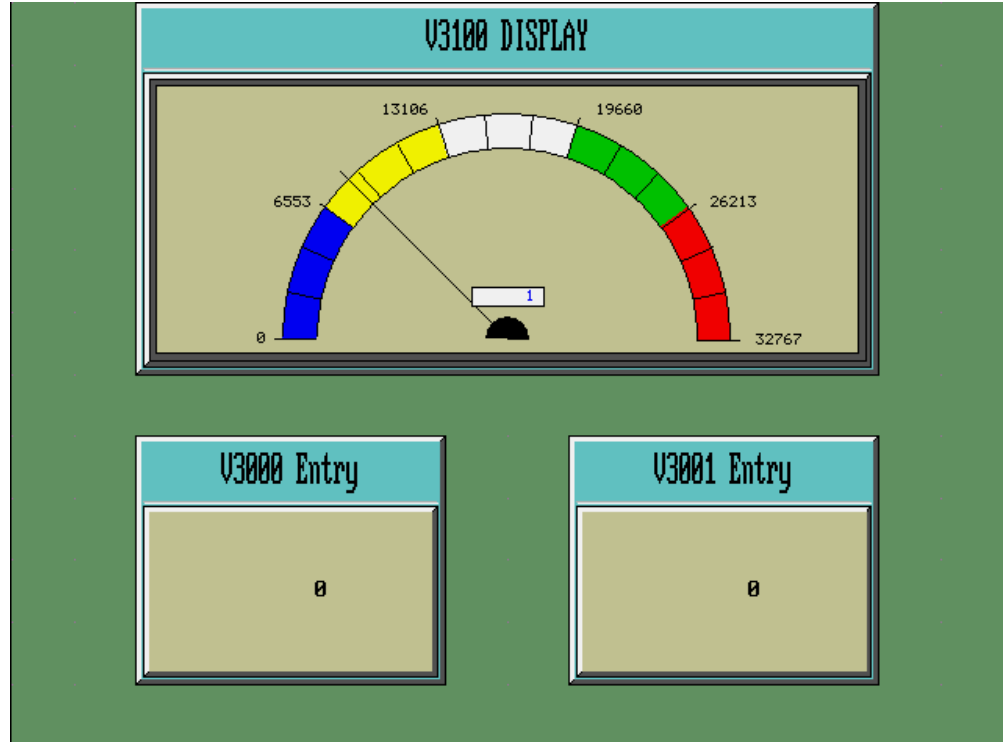

Finish the EZTouch display by completing the input and output information. Consult the EZTouch User Manual or the EZTouch help menu for more details.

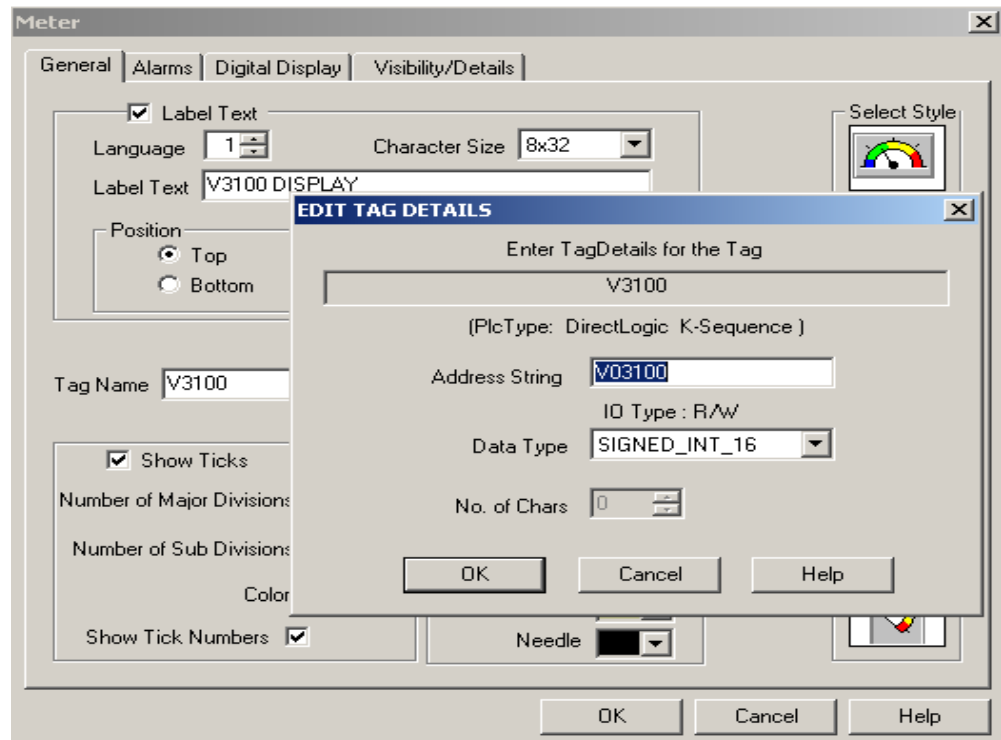
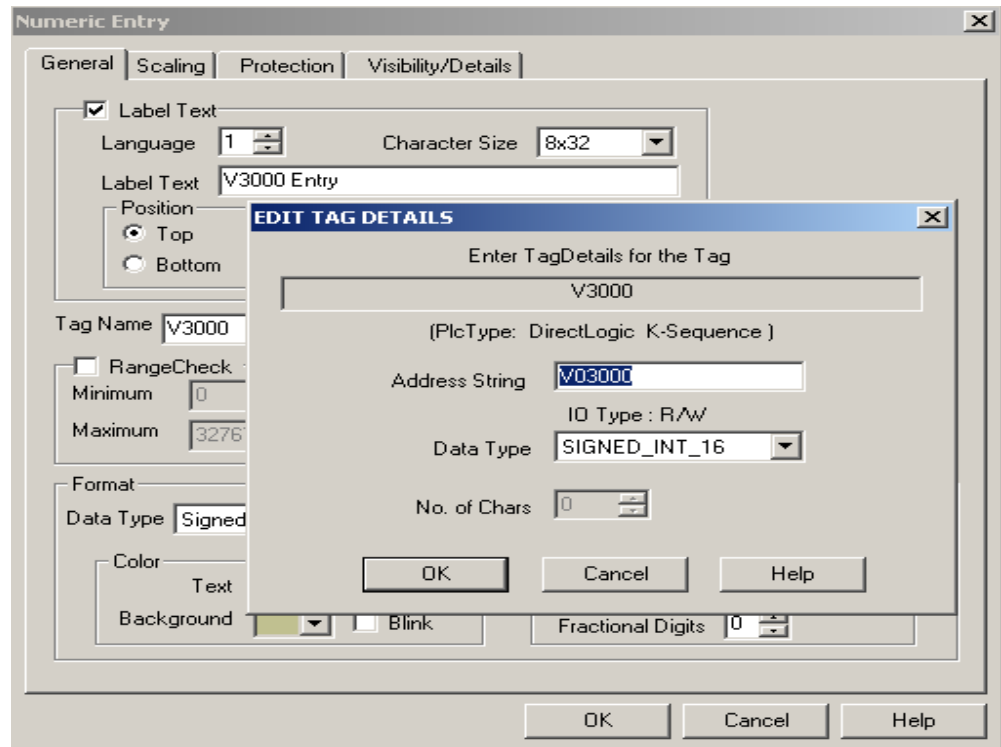

D0-DEVNETS and Allen-Bradley Set up

In This Appendix. . . .

— Setup D0-DEVNETS with Allen-Bradley RSNetwork[™]

Setup D0-DEVNETS with Allen-Bradley RSNetWorx™

For those who are using the D0-DEVNETS as a slave with an Allen-Bradley PLC, the examples on the following pages will step you through the process of setting up your Allen-Bradley DeviceNet network using RSNetWorx™.

RSLinx

Begin by opening your RSLinx to configure the DeviceNet driver.

1. Click on **Communications**.
2. Click on **Configure Drivers**.

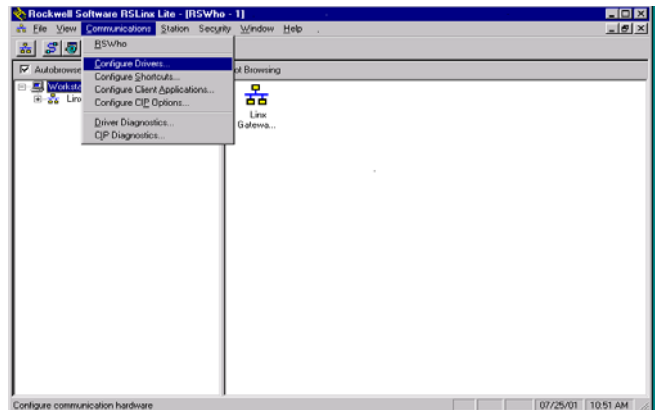

3. Click on the down arrowhead, ▼, and select a driver from the drop-down list.
4. Click **Add New**.

A DF1 driver is selected in this example.

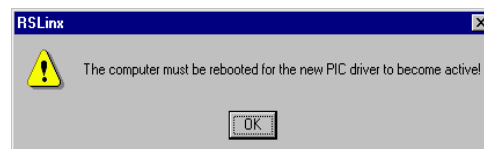
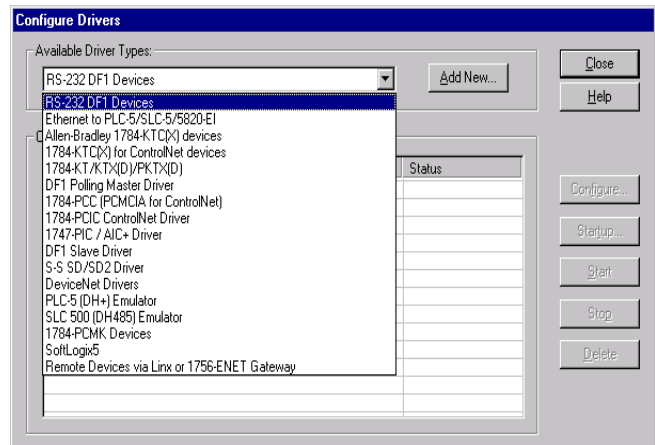

Note: Selecting a new driver may prompt you to reboot or to restart your computer.



5. Click **OK** in the pop-up window.

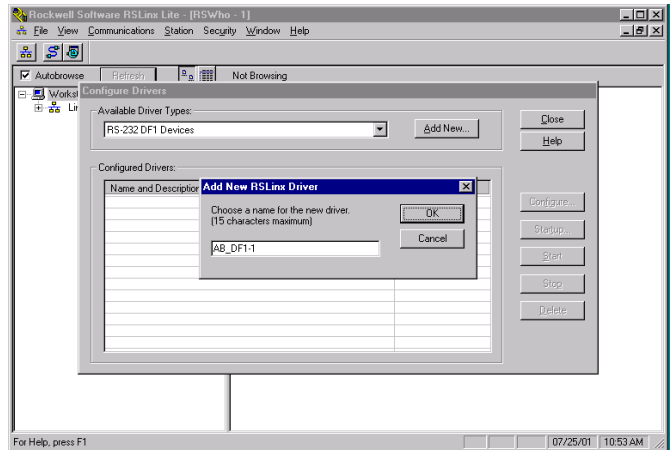

This window will appear.

6. Click on **Auto-Configure** to setup the communication parameters.

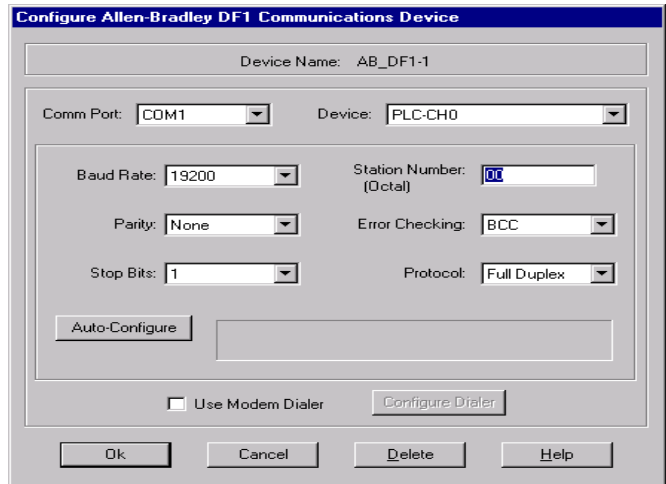

Auto Configuration Successful will appear.

7. Click **OK**.

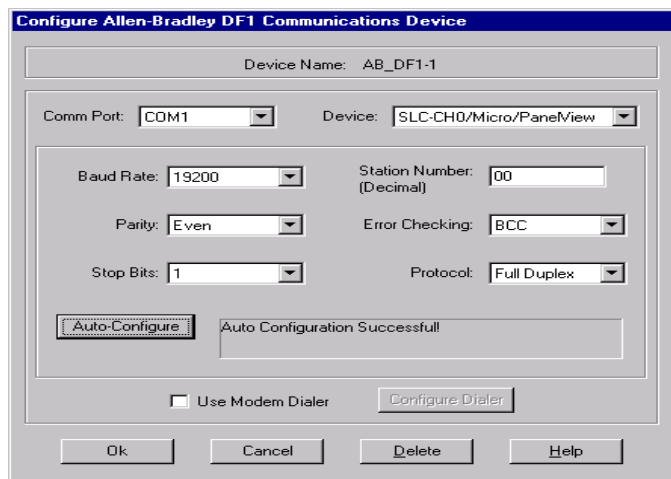

The Configure Drivers window will now appear showing the **Status** as Running.

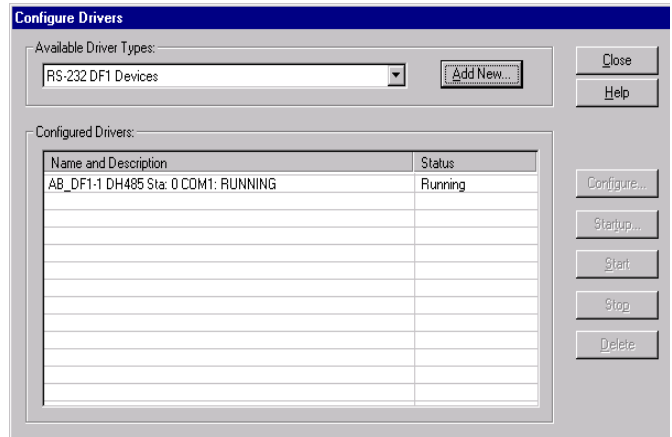

The next step is to add a DeviceNet driver.

8. Click on the down arrowhead, ▼, and select your choice of drivers from the drop-down list.
9. Click on **Add New**.

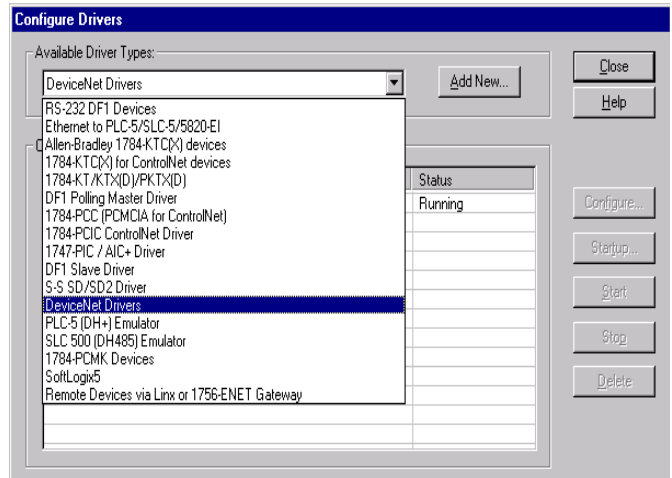

This window will appear.

10. Select the proper driver, then click **Select**.

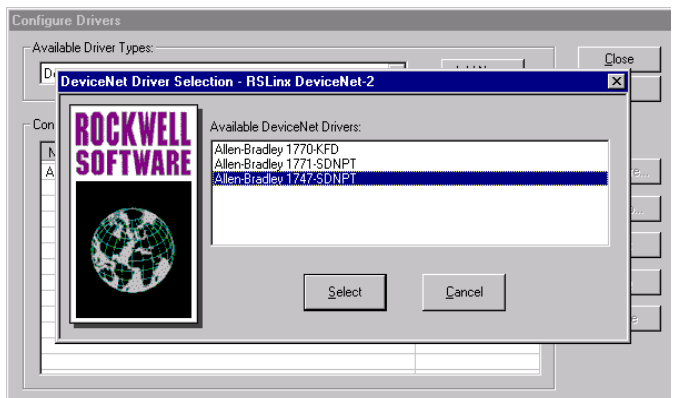

The DeviceNet Interface Configuration window will appear briefly.

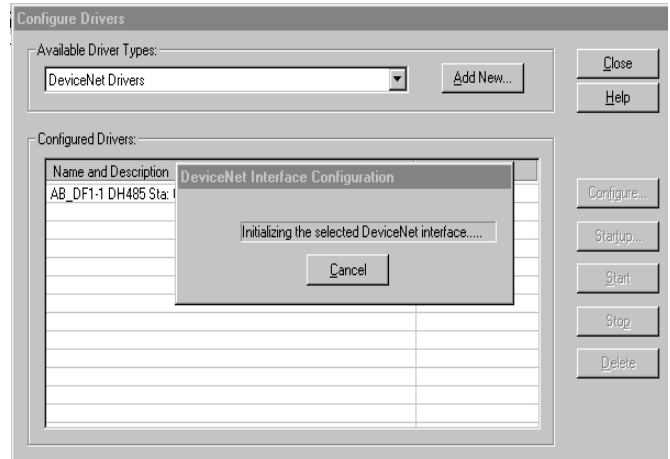

This window will appear for you to setup the pass through port.

Be sure that you select the proper slot where the scanner module is located.

If this does not match, you will need to reconfigure the I/O in RSLogix.

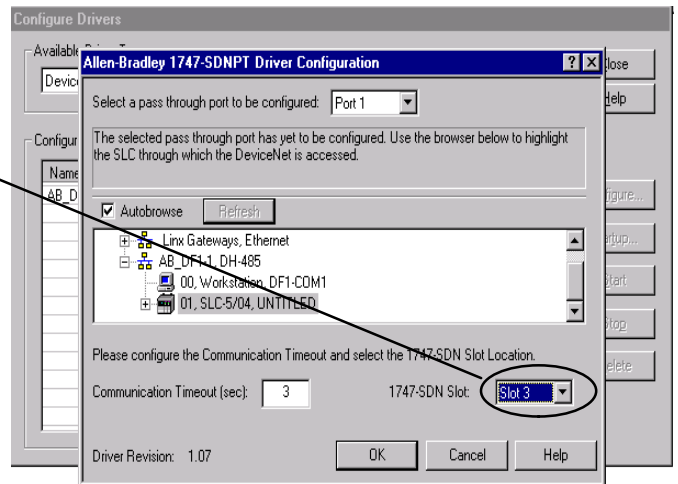

11. Type in a name for the driver, then click **OK**.

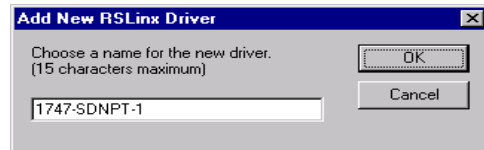

This window will appear indicating that both drivers are Running.

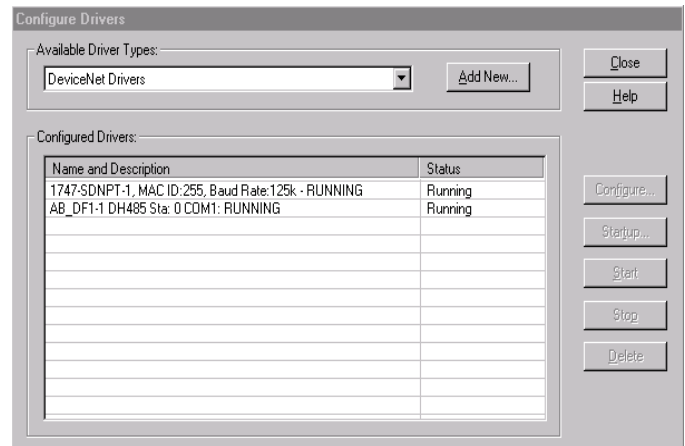

RSLogix

You are ready to connect to the PLC using your RSLogix software.

1. Click on **Communications** and select **Who Active Go Online**.

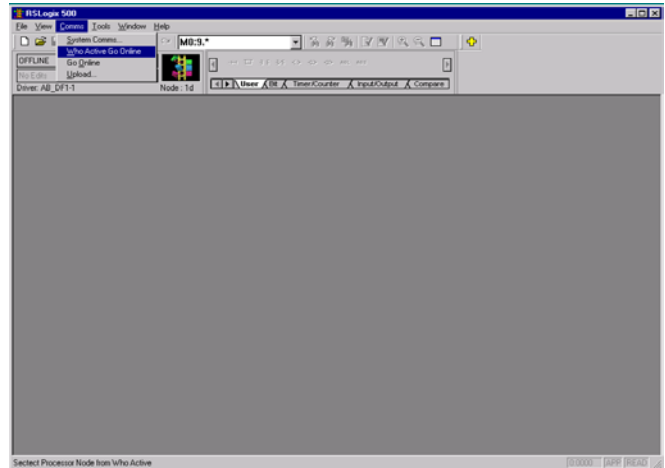

2. When this window appears, select the PLC to connect to.
3. Click **OK**.

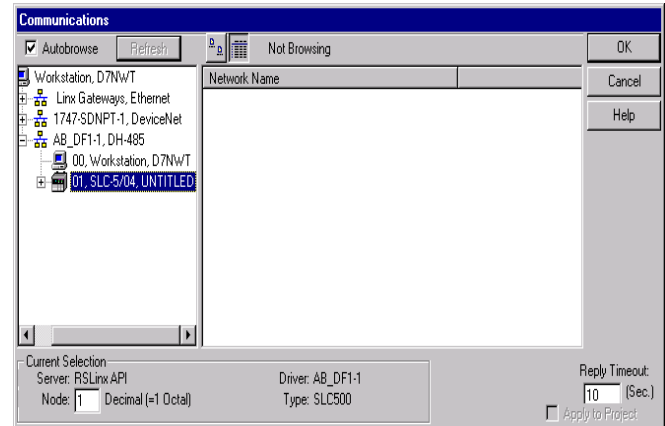

This window will appear with the relay ladder program. You now want to configure the I/O. This must be done **OFFLINE** in order to change the configuration.

4. Select **I/O Configuration**.

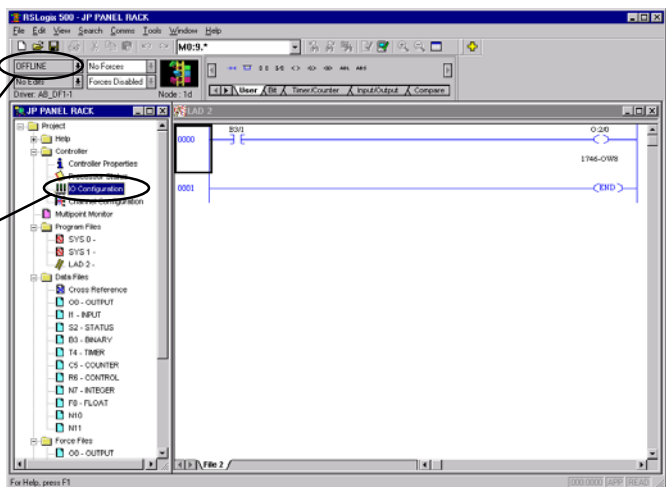

The I/O Configuration window will come into view. When you select the scanner module, verify that it is in the correct slot.

5. Click **Adv Config**.

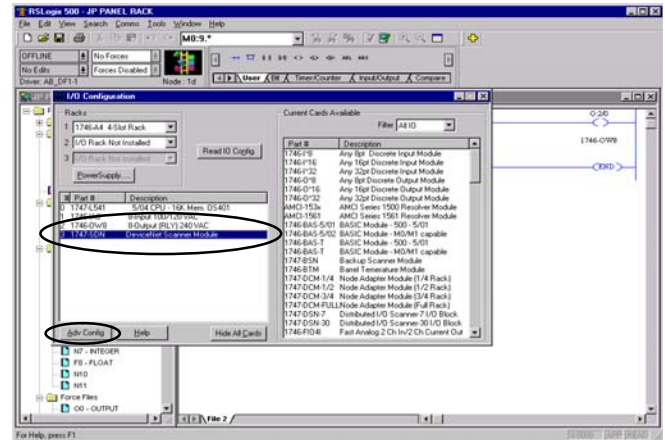

The **Advanced I/O Configuration** window will appear. The **M0** and **M1** Lengths will show the default of 256. Change this to 361.

6. Click **OK**.

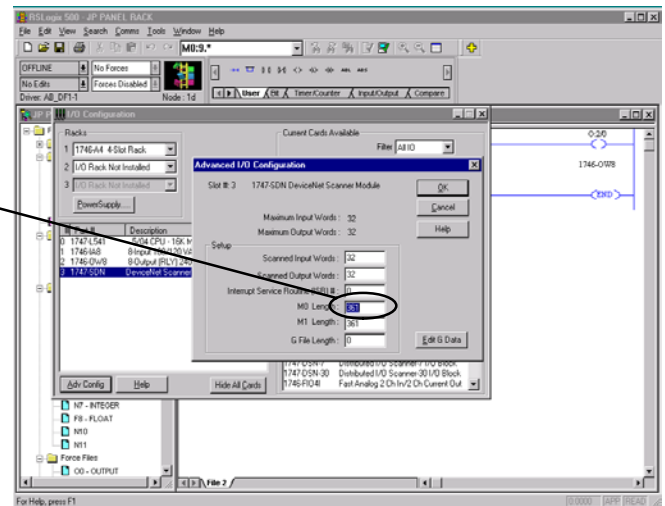

Configure D0-DEVNETS with RSNetWorx

You are now ready to configure the D0-DEVNETS installed in your DL05. First, open RSNetWorx. Look for Koyo Electronics in the hardware tree listed under **Vendor**. Click on the + to show the devices for Koyo. The following example shows two devices, D0-DEVNETS and T1K-DEVNETS.

RSNetWorx opened.

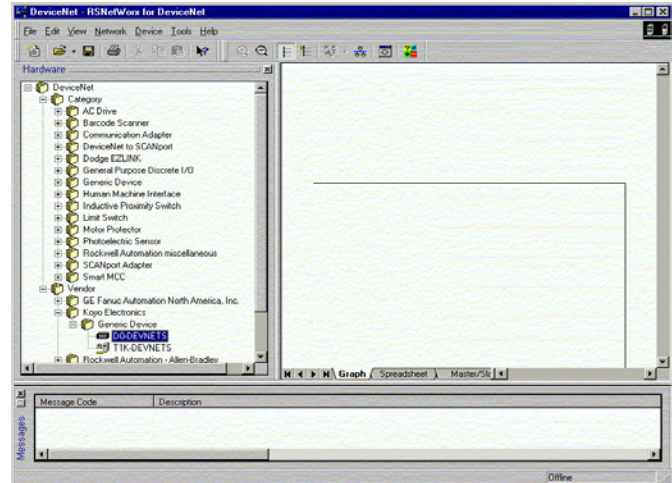

Using the EDS file

If you do not see your device listed, it will need to be added from the EDS file (refer to page 2-7). The following example will guide you through the procedure of installing the device from the EDS file.

Click **Tools** and select **EDS Wizard...**

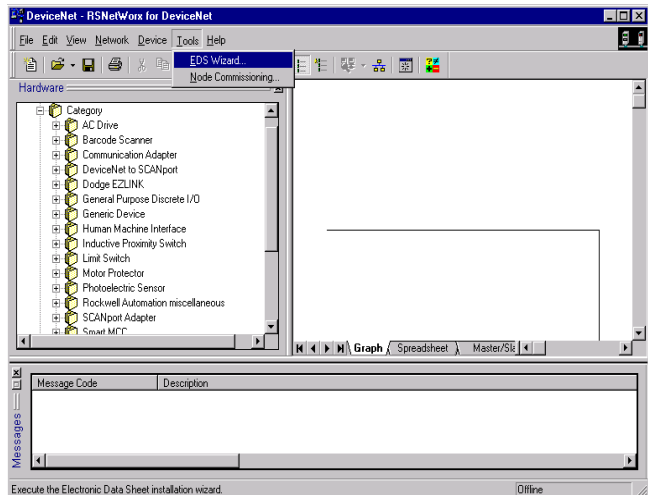

The EDS Wizard will open.
Simply follow the instructions
to register the device.

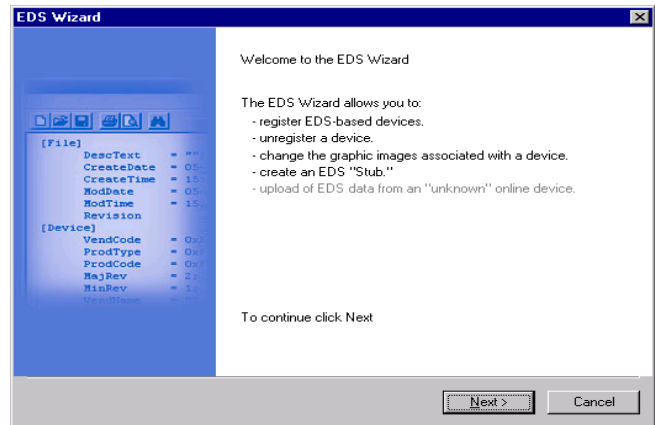

Register the EDS file.

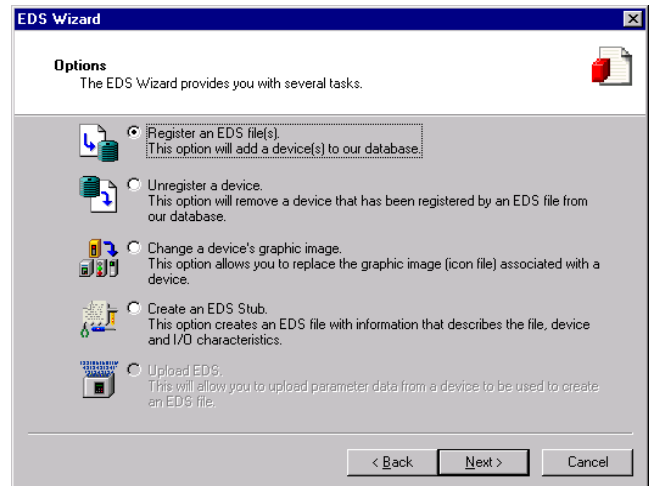

Enter the path for the EDS file.

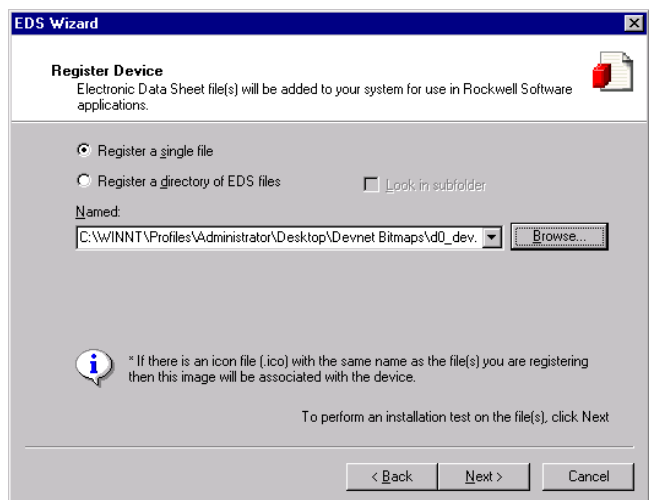

EDS file installation results.

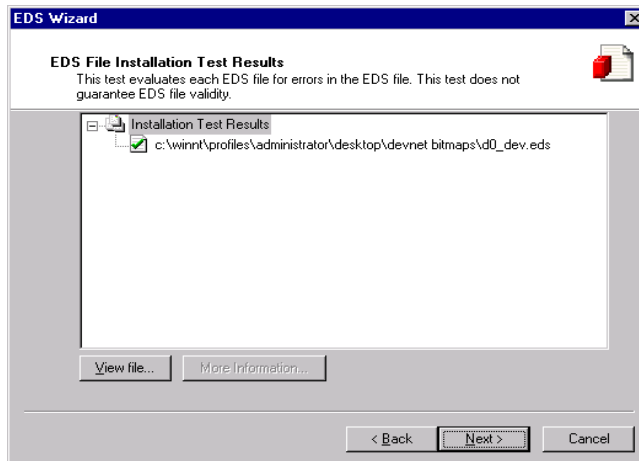

Change the icon image for your device, if you desire to.

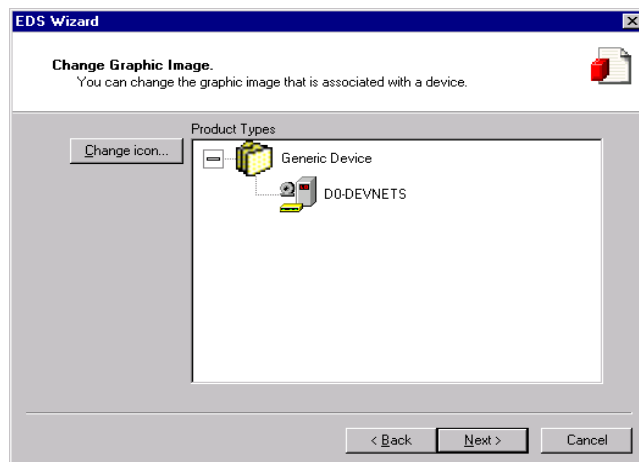

Review what you have done.

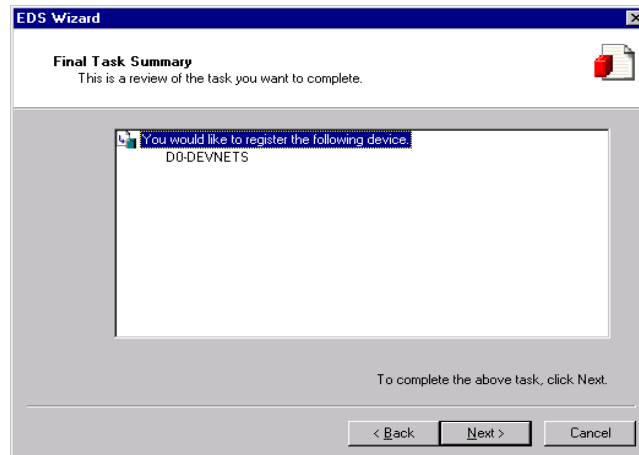

EDS Wizard complete.

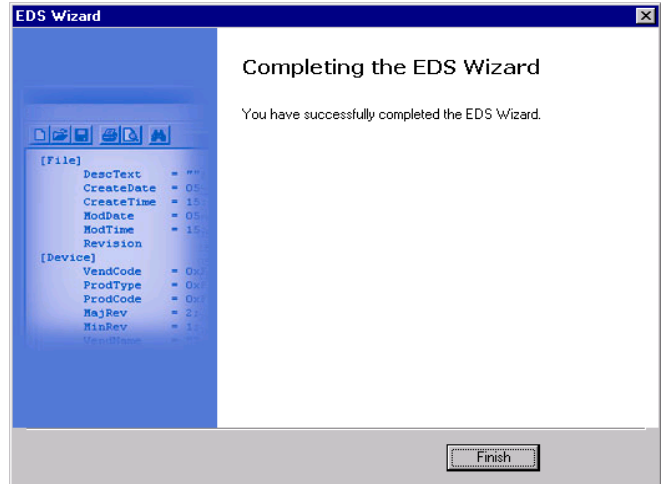

Go on line

You will want to go on line with the network now.

In the main RSNetwork window,

1. Click on **Network** to select **Online**.

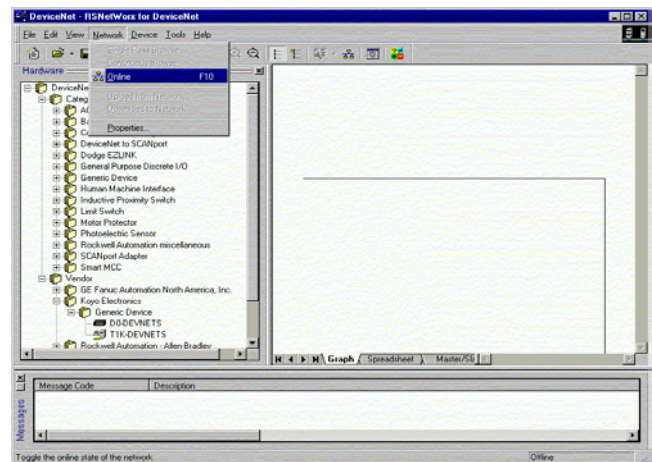

2. Select your network from the pop-up window.
3. Click **OK**.

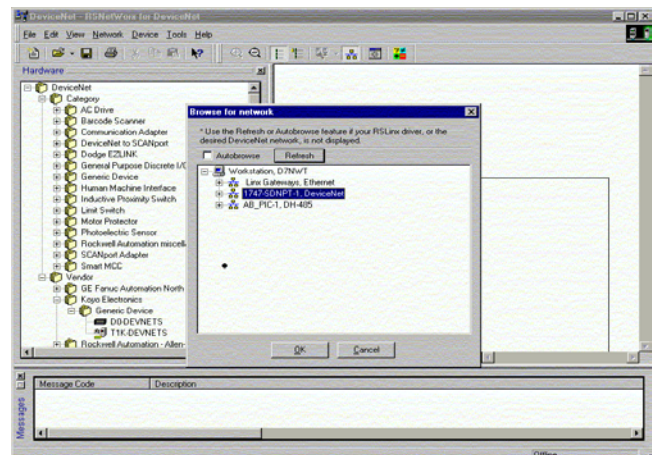

This message will appear.

4. Click **OK**.



Browsing network message.

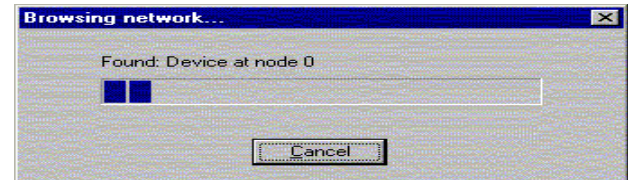

Once the nodes are found, each node icon will appear on the RSNetworx window.

After all of the nodes have been found, browse can be cancelled.

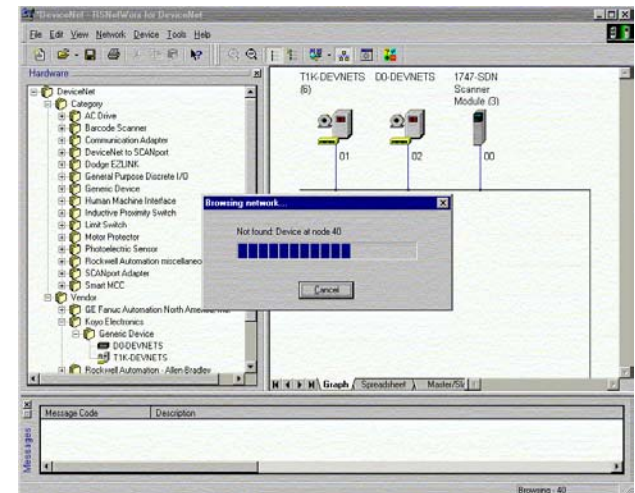

Set up I/O parameters

Now you can set up the I/O parameters for the devices. The scanner needs to be configured first. This is done by accessing the scanner properties.

1. Select the scanner module.

This can be done in two different ways.

2. Click on the scanner name, then right click the mouse,

or

3. Click on **Device**, then click on properties in the pop-up window.

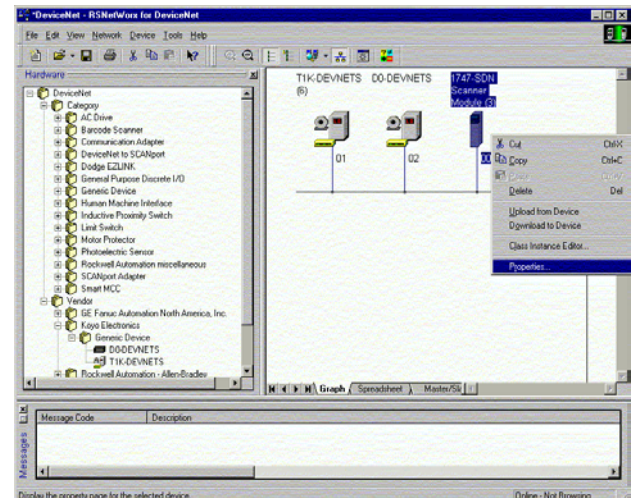

The properties window will appear.

4. Click **Module**.

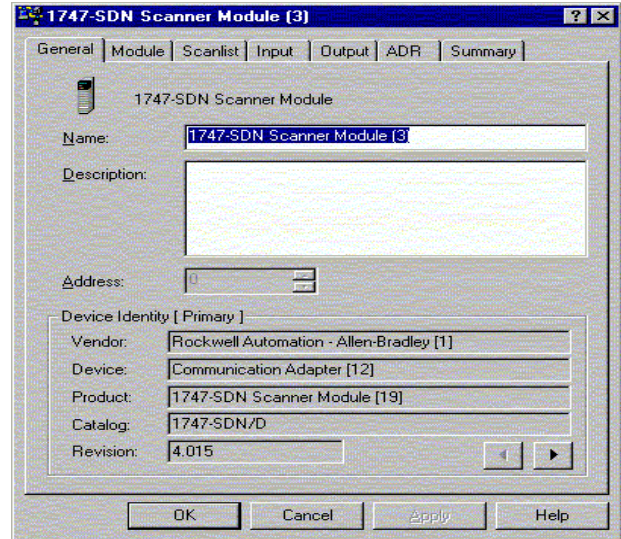

5. Click **Upload**.

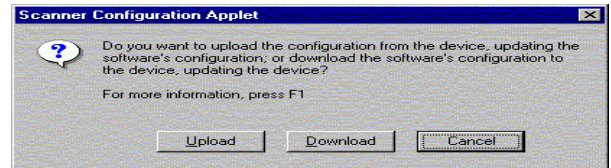

Uploading network information.

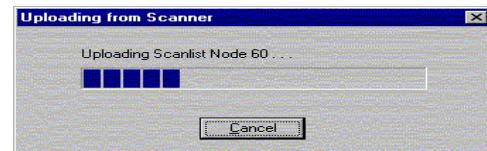

Note: Do not cancel. The entire network data must be allowed to upload.



The data appears.

6. Select the correct slot number which the DeviceNet scanner module is residing.

7. Click **Scanlist**.

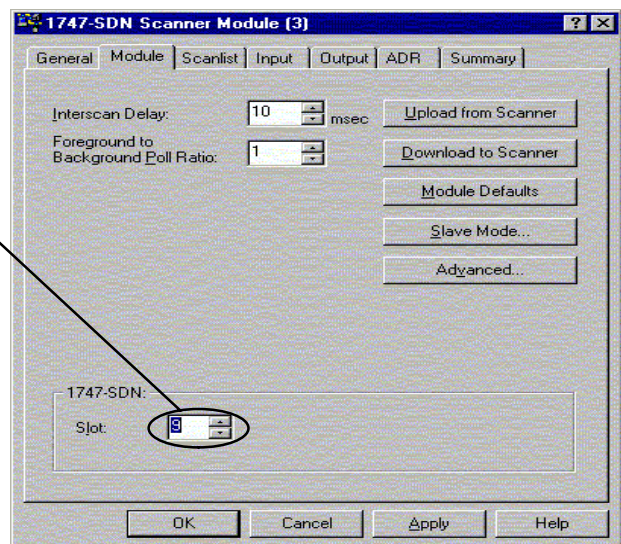

If the node that you want is not in the Scanlist, it needs to be moved to the list.

8. Highlight D0-DEVNETS
9. Click the right arrow.

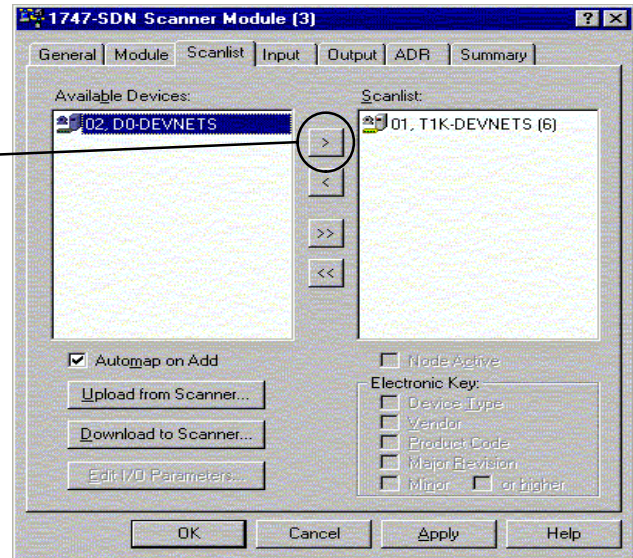

Now that D0-DEVNETS is in the list, be sure that it is selected.

10. Click **Edit I/O Parameters**.

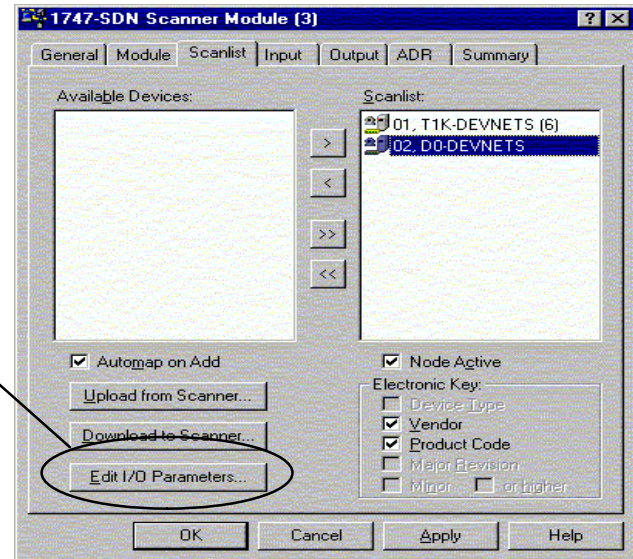

11. Set the **Rx Size** and the **Tx Size** to match the polled data size for the number of I/O bytes (refer to tables in Appendix C).
12. Click **OK**.

Refer to page G-18 (Set Class Instance Attribute) if the total number of Rx and Tx bytes are not known.

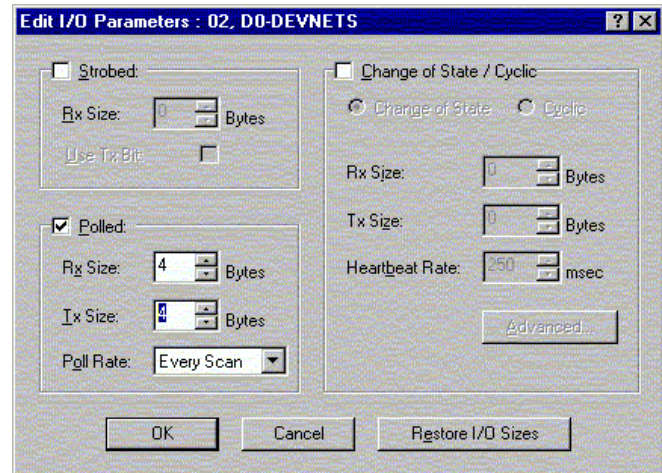

This window will appear.
13. Click **Yes**.

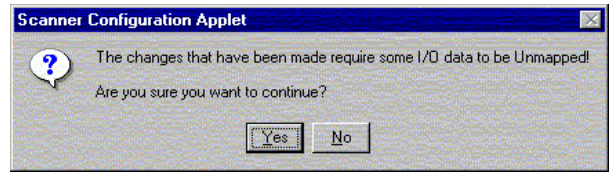

Map the nodes

Map each node.

1. Click the **Input** tab in the properties window.

Be sure that D0-DEVNETS is selected.

2. Select **Discrete** for **Memory**, and **0** for **Start Word**.
3. Click **AutoMap**.

NOTE: M file is used with explicit messaging.

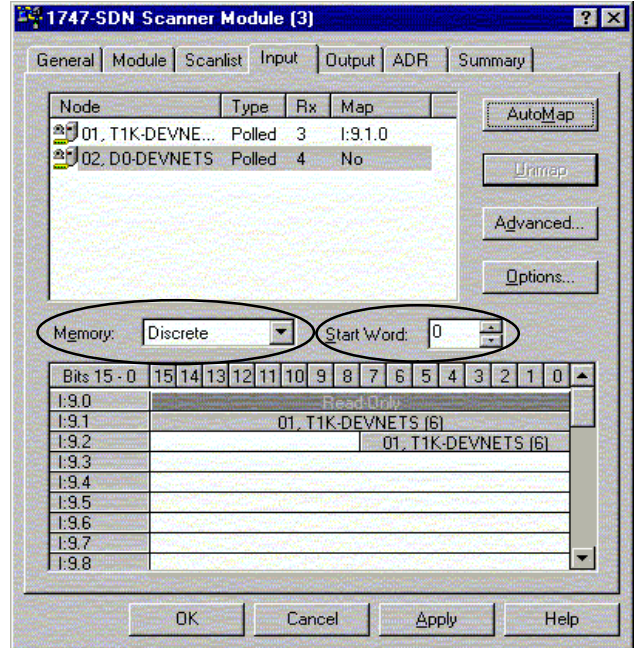

At the completion of the input AutoMapping, the window will look like this example. The D0-DEVNETS node is now shown.

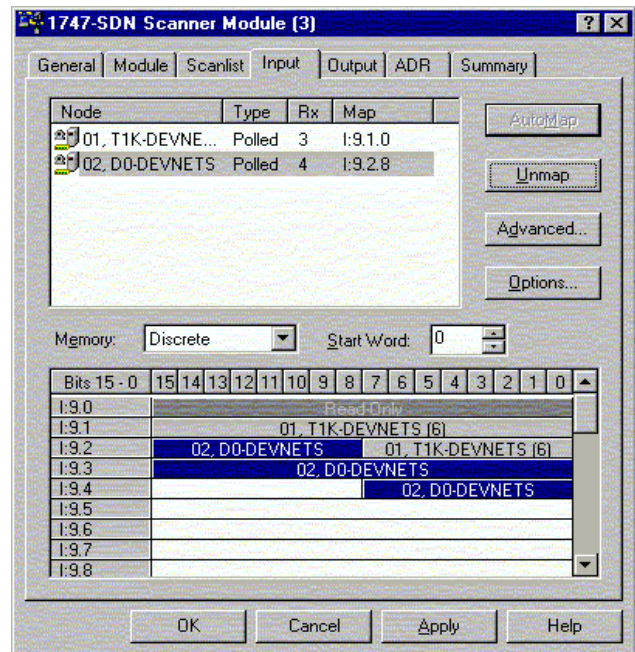

Now, map the outputs just the way you mapped the inputs. This time:

1. Click the **Output** tab in the properties window.

Be sure that D0-DEVNETS is selected.

2. Select **Discrete** for **Memory**, and **0** for **Start Word**.
3. Click **AutoMap**.

At the completion of the output AutoMapping, the window will appear like this example. The D0-DEVNETS node is now shown.

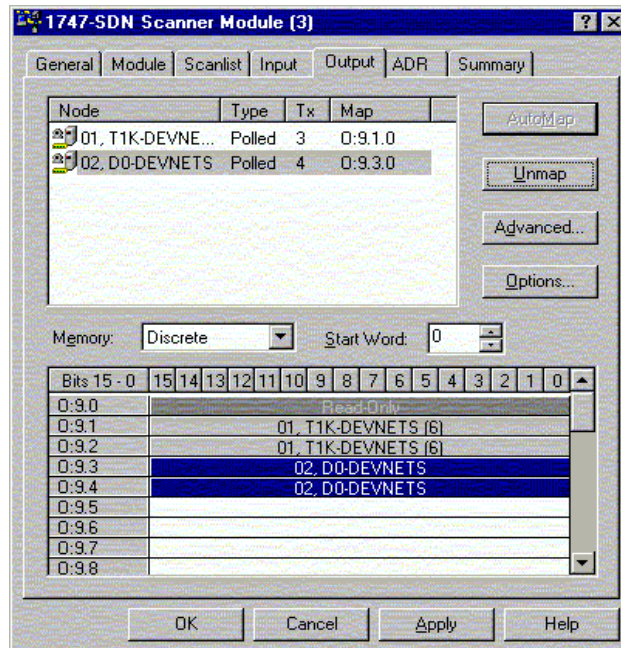
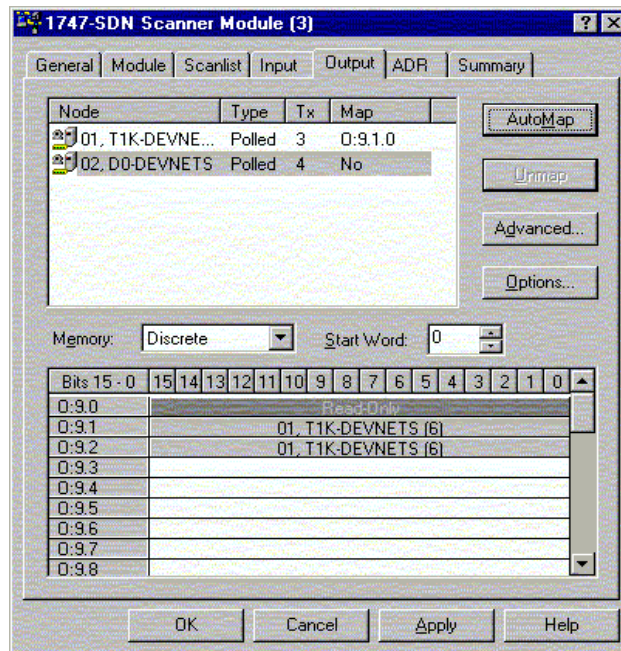

Download the scanlist to the scanner.

1. Select the **Scanlist** tab in the properties window.
2. Select **Download to Scanner**.

In the pop-up window:

3. Check **All Records**, then
4. Click **Download**.

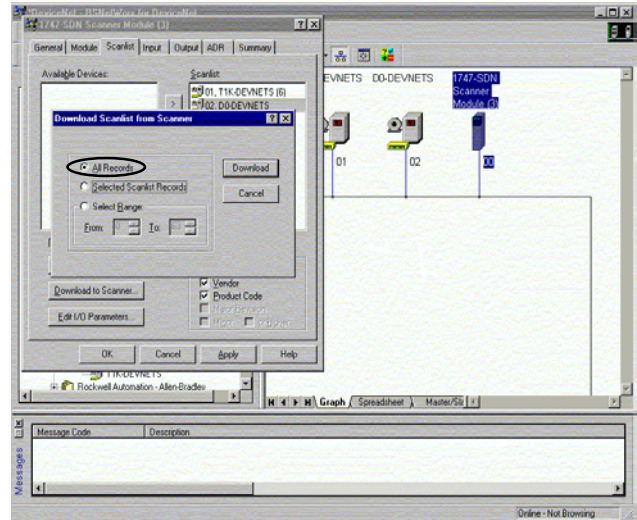

Note: Verify that the processor is in program mode before downloading the scanlist.

This is an error message that may appear.



When the download indication ends, download is complete.

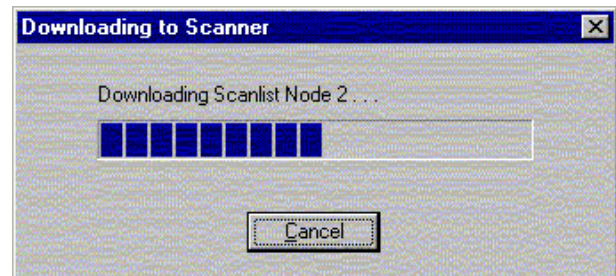

Set Class Instance Attribute

Use the Service Class Instance Attribute Editor to set the I/O to read and write to the DL05/06.

1. Select the D0-DEVNETS node.
2. Select **Device**
or,
3. Right click on the node symbol in the RSNetWorx window.
4. Select **Class Instance Editor** in the pop-up window.

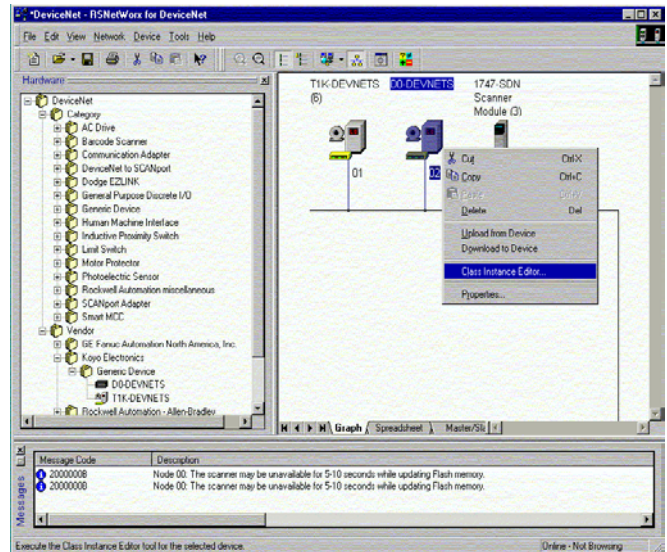

5. Setup input attributes in this window.

Object Address must be set to: **Class = 5, Instance = 2, Attribute = 7**

Size = Word (2 bytes).

6. Click **Execute**

Read the data here.

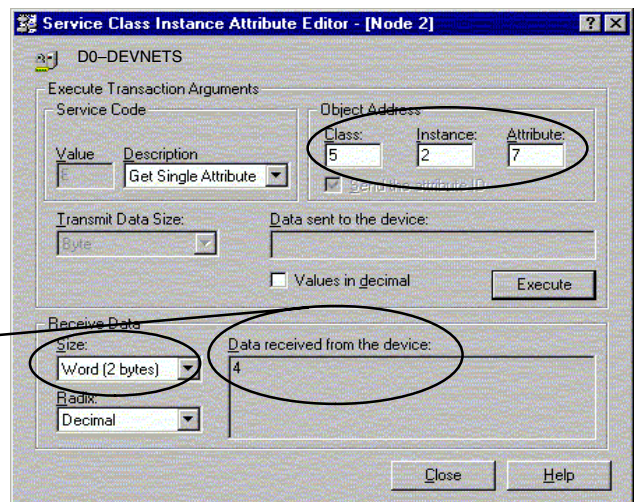

Setup output attributes in this window.

Object Address must be set to:

Class = 5, Instance = 2, Attribute = 8

Size = Word (2 bytes).

7. Click **Execute**

Read the data here.

